

Installation & Service
C22-991-2401A

Hydra-Cell[®]

INDUSTRIAL VALVES

Models:
C22D, C23D, C24D

Bypass Pressure Regulating Valves
with BSPT Threaded Ports

IMPORTANT

Record your pump model number and serial number here for easy reference:

Model No. _____

Serial No. _____

Date of Purchase _____

When ordering parts or making inquiries about this pump, please mention the model and serial numbers.

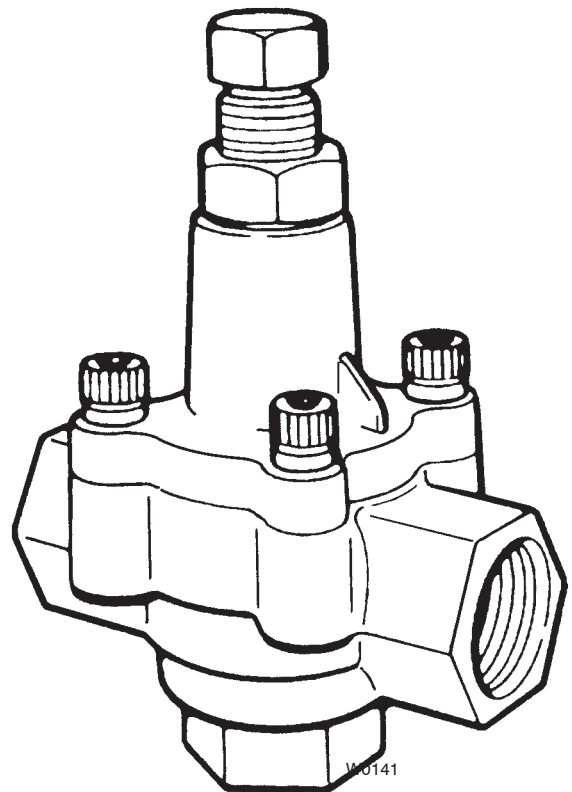

C22D/23D/24D Contents

	Page
Specifications	2
Installation	3
Disc Arrangement	5
C22-D Parts	6
C23-D Parts	8
C24-D Parts	10
Repair & Troubleshooting.....	11
Warranty.....	12

C22D/23D/24D Specifications

Specifications

Capacity:	Maximum	Minimum
	I/min	I/min
C22D	38	11
C23D	76	11
C24D	152	19

Pressure Range (bar): Model Configuration

	DA	DB	DC	DE
C22D	5-34	34-69	69-103	103-172
C23D	5-34	34-69	69-103	103-172
C24D	5-34	34-69	69-103	—

Max Temperature: 200°F

Inlet and Outlet Ports:

C22D	3/4" BSPT
C23D	1" BSPT
C24D	1-1/4" BSPT

Dimensions: (H x W x D)

C22DA, DB, DC	152.4 x 86.4 x 55.9 mm
C22DE	163.6 x 86.4 x 55.9 mm
C23DA, DB, DC	178 x 122 x 71.1 mm
C23DE	88 x 122 x 71.1 mm
C24DA, DB, DC	229 x 137.2 x 83.8 mm

Weight

C22D	1.3 kg
C23D	2.7 kg
C24D	4.5 kg



C22D/23D/24D Installation

Location

The Bypass Pressure Regulating Valve prevents system pressure from exceeding a preset maximum. As the system approaches this maximum pressure, excess fluid is bypassed (to a supply tank, or to the pump inlet). This prevents overpressurization and system failures.

Install the regulating valve between the pump outlet (as close to the pump as possible) and any shut-off device in the discharge plumbing. It may be located **in** the discharge line, or **off**-line:

- If in-line, use either of the horizontal ports as the inlet and the other as the outlet;
- If off-line, use either of the horizontal ports as the inlet and plug the other one.

The **bottom** port is always the bypass port.

Mounting Position

The preferred mounting position is vertical with the adjusting bolt at the top.

Connections

For best operation, the bypass line should return to the supply tank. If you must plumb the bypass line back to the pump inlet instead, have it enter the inlet line as far from the pump as possible. Contact the pump manufacturer, as a pressure regulator may be required in the pump inlet.

The bypass line should be as large as the ports of the regulating valve. Do **not** install shutoff valves or other restrictions.

Install a high-quality industrial pressure gauge in the discharge system to monitor system pressure. Failure to do so may result in overpressurization and premature failure of pumping system components.

For smoothest operation and minimal pressure spiking when the discharge system is closed (closed gun, plugged nozzles, valve closed), about 10% of the rated flow of the regulating valve should be bypassed at all times.

Example: With the C22D valve (rated at 38 l./m), 3 l./m should be bypassing at all times during operation. If the desired spray gun delivery is 22 l./m, then the pump should deliver 26 l./m (22 l./m to the gun and 4 l./m to be bypassed). The nozzle orifices should be properly sized for 22 l./m delivery at the desired pressure; the pump RPM for 26 l./m; and the pump HP for 26 l./m at the bypass pressure (bypass pressure is higher than nozzle pressure).

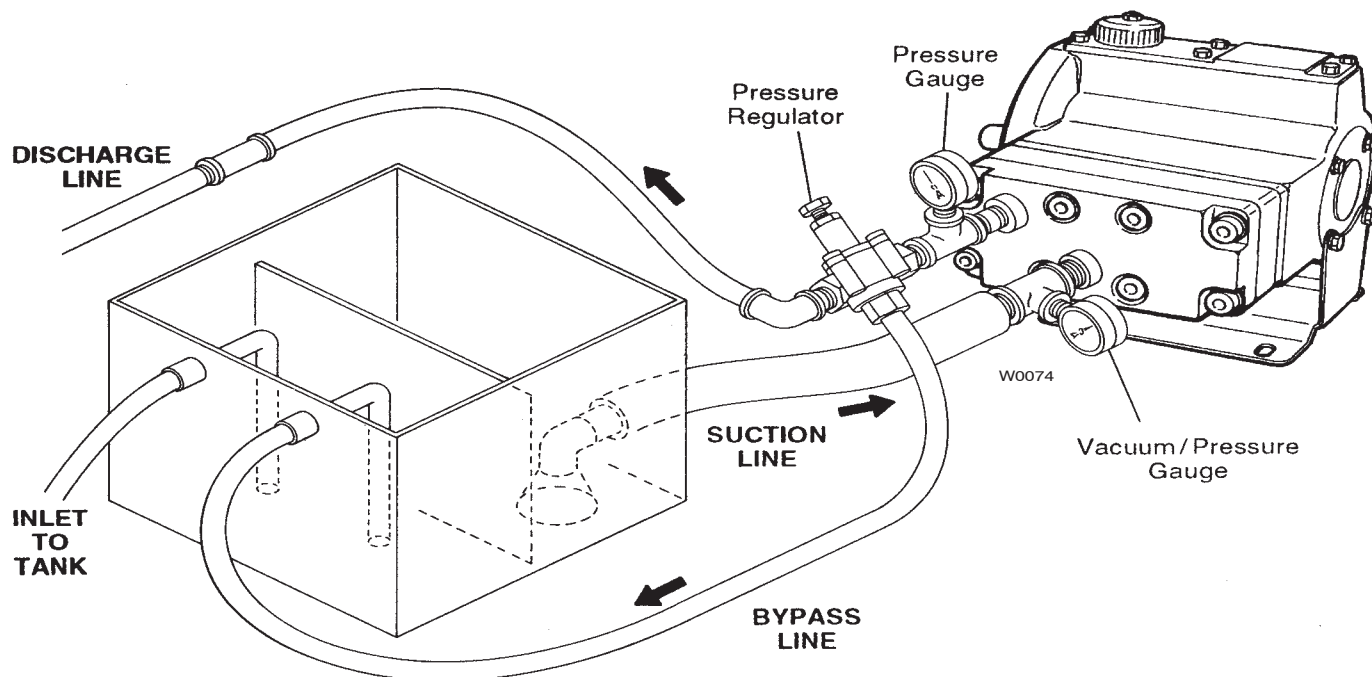

C22D/23D/24D Installation

Pressure Adjustment

Systems with Shutoff Guns or Valves

1. Turn off the system.
2. Turn the adjusting nut counterclockwise until there is no longer any pressure on the springs in the regulating valve.
3. Close the discharge line.
4. Be sure the piping and all valves and nozzles are open.
With an accurate pressure gauge installed in the system, start the system and let it run for a few minutes to remove any air.
5. When all air has been removed, begin turning the adjusting nut clockwise until the desired bypass pressure is reached.
Do not exceed the maximum rated pressure of the pump or the regulating valve!
6. Open and close the discharge line 3 or 4 times. Re-check the bypass pressure each time, and readjust if necessary. Turn the adjusting nut clockwise to increase or counterclockwise to reduce the pressure.
7. Check that the fluid bypass is continuous and adequate. With guns or valves open, you should be bypassing about 10% of the rated flow of the regulating valve (see the Example above). If the system discharge pressure is less than desired when 10% of the flow is bypassing, check the pump speed and delivery and the size of the nozzle or system orifice.
8. When both the bypass pressure and the flow have been set, turn the locknut clockwise to lock in the adjustment.

Systems without Shutoff Guns or Valves

Note: When making this adjustment, you must be able to observe the amount of fluid being bypassed.

1. Turn off the system.
2. Turn the adjusting nut counterclockwise until there is no longer any pressure on the springs in the regulating valve.
3. With an accurate pressure gauge installed in the system start the system and let it run for a few minutes to remove any air. The full flow of the pump should be bypassing.
4. Be sure all nozzles are open.
5. When all air has been removed, begin turning the adjusting nut clockwise until the desired bypass pressure is reached, or until no fluid is being bypassed — whichever occurs first.
Do not exceed the maximum rated pressure of the pump or the regulating valve!
6. If the system discharge pressure is less than desired, check the pump speed and delivery and the size of the nozzle or system orifice.
7. When both the bypass pressure and the flow have been set, turn the locknut clockwise to lock in the adjustment.

C22D

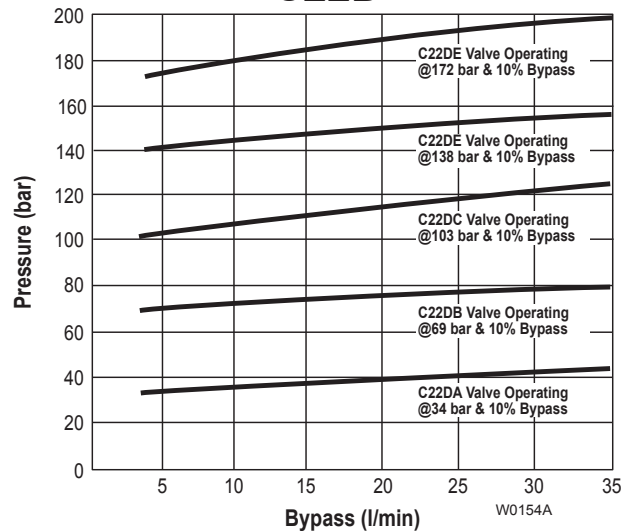

C23D

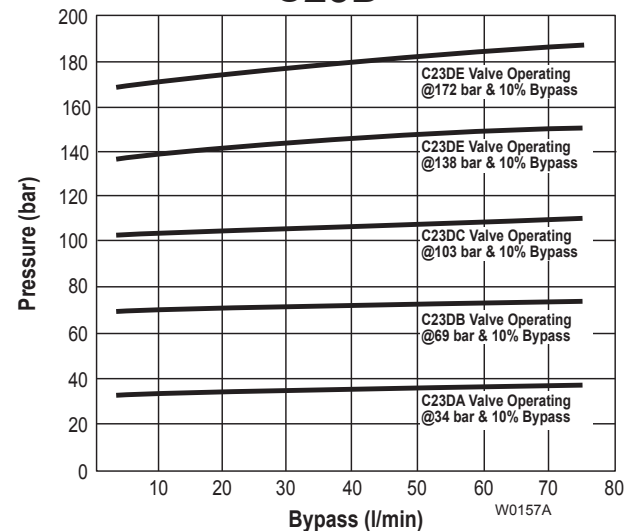

C24D

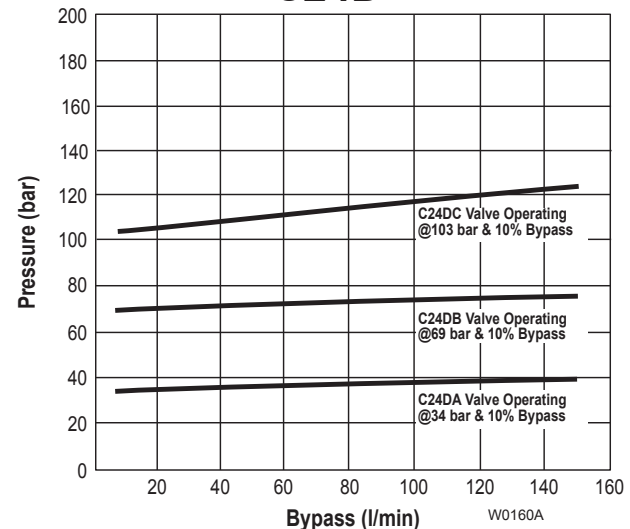

C22D/23D/24D Spring Disc Arrangement

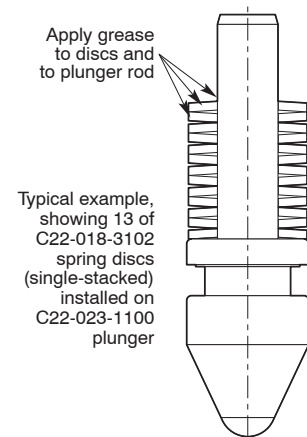
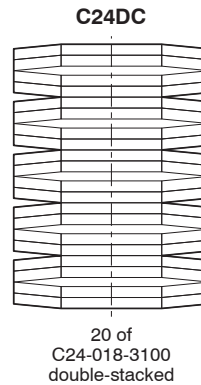
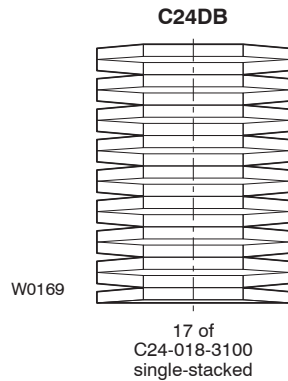
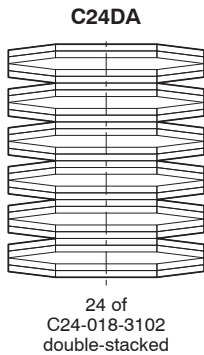
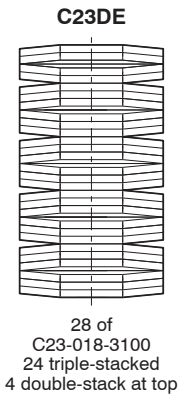
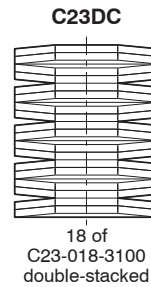
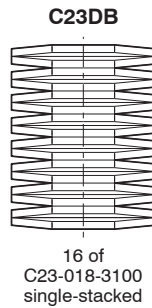
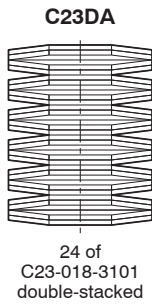
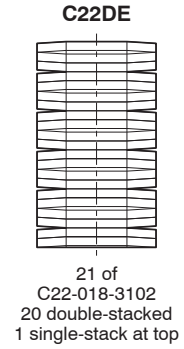
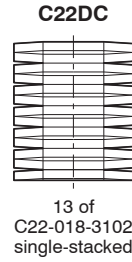
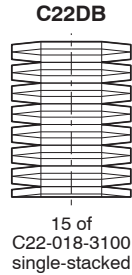
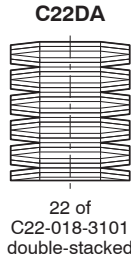

Spring Disc Size and Arrangement

Valve Model	I./m	bar	Disc Size OD x ID x Thickness	Quantity Used
C22DA	11-38	5-34	20 x 10.2 x 0.8 mm	22 (double stack)
C22DB	11-38	34-69	20 x 10.2 x 1.2 mm	15 (single stack)
C22DC	11-38	69-103	20 x 10.2 x 1.5 mm	13 (single stack)
C22DE	11-38	103-172	20 x 10.2 x 1.5 mm	1 (single stack); 20 (double stack)
C23DA	11-76	5-34	28 x 12.2 x 1.0 mm	24 (double stack)
C23DB	11-76	34-69	28 x 12.2 x 1.5 mm	16 (single stack)
C23DC	11-76	69-103	28 x 12.2 x 1.5 mm	18 (double stack)
C23DE	11-76	103-172	28 x 12.2 x 1.5 mm	4 (double stack); 24 (triple stack)
C24DA	19-162	5-34	35.5 x 18.3 x 1.2 mm	24 (double stack)
C24DB	19-162	34-69	35.5 x 18.3 x 2.0 mm	17 (single stack)
C24DC	19-162	69-103	35.5 x 18.3 x 2.0 mm	20 (double stack)

C22D Parts



C22-DA, C22-DB, and C22-DC

Brass Body

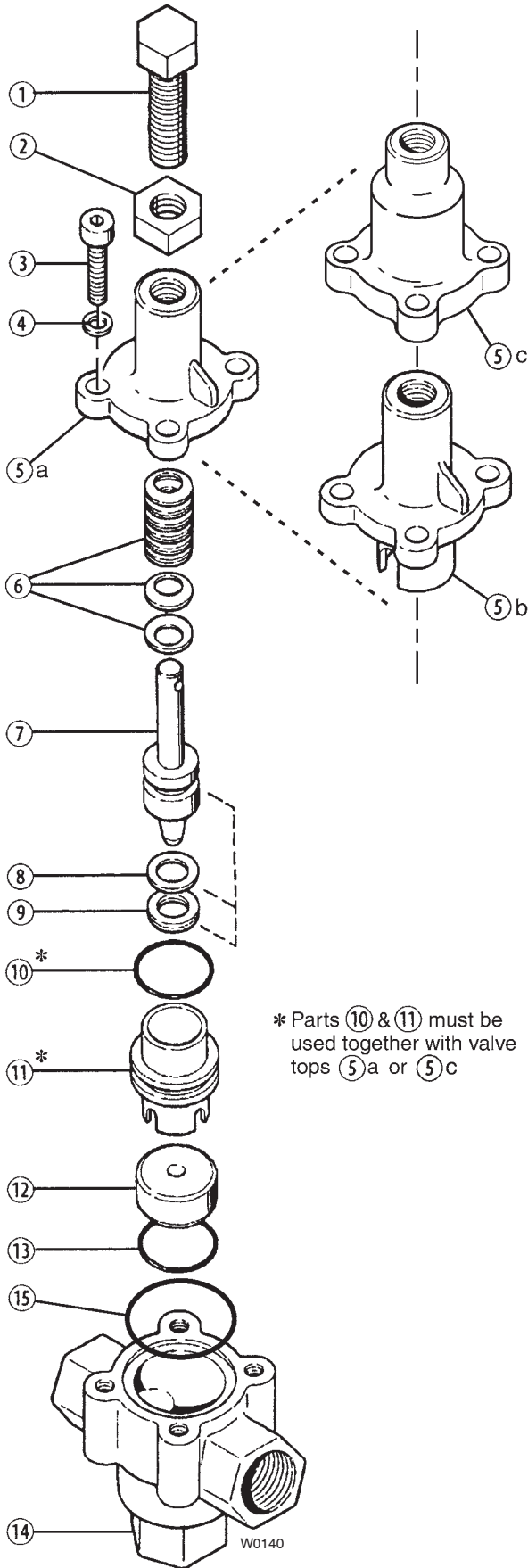

Ref. No.	Part Number	Description	Quantity/ Pump
1	C22-004-1005	Adjusting bolt, Pressure range A	1
	C22-004-1006	Adjusting bolt, Pressure range B, C....	1
2	C22-005-1000	Jam nut.....	1
3	C22-015-2004	Screw, Cap, M8 x 1.25 x 25 mm	4
4	C22-014-2000	Lockwasher	4
5a	C22-003-1002	Valve top, Unwetted	1
5b	C22-003-1000	Valve top, Brass	1
6	C22-018-3100	Spring disc, 20 x 10.2 x 1.2 mm.....	**
	C22-018-3101	Spring disc, 20 x 10.2 x 0.8 mm.....	**
	C22-018-3102	Spring disc, 20 x 10.2 x 1.5 mm.....	**
7	C22-023-1100	Plunger Assembly, 316 SST.....	1
	C22-023-1101	Plunger Assembly, SST, with tungsten carbide ball	1
	C22-023-1103	Plunger Assembly, 17-4 PH SST	1
	C22-023-1117	Plunger Assembly, Hastelloy C-276....	1
8	C22-013-2110	Seal, Back-up, Buna-N.....	1
	C22-013-2117	Seal, Back-up, UHMW polyethylene...1	1
	C22-013-2118	Seal, back-up, PTFE	1
9	C22-012-2110	Seal, Buna-N.....	1
	C22-012-2111	Seal, Viton	1
	C22-012-2113	Seal, EPDM.....	1
	C22-012-2115	Seal, Urethane	1
10*	C22-011-2110	O-ring, Sleeve, Buna-N.....	1
	C22-011-2111	O-ring, Sleeve, Viton.....	1
	C22-011-2113	O-ring, Sleeve, EPDM.....	1
11*	C22-024-1010	Sleeve, 316 SST.....	1
	C22-024-1017	Sleeve, Hastelloy C-276.....	1
12	C22-006-1000	Seat, 316 SST	1
	C22-006-1001	Seat, 17-4 HT	1
	C22-006-1002	Seat, Tungsten carbide	1
	C22-006-1017	Seat, Hastelloy C-276	1
13	C22-010-2110	O-ring, Valve seat, Buna-N.....	1
	C22-010-2111	O-ring, Valve seat, Viton	1
	C22-010-2113	O-ring, Valve seat, EPDM.....	1
14	C22-002-1006	Valve body, Brass, BSPT	1
15	C22-011-2110	O-ring, Buna-N.....	1
	C22-011-2111	O-ring, Viton	1
	C22-011-2113	O-ring, EPDM.....	1
-	C22-022-2402	Nameplate, C22, blank (specify model & serial no.)	1
-	A01-115-3400	Grease, Regulator valve spring, 1/4 ounce.....	1

** See page 5 for spring disc quantities and arrangements.

C22D Parts



C22-DA, C22-DB, and C22-DC

Stainless Steel Body Nickel Alloy Body

Ref. No.	Part Number	Description	Quantity/ Pump
1	C22-004-1005	Adjusting bolt, Pressure range A	1
	C22-004-1006	Adjusting bolt, Pressure range B, C	1
2	C22-005-1000	Jam nut	1
3	C22-015-2004	Screw, Cap, M8 x 1.25 x 25 mm	4
4	C22-014-2000	Lockwasher	4
5a	C22-003-1002	Valve top, Nonwetted	1
6	C22-018-3100	Spring disc, 20 x 10.2 x 1.2 mm	**
	C22-018-3101	Spring disc, 20 x 10.2 x 0.8 mm	**
	C22-018-3102	Spring disc, 20 x 10.2 x 1.5 mm	**
7	C22-023-1000	Plunger Assembly, 316 SST	1
	C22-023-1001	Plunger Assembly, SST, with tungsten carbide ball	1
	C22-023-1003	Plunger Assembly, 17-4 PH SST	1
	C22-023-1007	Plunger Assembly, Hastelloy C-276	1
8	C22-013-2110	Seal, Back-up, Buna-N	1
	C22-013-2117	Seal, Back-up, UHMW polyethylene	1
	C22-013-2118	Seal, Back-up, PTFE	1
9	C22-012-2110	Seal, Buna-N	1
	C22-012-2111	Seal, Viton	1
	C22-012-2113	Seal, EPDM	1
	C22-012-2115	Seal, Urethane	1
10*	C22-016-2110	O-ring, Sleeve, Buna-N	1
	C22-016-2111	O-ring, Sleeve, Viton	1
	C22-016-2113	O-ring, Sleeve, EPDM	1
11*	C22-024-1010	Sleeve, 316 SST	1
	C22-024-1017	Sleeve, Hastelloy C-276	1
12	C22-006-1000	Seat, 316 SST	1
	C22-006-1001	Seat, 17-4 HT	1
	C22-006-1002	Seat, Tungsten carbide	1
	C22-006-1017	Seat, Hastelloy C-276	1
13	C22-010-2110	O-ring, Valve seat, Buna-N	1
	C22-010-2111	O-ring, Valve seat, Viton	1
	C22-010-2113	O-ring, Valve seat, EPDM	1
14	C22-002-1004	Valve body, 316 SST, BSPT	1
	C22-002-1018	Valve body, Nickel alloy C series, BSPT	1
15	C22-011-2110	O-ring, Buna-N	1
	C22-011-2111	O-ring, Viton	1
	C22-011-2113	O-ring, EPDM	1
-	C22-022-2402	Nameplate, C22, blank (specify model & serial no.)	1
-	A01-115-3400	Grease, Regulator valve spring, 1/4 ounce	

** See page 5 for spring disc quantities and arrangements.

C22-DE

Brass Body Stainless Steel Body Nickel Alloy Body

Ref. No.	Part Number	Description	Quantity/ Pump
1	C22-004-1008	Adjusting bolt, Pressure range E	1
2	C22-005-1000	Jam nut	1
3	C22-015-2014	Screw, Cap, M8 x 1.25 x 25 mm	4
4	C22-014-2000	Lockwasher	4
5c	C22-003-1003	Valve top, Non-wetted, 172 bar	1
6	C22-018-3102	Spring disc, 20 x 10.2 x 1.5 mm	21
7	C22-023-1000	Plunger Assembly, 316 SST	1
	C22-023-1003	Plunger Assembly, 17-4 PH SST	1
	C22-023-1007	Plunger Assembly, Hastelloy C-276	1
8	C22-013-2110	Seal, Back-up, Buna-N	1
	C22-013-2118	Seal, Back-up, PTFE	1
9	C22-012-2110	Seal, Buna-N	1
	C22-012-2111	Seal, Viton	1
10*	C22-016-2110	O-ring, Sleeve, Buna-N	1
	C22-016-2111	O-ring, Sleeve, Viton	1
11*	C22-024-1010	Sleeve, 316 SST	1
	C22-024-1017	Sleeve, Hastelloy C-276	1
12	C22-006-1000	Seat, 316 SST	1
	C22-006-1001	Seat, 17-4 HT	1
	C22-006-1017	Seat, Hastelloy C-276	1
13	C22-010-2110	O-ring, Valve seat, Buna-N	1
	C22-010-2111	O-ring, Valve seat, Viton	1
14	C22-002-1006	Valve body, Brass, BSPT	1
	C22-002-1004	Valve body, 316 SST, BSPT	1
	C22-002-1018	Valve body, Nickel alloy C series, BSPT	1
15	C22-011-2110	O-ring, Buna-N	1
	C22-011-2111	O-ring, Viton	1
-	C22-022-2402	Nameplate, C22, blank (specify model & serial no.)	1
-	A01-115-3400	Grease, Regulator valve spring, 1/4 ounce	

C23D Parts

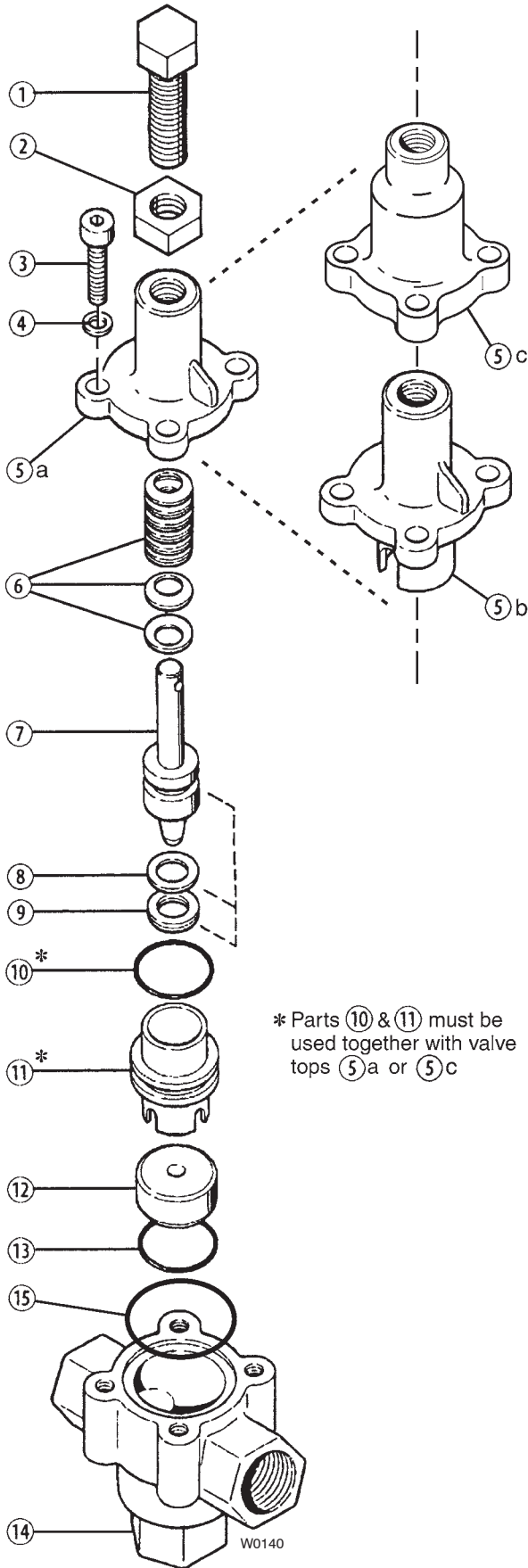

* Parts ⑩ & ⑪ must be used together with valve tops ⑤a or ⑤c

C23-DA, C23-DB, and C23-DC

Brass Body

Ref. No.	Part Number	Description	Quantity/ Pump
1	C23-004-1005	Adjusting bolt, Pressure range A	1
	C23-004-1006	Adjusting bolt, Pressure range B	1
	C23-004-1007	Adjusting bolt, Pressure range C	1
2	C23-005-1000	Jam nut.....	1
3	G10-087-2010	Screw, Cap, M10 x 1.5 x 30 mm.....	4
4	G25-048-2010	Lockwasher, M10	4
5a	C23-003-1002	Valve top. Nonwetted	1
5b	C23-003-1000	Valve top, Brass	1
6	C23-018-3100	Spring disc, 28 x 12.2 x 1.5 mm.....**	
	C23-018-3101	Spring disc, 28 x 12.2 x 1.0 mm.....**	
7	C23-023-1100	Plunger Assembly, 316 SST.....	1
	C23-023-1101	Plunger Assembly, SST, with tungsten carbide ball	1
	C23-023-1103	Plunger Assembly, 17-4 PH SST	1
	C23-023-1117	Plunger Assembly, Hastelloy C-276....	1
8	C23-013-2110	Seal, Back-up, Buna-N.....	1
	C23-013-2117	Seal, Back-up, UHMW polyethylene...	1
	C23-013-2118	Seal, Back-up, PTFE.....	1
9	C23-012-2110	Seal, Buna-N.....	1
	C23-012-2111	Seal, Viton	1
	C23-012-2113	Seal, EPDM.....	1
	C23-012-2115	Seal, Urethane	1
10*	C23-016-2110	O-ring, Sleeve, Buna-N.....	1
	C23-016-2111	O-ring, Sleeve, Viton.....	1
	C23-016-2113	O-ring, Sleeve, EPDM.....	1
11*	C23-024-1010	Sleeve, 316 SST.....	1
	C23-024-1017	Sleeve, Hastelloy C-276.....	1
12	C23-006-1000	Seat, 316 SST	1
	C23-006-1001	Seat, 17-4 HT	1
	C23-006-1002	Seat, Tungsten carbide	1
	C23-006-1017	Seat, Hastelloy C-276	1
13	C23-010-2110	O-ring, Valve seat, Buna-N.....	1
	C23-010-2111	O-ring, Valve seat, Viton	1
	C23-010-2113	O-ring, Valve seat, EPDM.....	1
14	C23-002-1006	Valve body, Brass, BSPT	1
15	C23-011-2110	O-ring, Buna-N.....	1
	C23-011-2111	O-ring, Viton.....	1
	C23-011-2113	O-ring, EPDM.....	1
-	C23-022-2403	Nameplate, C23, blank (specify model & serial no.)	1
-	A01-115-3400	Grease, Regulator valve spring, 1/4 ounce	

** See page 5 for spring disc quantities and arrangements.

C23D Parts



C23-DA, C23-DB, C23-DC

Stainless Steel Body Nickel Alloy Body

Ref. No.	Part Number	Description	Quantity/ Pump
1	C23-004-1005	Adjusting bolt, Pressure range A	1
	C23-004-1006	Adjusting bolt, Pressure range B	1
	C23-004-1007	Adjusting bolt, Pressure range C	1
2	C23-005-1000	Jam nut	1
3	G10-087-2010	Screw, Cap, M10 x 1.5 x 30 mm	4
4	G25-048-2010	Lockwasher, M10	4
5a	C23-003-1002	Valve top, Nonwetted	1
6	C23-018-3100	Spring disc, 28 x 12.2 x 1.5 mm	**
	C23-018-3101	Spring disc, 28 x 12.2 x 1.0 mm	**
7	C23-023-1100	Plunger Assembly, 316 SST	1
	C23-023-1101	Plunger Assembly, SST, with tungsten carbide ball	1
	C23-023-1103	Plunger Assembly, 17-4 PH SST	1
7	C23-023-1117	Plunger Assembly, Hastelloy C-276	1
8	C23-013-2110	Seal, Back-up, Buna-N	1
	C23-013-2117	Seal, Back-up, UHMW polyethylene	1
	C23-013-2118	Seal, Back-up, PTFE	1
9	C23-012-2110	Seal, Buna-N	1
	C23-012-2111	Seal, Viton	1
	C23-012-2113	Seal, EPDM	1
	C23-012-2115	Seal, Urethane	1
10*	C23-011-2110	O-ring, Sleeve, Buna-N	1
	C23-011-2111	O-ring, Sleeve, Viton	1
	C23-011-2113	O-ring, Sleeve, EPDM	1
11*	C23-024-1010	Sleeve, 316 SST	1
	C23-024-1017	Sleeve, Hastelloy C-276	1
12	C23-006-1000	Seat, 316 SST	1
	C23-006-1001	Seat, 17-4 HT	1
	C23-006-1002	Seat, Tungsten carbide	1
	C23-006-1017	Seat, Hastelloy C-276	1
13	C23-010-2110	O-ring, Valve seat, Buna-N	1
	C23-010-2111	O-ring, Valve seat, Viton	1
	C23-010-2113	O-ring, Valve seat, EPDM	1
14	C23-002-1004	Valve body, 316 SST, BSPT	1
	C23-002-1018	Valve body, Nickel alloy C series, BSPT	1
15	C23-011-2110	O-ring, Buna-N	1
	C23-011-2111	O-ring, Viton	1
	C23-011-2113	O-ring, EPDM	1
-	C23-022-2403	Nameplate, C23, blank (specify model & serial no.)	1
-	A01-115-3400	Grease, Regulator valve spring, 1/4 ounce	

** See page 5 for spring disc quantities and arrangements.

C23-DE

Brass Body Stainless Steel Body Nickel Alloy Body

Ref. No.	Part Number	Description	Quantity/ Pump
1	C23-004-1008	Adjusting bolt, Pressure range E	1
2	C23-005-1000	Jam nut	1
3	G03-068-2010	Screw, Cap, M10 x 1.5 x 40 mm	4
4	G25-048-2010	Lockwasher, M10	4
5c	C23-003-1003	Valve top, Brass, 172 bar	1
6	C23-018-3100	Spring disc, 28 x 12.2 x 1.5 mm	28
7	C23-023-1100	Plunger Assembly, 316 SST	1
	C23-023-1103	Plunger Assembly, 17-4 PH SST	1
	C23-023-1117	Plunger Assembly, Hastelloy C-276	1
8	C23-013-2110	Seal, Back-up, Buna-N	1
	C23-013-2118	Seal, Back-up, PTFE	1
9	C23-012-2110	Seal, Buna-N	1
	C23-012-2111	Seal, Viton	1
10*	C23-016-2110	O-ring, Sleeve, Buna-N	1
	C23-016-2111	O-ring, Sleeve, Viton	1
11*	C23-024-1010	Sleeve, 316 SST	1
	C23-024-1017	Sleeve, Hastelloy C-276	1
12	C23-006-1000	Seat, 316 SST	1
	C23-006-1001	Seat, 17-4 HT	1
	C23-006-1017	Seat, Hastelloy C-276	1
13	C23-010-2110	O-ring, Valve seat, Buna-N	1
	C23-010-2111	O-ring, Valve seat, Viton	1
14	C23-002-1006	Valve body, Brass, BSPT	1
	C23-002-1004	Valve body, 316 SST, BSPT	1
	C23-002-1018	Valve body, Nickel alloy C series, BSPT	1
15	C23-011-2110	O-ring, Buna-N	1
	C23-011-2111	O-ring, Viton	1
-	C23-022-2403	Nameplate, C23, blank (specify model & serial no.)	1
-	A01-115-3400	Grease, Regulator valve spring, 1/4 ounce	



C24D Parts



C24-DA, C24-DB, and C24-DC

Brass Body Stainless Steel Body Nickel Alloy Body

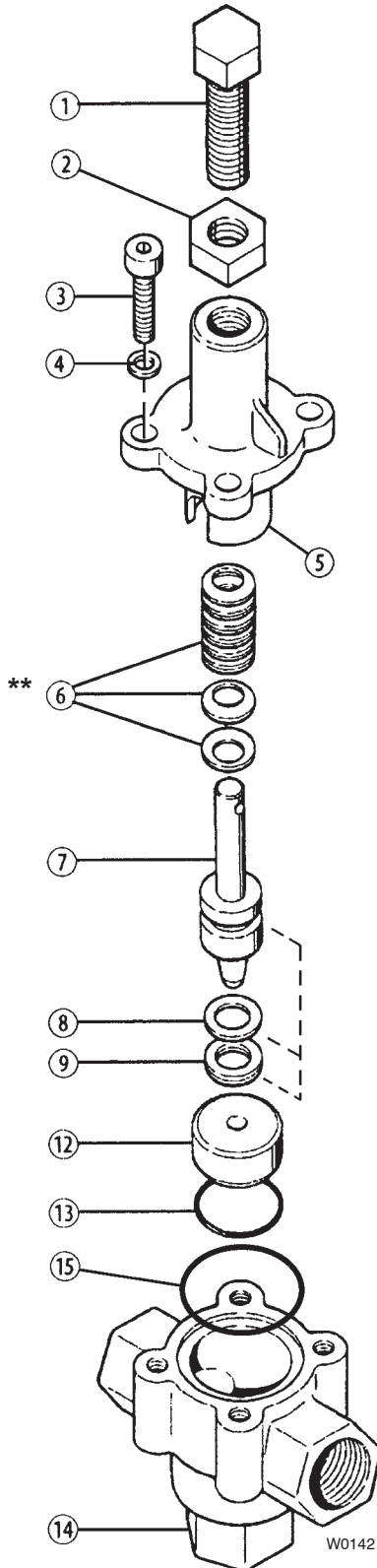

Ref. No.	Part Number	Description	Quantity/ Pump
1	C24-004-1005	Adjusting bolt, Pressure range A	1
	C24-004-1006	Adjusting bolt, Pressure range B	1
	C24-004-1007	Adjusting bolt, Pressure range C	1
2	C24-005-1000	Jam nut.....	1
3	G35-081-2010	Screw, Cap, M12 x 1.75 x 40 mm.....	4
4	G35-084-2010	Lockwasher, M12	4
5	C24-003-1000	Valve top, Brass	1
	C24-003-1001	Valve top, 316 SST	1
	C24-003-1002	Valve top, Nickel alloy C series	1
6	C24-018-3100	Spring disc, 35.5 x 18.3 x 2.0 mm.....**	**
	C24-018-3102	Spring disc, 35.5 x 18.3 x 1.2 mm.....**	**
7	C24-023-1100	Plunger Assembly, 316 SST.....	1
	C24-023-1101	Plunger Assembly, SST, with tungsten carbide ball	1
	C24-023-1102	Plunger Assembly, Hastelloy C-276....	1
	C24-023-1103	Plunger Assembly, 17-4 PH SST	1
8	C24-013-2110	Seal, Back-up, Buna-N.....	1
	C24-013-2118	Seal, Back-up, Viton.....	1
9	C24-012-2110	Seal, Buna-N.....	1
	C24-012-2111	Seal, Viton,	1
	C24-012-2113	Seal, EPDM.....	1
12	C24-006-1000	Seat, 316 SST	1
	C24-006-1001	Seat, 17-4 HT	1
	C24-006-1002	Seat, Tungsten carbide	1
	C24-006-1003	Seat, Hastelloy C-276	1
13	C23-010-2110	O-ring, Valve seat, Buna-N.....	1
	C23-010-2111	O-ring, Valve seat, Viton.....	1
	C23-010-2113	O-ring, Valve seat, EPDM.....	1
14	C24-002-1006	Valve body, Brass, BSPT	1
	C24-002-1007	Valve body, 316 SST, BSPT	1
	C24-002-1008	Valve body, Nickel alloy C series, BSPT.....	1
15	C24-011-2110	O-ring, Buna-N.....	1
	C24-011-2111	O-ring, Viton	1
	C24-011-2113	O-ring, EPDM.....	1
-	C24-022-2401	Nameplate, C24, blank (specify model & serial no.)	1
-	A01-115-3400	Grease, Regulator valve spring, 1/4 ounce.....	1

** See page 5 for spring disc quantities and arrangements.

C22D/23D/24D Repair



The valve can generally be repaired in place, without removing it from the system.

When disassembling, note the number of spring discs and their arrangement. They must be reinstalled in the same arrangement (refer also to page 5 — note that they are stacked, either singly or in pairs, facing in alternate directions). When reassembling, apply liberal amounts of high-temperature regulator grease (Wanner #A01-115-3400) on the springs and around the plunger stem.

The seal (9) and back-up seal (8) must be replaced together; don't replace one without replacing the other.

C22D/23D/24D Troubleshooting

Excess Pressure Required to Bypass Fluid

- Regulating valve pressure not properly adjusted
- Not enough fluid being continuously bypassed
- Nozzles worn

Fluid Leaking from Hole in Valve Top

- Worn Seals

System Losing Pressure

- Nozzles worn
- Pump RPM reduced
- Regulating valve pressure not properly adjusted
- Worn pump components
- Worn regulating valve seat or plunger
- System drawing in air
- Too much fluid being bypassed

Pressure Spikes

- Minimum bypass of 10% not being maintained
- Nozzles worn
- Regulating valve pressure not properly adjusted

Illinois Location:
 (847) 841-7867
 1675 Todd Farm Dr.
 Elgin, IL 60123

Minnesota Location:
 (651) 758-7867
 330 Mill Bay South Suite 1511
 Afton, MN 55001

PumpSupplyInc.com

 A map showing the outlines of Illinois and Minnesota. A star is placed in the western part of Illinois, and another star is placed in the eastern part of Minnesota. Below the map is the Pump Supply Incorporated logo, which consists of a blue triangle with 'PS' inside, followed by the text 'PUMP SUPPLY INCORPORATED'.

Warranty



Limited Warranty

Wanner Engineering, Inc. extends to the original purchaser of equipment manufactured by it and bearing its name, a limited one-year warranty from the date of purchase against defects in material or workmanship, provided that the equipment is installed and operated in accordance with the recommendations and instructions of Wanner Engineering, Inc. Wanner Engineering, Inc. will repair or replace, at its option, defective parts without charge if such parts are returned with transportation charges prepaid to Wanner Engineering, Inc., 1204 Chestnut Avenue, Minneapolis, Minnesota 55403.

This warranty does not cover:

1. The electric motors (if any), which are covered by the separate warranties of the manufacturers of these components.
2. Normal wear and/or damage caused by or related to abrasion, corrosion, abuse, negligence, accident, faulty installation or tampering in a manner which impairs normal operation.
3. Transportation costs.

This limited warranty is exclusive, and is in lieu of any other warranties (express or implied) including warranty of merchantability or warranty of fitness for a particular purpose and of any noncontractual liabilities including product liabilities based on negligence or strict liability. Every form of liability for direct, special, incidental or consequential damages or loss is expressly excluded and denied.

Illinois Location:

(847) 841-7867
1675 Todd Farm Dr.
Elgin, IL 60123

Minnesota Location:

(651) 758-7867
330 Mill Bay South Suite 1511
Afton, MN 55001

PumpSupplyInc.com

