

Installation & Service
C22-991-2400A

Hydra-Cell®

INDUSTRIAL VALVES

Models:
C22A, C23A, C24A

Bypass Pressure Regulating Valves
with NPT Threaded Ports

IMPORTANT

Record your pump model number and serial number here for easy reference:

Model No. _____

Serial No. _____

Date of Purchase _____

When ordering parts or making inquiries about this pump, please mention the model and serial numbers.

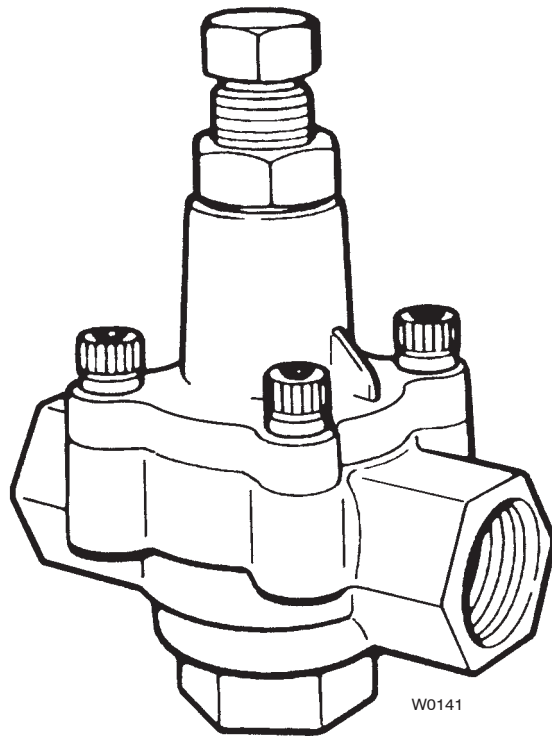

C22A/23A/24A Contents

	Page
Specifications.....	2
Installation.....	3
Disc Arrangement.....	5
C22A Parts.....	6
C23A Parts.....	8
C24A Parts.....	10
Repair & Troubleshooting.....	11
Warranty.....	12

C22A/23A/24A Specifications

Specifications

Capacity	Maximum		Minimum	
	gpm	l/min	gpm	l/min
C22	10	37.8	3	11.3
C23	20	75.7	3	11.3
C24	40	151.4	5	18.9

Pressure Range psi	Model Configuration			
	AA	AB	AC	AE
C22	75-500	500-1000	1000-1500	1500-2500
C23	75-500	500-1000	1000-1500	1500-2500
C24	75-500	500-1000	1000-1500	—

bar	Model Configuration			
	AA	AB	AC	AE
C22	5.3-34.5	34.5-69	69-103	103-172
C23	5.3-34.5	34.5-69	69-103	103-172
C24	5.3-34.5	34.5-69	69-103	—

Max Temperature: 200°F

Inlet and Outlet Ports:

C22	3/4" NPT
C23	1" NPT
C24	1-1/4" NPT

Dimensions: (H x W x D)

C22AA, AB, AC	6.0 x 3.4 x 2.2 in. (152.4 x 86.4 x 55.9 mm)
C22AE	6.4 x 3.4 x 2.2 in. (163.6 x 86.4 x 55.9 mm)
C23AA, AB, AC	7.0 x 4.8 x 2.8 in. (178 x 122 x 71.1 mm)
C23AE	7.4 x 4.8 x 2.8 in. (188 x 122 x 71.1 mm)
C24AA, AB, AC	9.0 x 5.4 x 3.3 in. (229 x 137.2 x 83.8 mm)

Weight

C22	3 lbs (1.3 kg)
C23	6 lbs (2.7 kg)
C24	10 lbs (4.5 kg)



C22A/23A/24A Installation

Location

The Bypass Pressure Regulating Valve prevents system pressure from exceeding a preset maximum. As the system approaches this maximum pressure, excess fluid is bypassed (to a supply tank, or to the pump inlet). This prevents overpressurization and system failures.

Install the regulating valve between the pump outlet (as close to the pump as possible) and any shut-off device in the discharge plumbing. It may be located **in** the discharge line, or **off**-line:

- If in-line, use either of the horizontal ports as the inlet and the other as the outlet;
- If off-line, use either of the horizontal ports as the inlet and plug the other one.

The **bottom** port is always the bypass port.

Mounting Position

The preferred mounting position is vertical with the adjusting bolt at the top.

Connections

For best operation, the bypass line should return to the supply tank. If you must plumb the bypass line back to the pump inlet instead, have it enter the inlet line as far from the pump as possible. Contact the pump manufacturer, as a pressure regulator may be required in the pump inlet.

The bypass line should be as large as the ports of the regulating valve. Do **not** install shutoff valves or other restrictions.

Install a high-quality industrial pressure gauge in the discharge system to monitor system pressure. Failure to do so may result in overpressurization and premature failure of pumping system components.

For smoothest operation and minimal pressure spiking when the discharge system is closed (closed gun, plugged nozzles, valve closed), about 10% of the rated flow of the regulating valve should be bypassed at all times.

Example: With the C22A valve (rated at 10 gpm), 1 gpm should be bypassing at all times during operation. If the desired spray gun delivery is 6 gpm, then the pump should deliver 7 gpm (6 gpm to the gun and 1 gpm to be bypassed). The nozzle orifices should be properly sized for 6 gpm delivery at the desired pressure; the pump RPM for 7 gpm; and the pump HP for 7 gpm at the bypass pressure (bypass pressure is higher than nozzle pressure).

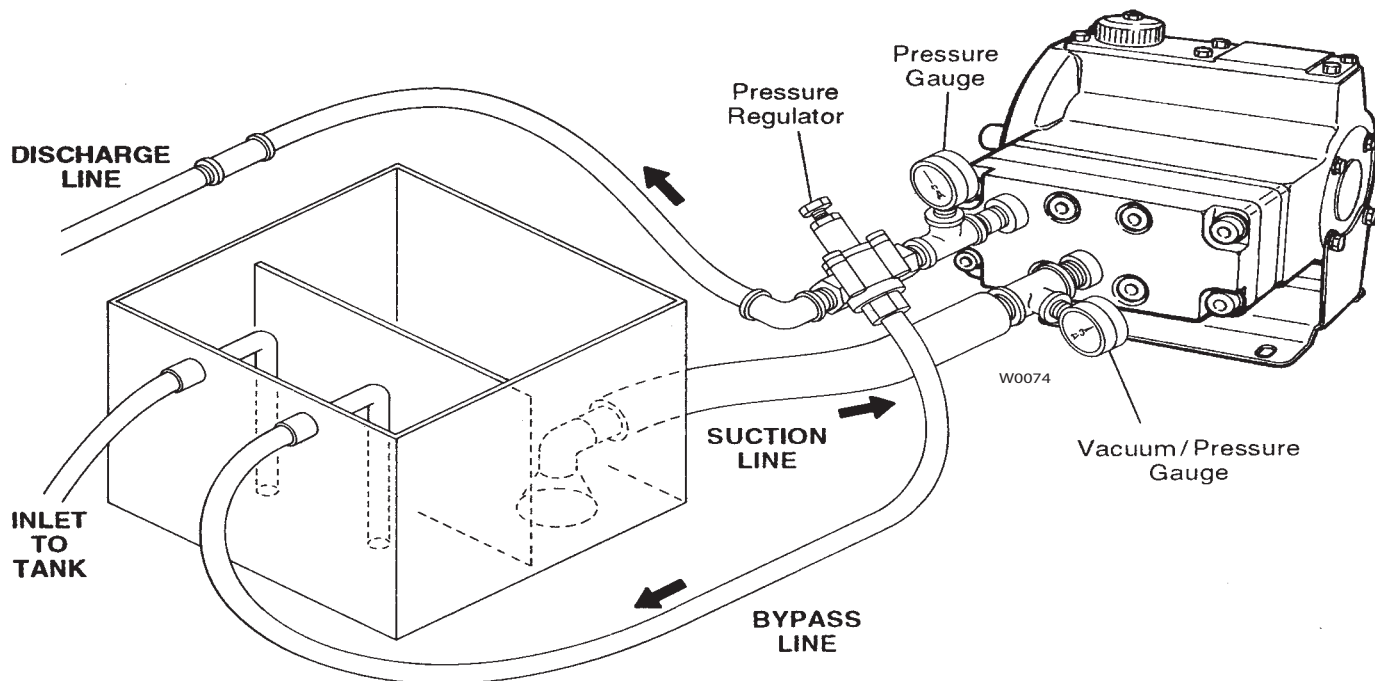

C22A/23A/24A Installation

Pressure Adjustment

Systems with Shutoff Guns or Valves

1. Turn off the system.
2. Turn the adjusting nut counterclockwise until there is no longer any pressure on the springs in the regulating valve.
3. Close the discharge line.
4. Be sure the piping and all valves and nozzles are open.
With an accurate pressure gauge installed in the system, start the system and let it run for a few minutes to remove any air.
5. When all air has been removed, begin turning the adjusting nut clockwise until the desired bypass pressure is reached.
Do not exceed the maximum rated pressure of the pump or the regulating valve!
6. Open and close the discharge line 3 or 4 times. Re-check the bypass pressure each time, and readjust if necessary. Turn the adjusting nut clockwise to increase or counterclockwise to reduce the pressure.
7. Check that the fluid bypass is continuous and adequate. With guns or valves open, you should be bypassing about 10% of the rated flow of the regulating valve (see the Example above). If the system discharge pressure is less than desired when 10% of the flow is bypassing, check the pump speed and delivery and the size of the nozzle or system orifice.
8. When both the bypass pressure and the flow have been set, turn the locknut clockwise to lock in the adjustment.

Systems without Shutoff Guns or Valves

Note: When making this adjustment, you must be able to observe the amount of fluid being bypassed.

1. Turn off the system.
2. Turn the adjusting nut counterclockwise until there is no longer any pressure on the springs in the regulating valve.
3. With an accurate pressure gauge installed in the system start the system and let it run for a few minutes to remove any air. The full flow of the pump should be bypassing.
4. Be sure all nozzles are open.
5. When all air has been removed, begin turning the adjusting nut clockwise until the desired bypass pressure is reached, or until no fluid is being bypassed — whichever occurs first.
Do not exceed the maximum rated pressure of the pump or the regulating valve!
6. If the system discharge pressure is less than desired, check the pump speed and delivery and the size of the nozzle or system orifice.
7. When both the bypass pressure and the flow have been set, turn the locknut clockwise to lock in the adjustment.



C22A

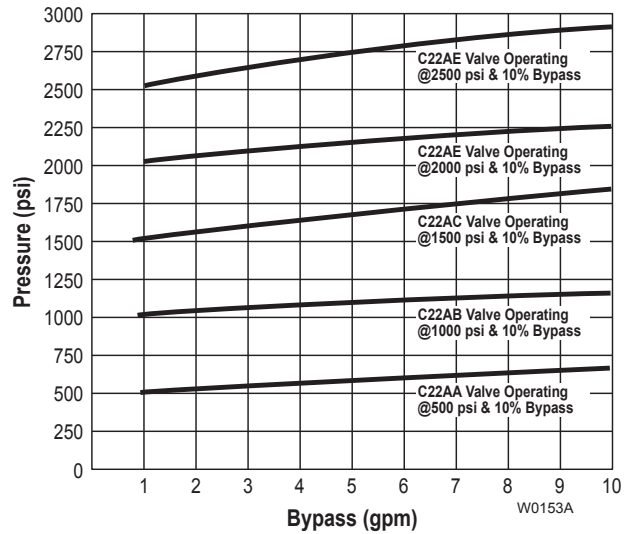

C23A

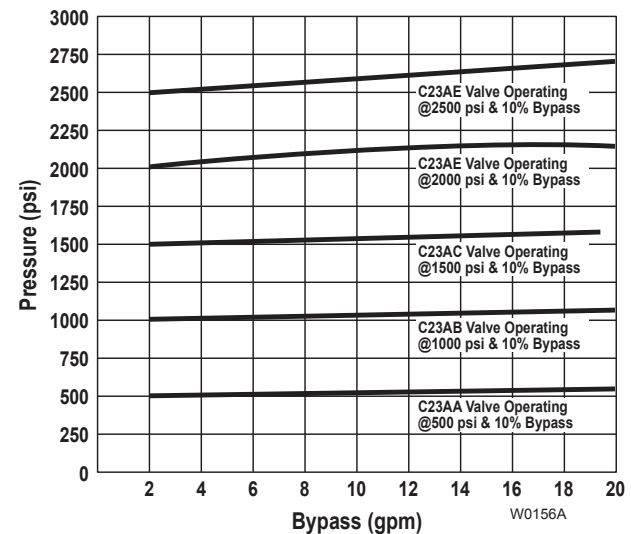

C24A

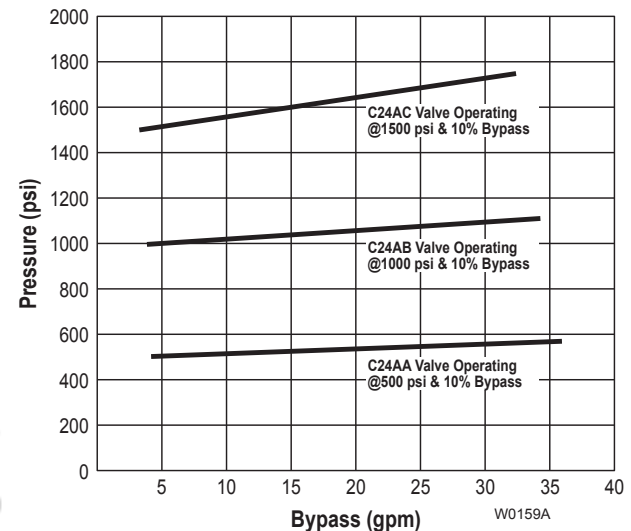

C22A/23A/24A Spring Disc Arrangement

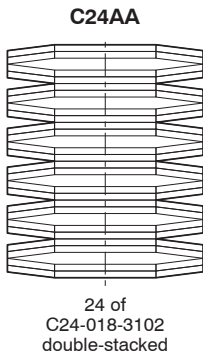
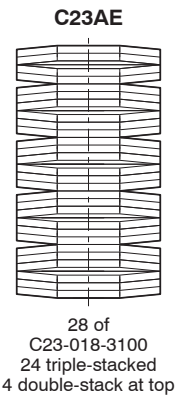
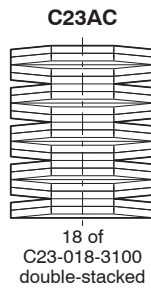
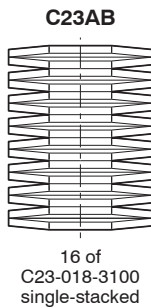
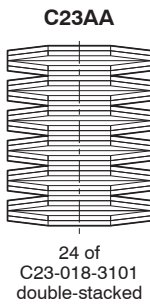
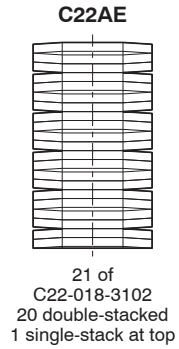
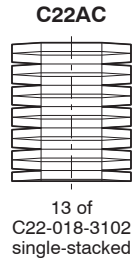
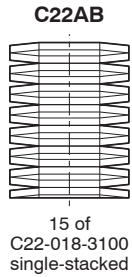
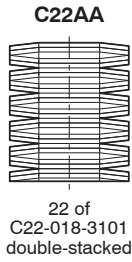

W0161

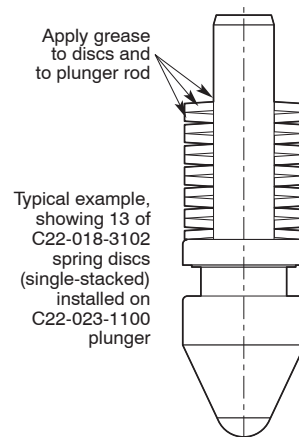
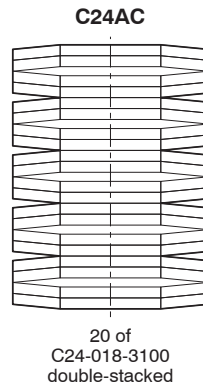
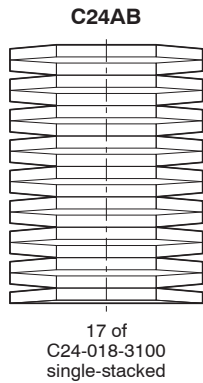

Spring Disc Size and Arrangement

Valve Model	gpm	psi	Disc Size OD x ID x Thickness	Quantity Used
C22AA	3-10	75-500	20 x 10.2 x 0.8 mm	22 (double stack)
C22AB	3-10	500-1000	20 x 10.2 x 1.2 mm	15 (single stack)
C22AC	3-10	1000-1500	20 x 10.2 x 1.5 mm	13 (single stack)
C22AE	3-10	1500-2500	20 x 10.2 x 1.5 mm	1 (single stack); 20 (double stack)
C23AA	3-20	75-500	28 x 12.2 x 1.0 mm	24 (double stack)
C23AB	3-20	500-1000	28 x 12.2 x 1.5 mm	16 (single stack)
C23AC	3-20	1000-1500	28 x 12.2 x 1.5 mm	18 (double stack)
C23AE	3-20	1500-2500	28 x 12.2 x 1.5 mm	4 (double stack); 24 (triple stack)
C24AA	5-40	75-500	35.5 x 18.3 x 1.2 mm	24 (double stack)
C24AB	5-40	500-1000	35.5 x 18.3 x 2.0 mm	17 (single stack)
C24AC	5-40	1000-1500	35.5 x 18.3 x 2.0 mm	20 (double stack)

C22A Parts

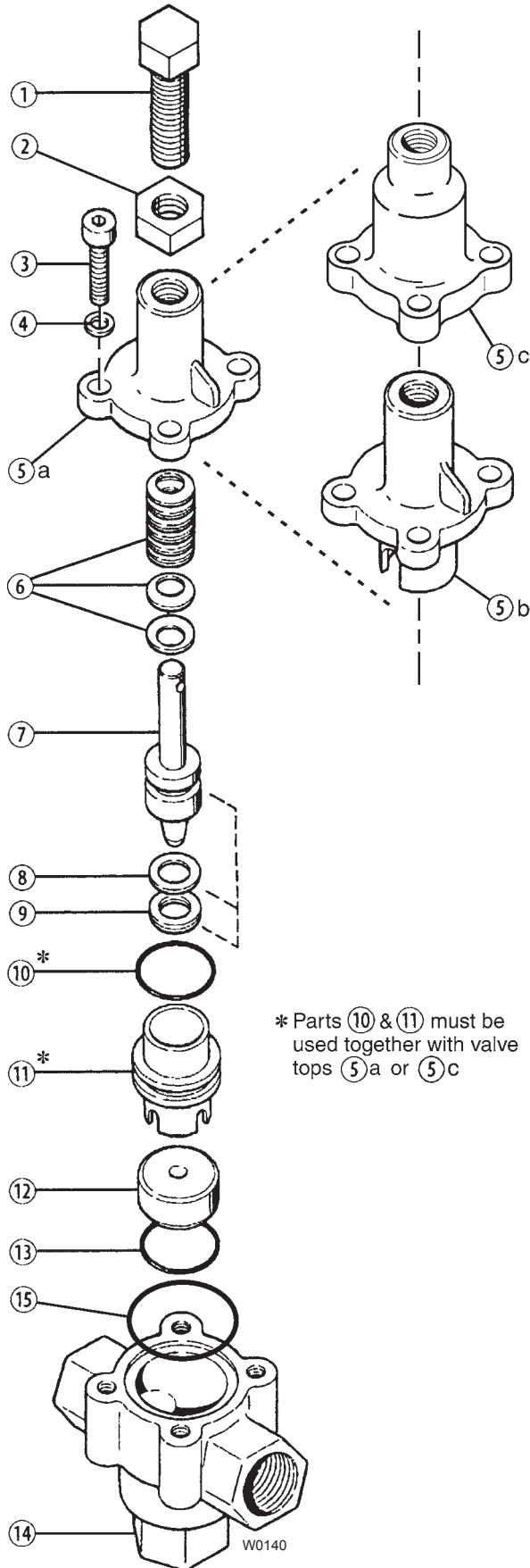

* Parts ⑩ & ⑪ must be used together with valve tops ⑤a or ⑤c

C22AA, C22AB, and C22AC

Brass Body

Ref. No.	Part Number	Description	Quantity/Pump
1	C22-004-1005	Adjusting bolt, Pressure range A	1
	C22-004-1006	Adjusting bolt, Pressure range B, C....	1
2	C22-005-1000	Jam nut.....	1
3	C22-015-2000	Screw, Cap, 5/16 x 1"	4
4	C22-014-2000	Lockwasher, 5/16"	4
5a	C22-003-1002	Valve top, Unwetted	1
5b	C22-003-1000	Valve top, Brass	1
6	C22-018-3100	Spring disc, 20 x 10.2 x 1.2 mm.....**	**
	C22-018-3101	Spring disc, 20 x 10.2 x 0.8 mm.....**	**
	C22-018-3102	Spring disc, 20 x 10.2 x 1.5 mm.....**	**
7	C22-023-1100	Plunger Assembly, 316 SST.....	1
	C22-023-1101	Plunger Assembly, SST, with tungsten carbide ball	1
	C22-023-1103	Plunger Assembly, 17-4 PH SST	1
	C22-023-1117	Plunger Assembly, Hastelloy C-276....	1
8	C22-013-2110	Seal, Back-up, Buna-N.....	1
	C22-013-2117	Seal, Back-up, UHMW polyethylene...	1
	C22-013-2118	Seal, Back-up, PTFE.....	1
9	C22-012-2110	Seal, Buna-N.....	1
	C22-012-2111	Seal, Viton	1
	C22-012-2113	Seal, EPDM.....	1
	C22-012-2115	Seal, Urethane	1
10*	C22-016-2110	O-ring, Sleeve, Buna-N.....	1
	C22-016-2111	O-ring, Sleeve, Viton.....	1
	C22-016-2113	O-ring, Sleeve, EPDM.....	1
11*	C22-024-1010	Sleeve, 316 SST.....	1
	C22-024-1017	Sleeve, Hastelloy C-276.....	1
12	C22-006-1000	Seat, 316 SST	1
	C22-006-1001	Seat, 17-4 HT	1
	C22-006-1002	Seat, Tungsten carbide	1
	C22-006-1017	Seat, Hastelloy C-276	1
13	C22-010-2110	O-ring, Valve seat, Buna-N.....	1
	C22-010-2111	O-ring, Valve seat, Viton.....	1
	C22-010-2113	O-ring, Valve seat, EPDM.....	1
14	C22-002-1000	Valve body, Brass, NPT	1
15	C22-011-2110	O-ring, Buna-N.....	1
	C22-011-2111	O-ring, Viton	1
	C22-011-2113	O-ring, EPDM.....	1
-	C22-022-2402	Nameplate, C22, blank (specify model & serial no.)	1
-	A01-115-3400	Grease, Regulator valve spring, 1/4 ounce.....	1

** See page 5 for spring disc quantities and arrangements.



C22A Parts



C22AA, C22AB, and C22AC

Stainless Steel Body Nickel Alloy Body

Ref. No.	Part Number	Description	Quantity/ Pump
1	C22-004-1005	Adjusting bolt, Pressure range A	1
	C22-004-1006	Adjusting bolt, Pressure range B, C	1
2	C22-005-1000	Jam nut	1
3	C22-015-2000	Screw, Cap, 5/16 x 1"	4
4	C22-014-2000	Lockwasher, 5/16"	4
5a	C22-003-1002	Valve top, Nonwetted	1
6	C22-018-3100	Spring disc, 20 x 10.2 x 1.2 mm	**
	C22-018-3101	Spring disc, 20 x 10.2 x 0.8 mm	**
	C22-018-3102	Spring disc, 20 x 10.2 x 1.5 mm	**
7	C22-023-1100	Plunger Assembly, 316 SST	1
	C22-023-1101	Plunger Assembly, SST, with tungsten carbide ball	1
	C22-023-1103	Plunger Assembly, 17-4 PH SST	1
	C22-023-1117	Plunger Assembly, Hastelloy C-276	1
8	C22-013-2110	Seal, Back-up, Buna-N	1
	C22-013-2117	Seal, Back-up, UHMW polyethylene	1
	C22-013-2118	Seal, Back-up, PTFE	1
9	C22-012-2110	Seal, Buna-N	1
	C22-012-2111	Seal, Viton	1
	C22-012-2113	Seal, EPDM	1
	C22-012-2115	Seal, Urethane	1
10*	C22-016-2110	O-ring, Sleeve, Buna-N	1
	C22-016-2111	O-ring, Sleeve, Viton	1
	C22-016-2113	O-ring, Sleeve, EPDM	1
11*	C22-024-1010	Sleeve, 316 SST	1
	C22-024-1017	Sleeve, Hastelloy C-276	1
12	C22-006-1000	Seat, 316 SST	1
	C22-006-1001	Seat, 17-4 HT	1
	C22-006-1002	Seat, Tungsten carbide	1
	C22-006-1017	Seat, Hastelloy C-276	1
13	C22-010-2110	O-ring, Valve seat, Buna-N	1
	C22-010-2111	O-ring, Valve seat, Viton	1
	C22-010-2113	O-ring, Valve seat, EPDM	1
14	C22-002-1002	Valve body, 316 SST, NPT	1
	C22-002-1017	Valve body, Nickel alloy C series NPT	1
15	C22-011-2110	O-ring, Buna-N	1
	C22-011-2111	O-ring, Viton	1
	C22-011-2113	O-ring, EPDM	1
-	C22-022-2402	Nameplate, C22, blank (specify model & serial no.)	1
-	A01-115-3400	Grease, Regulator valve spring, 1/4 ounce	

** See page 5 for spring disc quantities and arrangements.

C22AE

Brass Body Stainless Steel Body Nickel Alloy Body

Ref. No.	Part Number	Description	Quantity/ Pump
1	C22-004-1008	Adjusting bolt, Pressure range E	1
2	C22-005-1000	Jam nut	1
3	C22-015-2010	Screw, Cap, 5/16 x 1-1/4"	4
4	C22-014-2000	Lockwasher, 5/16"	4
5c	C22-003-1003	Valve top, Non-wetted, 2500 psi	1
6	C22-018-3102	Spring disc, 20 x 10.2 x 1.5 mm	21
7	C22-023-1000	Plunger Assembly, 316 SST	1
	C22-023-1003	Plunger Assembly, 17-4 PH SST	1
	C22-023-1007	Plunger Assembly, Hastelloy C-276	1
8	C22-013-2110	Seal, Back-up, Buna-N	1
	C22-013-2117	Seal, Back-up, UHMW polyethylene	1
	C22-013-2118	Seal, Back-up, PTFE	1
9	C22-012-2110	Seal, Buna-N	1
	C22-012-2111	Seal, Viton	1
	C22-012-2115	Seal, Urethane	1
10*	C22-016-2110	O-ring, Sleeve, Buna-N	1
	C22-016-2111	O-ring, Sleeve, Viton	1
11*	C22-024-1010	Sleeve, 316 SST	1
	C22-024-1017	Sleeve, Hastelloy C-276	1
12	C22-006-1000	Seat, 316 SST	1
	C22-006-1001	Seat, 17-4 HT	1
	C22-006-1017	Seat, Hastelloy C-276	1
13	C22-010-2110	O-ring, Valve seat, Buna-N	1
	C22-010-2111	O-ring, Valve seat, Viton	1
14	C22-002-1000	Valve body, Brass, NPT	1
	C22-002-1002	Valve body, 316 SST, NPT	1
	C22-002-1017	Valve body, Nickel alloy C series NPT	1
15	C22-011-2110	O-ring, Buna-N	1
	C22-011-2111	O-ring, Viton	1
-	C22-022-2402	Nameplate, C22, blank (specify model & serial no.)	1
-	A01-115-3400	Grease, Regulator valve spring, 1/4 ounce	



C23A Parts

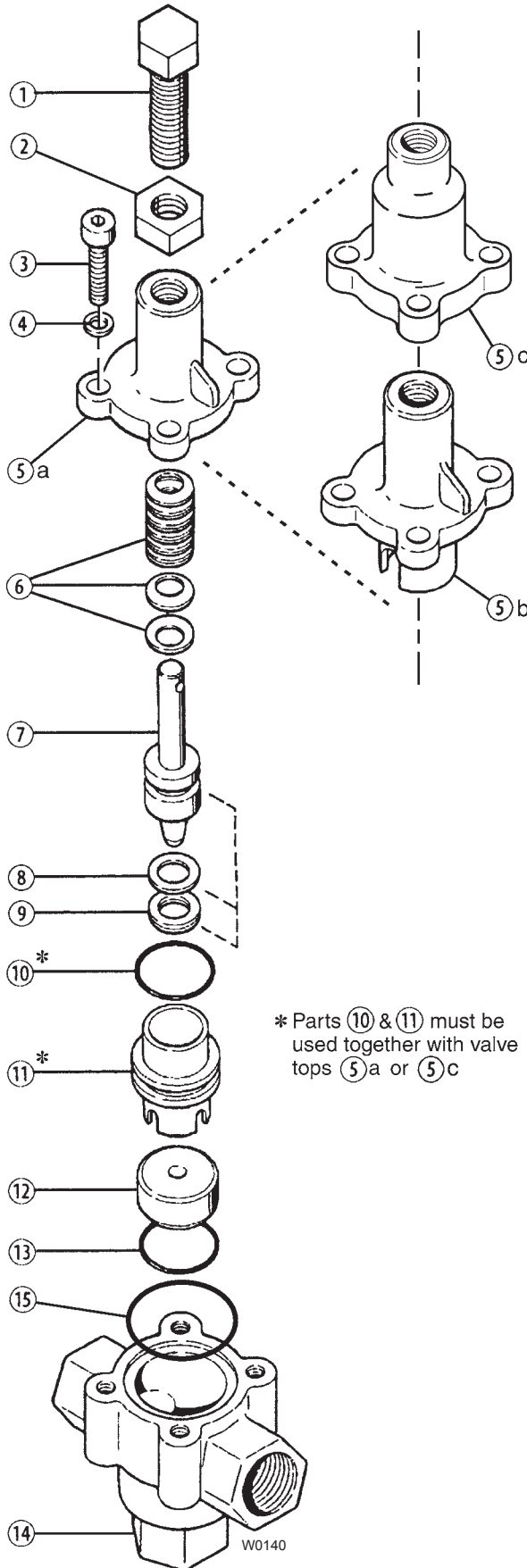

* Parts ⑩ & ⑪ must be used together with valve tops ⑤a or ⑤c

C23AA, C23AB, and C23AC

Brass Body

Ref. No.	Part Number	Description	Quantity/ Pump
1	C23-004-1005	Adjusting bolt, Pressure range A	1
	C23-004-1006	Adjusting bolt, Pressure range B	1
	C23-004-1007	Adjusting bolt, Pressure range C	1
2	C23-005-1000	Jam nut.....	1
3	D25-029-2010	Screw, Cap, 3/8 x 1-1/4"	4
4	D10-048-2010	Lockwasher, 3/8"	4
5a	C23-003-1002	Valve top, Nonwetted	1
5b	C23-003-1000	Valve top, Brass	1
6	C23-018-3100	Spring disc, 28 x 12.2 x 1.5 mm	**
	C23-018-3101	Spring disc, 28 x 12.2 x 1.0 mm	**
7	C23-023-1100	Plunger Assembly, 316 SST.....	1
	C23-023-1101	Plunger Assembly, SST, with tungsten carbide ball	1
	C23-023-1103	Plunger Assembly, 17-4 PH SST	1
	C23-023-1117	Plunger Assembly, Hastelloy C-276....	1
8	C23-013-2110	Seal, Back-up, Buna-N.....	1
	C23-013-2117	Seal, Back-up, UHMW polyethylene...	1
	C23-013-2118	Seal, Back-up, PTFE.....	1
9	C23-012-2110	Seal, Buna-N.....	1
	C23-012-2111	Seal, Viton	1
	C23-012-2113	Seal, EPDM.....	1
	C23-012-2115	Seal, Urethane	1
10*	C23-016-2110	O-ring, Sleeve, Buna-N.....	1
	C23-016-2111	O-ring, Sleeve, Viton.....	1
	C23-016-2113	O-ring, Sleeve, EPDM.....	1
11*	C23-024-1010	Sleeve, 316 SST.....	1
	C23-024-1017	Sleeve, Hastelloy C-276.....	1
12	C23-006-1000	Seat, 316 SST	1
	C23-006-1001	Seat, 17-4 HT	1
	C23-006-1002	Seat, Tungsten carbide	1
	C23-006-1017	Seat, Hastelloy C-276	1
13	C23-010-2110	O-ring, Valve seat, Buna-N.....	1
	C23-010-2111	O-ring, Valve seat, Viton	1
	C23-010-2113	O-ring, Valve seat, EPDM.....	1
14	C23-002-1000	Valve body, Brass, NPT	1
15	C23-011-2110	O-ring, Buna-N.....	1
	C23-011-2111	O-ring, Viton	1
	C23-011-2113	O-ring, EPDM.....	1
-	C23-022-2403	Nameplate, C23, blank (specify model & serial no.)	1
-	A01-115-3400	Grease, Regulator valve spring, 1/4 ounce	

** See page 5 for spring disc quantities and arrangements.

C23A Parts



C23AA, C23AB, and C23AC

Stainless Steel Body Nickel Alloy Body

Ref. No.	Part Number	Description	Quantity/ Pump
1	C23-004-1005	Adjusting bolt, Pressure range A	1
	C23-004-1006	Adjusting bolt, Pressure range B	1
	C23-004-1007	Adjusting bolt, Pressure range C	1
2	C23-005-1000	Jam nut	1
3	D25-029-2010	Screw, Cap, 3/8" x 1-1/4"	4
4	D10-048-2010	Lockwasher	4
5a	C23-003-1002	Valve top, Nonwetted	1
6	C23-018-3100	Spring disc, 28 x 12.2 x 1.5 mm	**
	C23-018-3101	Spring disc, 28 x 12.2 x 1.0 mm	**
7	C23-023-1100	Plunger Assembly, 316 SST	1
	C23-023-1101	Plunger Assembly, SST, with tungsten carbide ball	1
	C23-023-1103	Plunger Assembly, 17-4 PH SST	1
	C23-023-1117	Plunger Assembly, Hastelloy C-276	1
8	C23-013-2110	Seal, Back-up, Buna-N	1
	C23-013-2117	Seal, Back-up, UHMW polyethylene	1
	C23-013-2118	Seal, Back-up, PTFE	1
9	C23-012-2110	Seal, Buna-N	1
	C23-012-2111	Seal, Viton	1
	C23-012-2113	Seal, EPDM	1
	C23-012-2115	Seal, Urethane	1
10*	C23-016-2110	O-ring, Sleeve, Buna-N	1
	C23-016-2111	O-ring, Sleeve, Viton	1
	C23-016-2113	O-ring, Sleeve, EPDM	1
11*	C23-024-1010	Sleeve, 316 SST	1
	C23-024-1017	Sleeve, Hastelloy C-276	1
12	C23-006-1000	Seat, 316 SST	1
	C23-006-1001	Seat, 17-4 HT	1
	C23-006-1002	Seat, Tungsten carbide	1
	C23-006-1017	Seat, Hastelloy C-276	1
13	C23-010-2110	O-ring, Valve seat, Buna-N	1
	C23-010-2111	O-ring, Valve seat, Viton	1
	C23-010-2113	O-ring, Valve seat, EPDM	1
14	C23-002-1002	Valve body, 316 SST, NPT	1
	C23-002-1017	Valve body, nickel alloy C series, NPT	1
15	C23-011-2110	O-ring, Buna-N	1
	C23-011-2111	O-ring, Viton	1
	C23-011-2113	O-ring, EPDM	1
-	C23-022-2403	Nameplate, C23, blank (specify model & serial no.)	1
-	A01-115-3400	Grease, Regulator valve spring, 1/4 ounce	

** See page 5 for spring disc quantities and arrangements.

C23AE

Brass Body Stainless Steel Body Nickel Alloy Body

Ref. No.	Part Number	Description	Quantity/ Pump
1	C23-004-1008	Adjusting bolt, Pressure range E	1
2	C23-005-1000	Jam nut	1
3	A04-041-2010	Screw, Cap, 3/8" x 1-1/2"	4
4	D10-048-2010	Lockwasher	4
5c	C23-003-1003	Valve top, Brass, 2500 psi	1
6	C23-018-3100	Spring disc, 28 x 12.2 x 1.5 mm	28
7	C23-023-1100	Plunger Assembly, 316 SST	1
	C23-023-1103	Plunger Assembly, 17-4 PH SST	1
	C23-023-1117	Plunger Assembly, Hastelloy C-276	1
8	C23-013-2110	Seal, Back-up, Buna-N	1
	C23-013-2118	Seal, Back-up, PTFE	1
9	C23-012-2110	Seal, Buna-N	1
	C23-012-2111	Seal, Viton	1
10*	C23-016-2110	O-ring, Sleeve, Buna-N	1
	C23-016-2111	O-ring, Sleeve, Viton	1
11*	C23-024-1010	Sleeve, 316 SST	1
	C23-024-1017	Sleeve, Hastelloy C-276	1
12	C23-006-1000	Seat, 316 SST	1
	C23-006-1001	Seat, 17-4 HT	1
	C23-006-1017	Seat, Hastelloy C-276	1
13	C23-010-2110	O-ring, Valve seat, Buna-N	1
	C23-010-2111	O-ring, Valve seat, Viton	1
14	C23-002-1000	Valve body, Brass, NPT	1
	C23-002-1002	Valve body, 316 SST, NPT	1
	C23-002-1017	Valve body, Nickel alloy C series, NPT	1
15	C23-011-2110	O-ring, Buna-N	1
	C23-011-2111	O-ring, Viton	1
-	C23-022-2403	Nameplate, C23, blank (specify model & serial no.)	1
-	A01-115-3400	Grease, Regulator valve spring, 1/4 ounce	





C24A Parts

C24AA, C24AB, and C24AC

Brass Body Stainless Steel Body Nickel Alloy Body

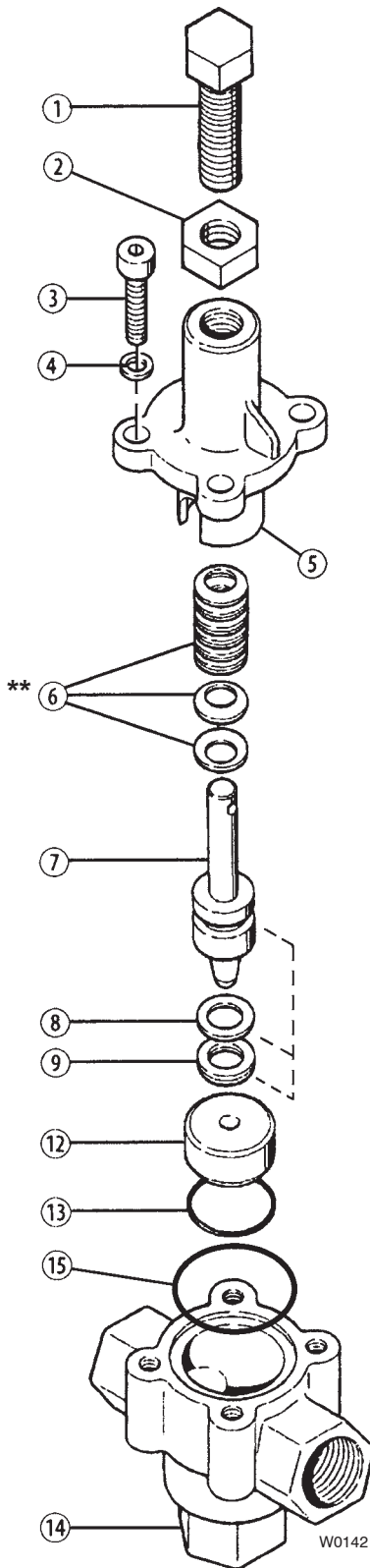

Ref. No.	Part Number	Description	Quantity/ Pump
1	C24-004-1005	Adjusting bolt, Pressure range A	1
	C24-004-1006	Adjusting bolt, Pressure range B	1
	C24-004-1007	Adjusting bolt, Pressure range C	1
2	C24-005-1000	Jam nut.....	1
3	C24-015-2000	Screw, Cap, 7/16 x 1-1/2"	4
		Lockwasher, 7/16"	
4	C24-014-2000	Lockwasher, 7/16"	4
		Valve top, Brass	
5	C24-003-1001	Valve top, 316 SST	1
		Valve top, Nickel alloy C series	
6	C24-018-3100	Spring disc, 35.5 x 18.3 x 2.0 mm.....	**
		Spring disc, 35.5 x 18.3 x 1.2 mm.....	
7	C24-023-1100	Plunger Assembly, 316 SST.....	1
		Plunger Assembly, SST, with tungsten carbide ball	
		Plunger Assembly, Hastelloy C-276....	
		Plunger Assembly, 17-4 PH SST	
8	C24-013-2110	Seal, Back-up, Buna-N.....	1
		Seal, Back-up, Viton.....	
9	C24-012-2110	Seal, Buna-N.....	1
		Seal, Viton,	
		Seal, EPDM.....	
12	C24-006-1000	Seat, 316 SST	1
		Seat, 17-4 HT	
		Seat, Tungsten carbide	
		Seat, Hastelloy C-276	
13	C23-010-2110	O-ring, Valve seat, Buna-N.....	1
		O-ring, Valve seat, Viton	
		O-ring, Valve seat, EPDM.....	
14	C24-002-1000	Valve body, Brass, NPT	1
		Valve body, 316 SST, NPT	
		Valve body, Nickel alloy C series, NPT	
15	C24-011-2110	O-ring, Buna-N.....	1
		O-ring, Viton.....	
		O-ring, EPDM.....	
-	C24-022-2401	Nameplate, C24, blank (specify model & serial no.)	1
-	A01-115-3400	Grease, Regulator valve spring, 1/4 ounce.....	

** See page 5 for spring disc quantities and arrangements.

C22A/23A/24A Repair



The valve can generally be repaired in place, without removing it from the system.

When disassembling, note the number of spring discs and their arrangement. They must be reinstalled in the same arrangement (refer also to page 5 — note that they are stacked, either singly or in pairs, facing in alternate directions). When reassembling, apply liberal amounts of high-temperature regulator grease (Wanner #A01-115-3400) on the springs and around the plunger stem.

The seal (9) and back-up seal (8) must be replaced together; don't replace one without replacing the other.

C22A/23A/24A Troubleshooting

Excess Pressure Required to Bypass Fluid

- Regulating valve pressure not properly adjusted
- Not enough fluid being continuously bypassed
- Nozzles worn

Pressure Spikes

- Minimum bypass of 10% not being maintained
- Nozzles worn
- Regulating valve pressure not properly adjusted

Fluid Leaking from Hole in Valve Top

- Worn Seals

System Losing Pressure

- Nozzles worn
- Pump RPM reduced
- Regulating valve pressure not properly adjusted
- Worn pump components
- Worn regulating valve seat or plunger
- System drawing in air
- Too much fluid being bypassed

Illinois Location:

(847) 841-7867
1675 Todd Farm Dr.
Elgin, IL 60123

Minnesota Location:

(651) 758-7867
330 Mill Bay South Suite 1511
Afton, MN 55001

PumpSupplyInc.com

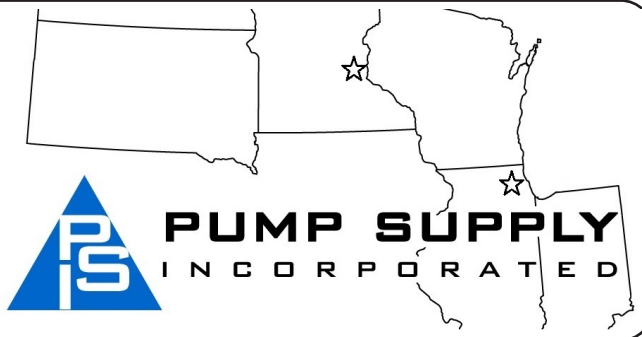

Warranty



Limited Warranty

Wanner Engineering, Inc. extends to the original purchaser of equipment manufactured by it and bearing its name, a limited one-year warranty from the date of purchase against defects in material or workmanship, provided that the equipment is installed and operated in accordance with the recommendations and instructions of Wanner Engineering, Inc. Wanner Engineering, Inc. will repair or replace, at its option, defective parts without charge if such parts are returned with transportation charges prepaid to Wanner Engineering, Inc., 1204 Chestnut Avenue, Minneapolis, Minnesota 55403.

This warranty does not cover:

1. The electric motors (if any), which are covered by the separate warranties of the manufacturers of these components.
2. Normal wear and/or damage caused by or related to abrasion, corrosion, abuse, negligence, accident, faulty installation or tampering in a manner which impairs normal operation.
3. Transportation costs.

This limited warranty is exclusive, and is in lieu of any other warranties (express or implied) including warranty of merchantability or warranty of fitness for a particular purpose and of any noncontractual liabilities including product liabilities based on negligence or strict liability. Every form of liability for direct, special, incidental or consequential damages or loss is expressly excluded and denied.

Illinois Location:

(847) 841-7867
1675 Todd Farm Dr.
Elgin, IL 60123

Minnesota Location:

(651) 758-7867
330 Mill Bay South Suite 1511
Afton, MN 55001

PumpSupplyInc.com

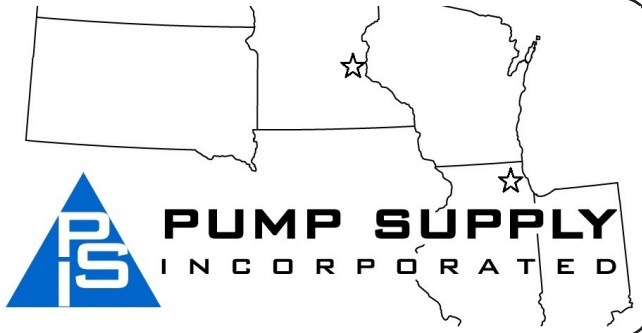

© 2004 Wanner Engineering, Inc. Printed in USA
C22-991-2400A 5/2004, Revised 3/2015