

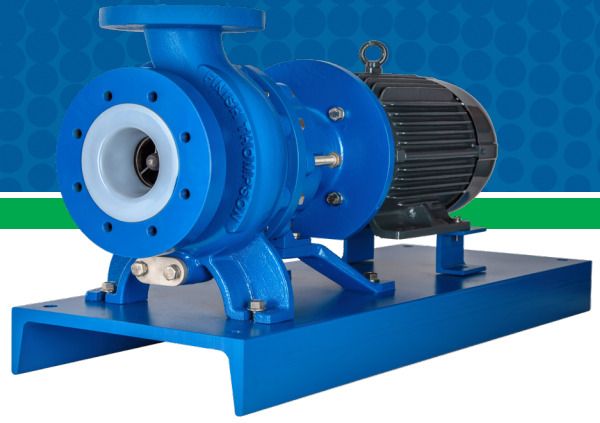

UCP SERIES

MODEL UCP436L (4X3X6)



UCP436L PERFORMANCE 3500 RPM, 60 Hz

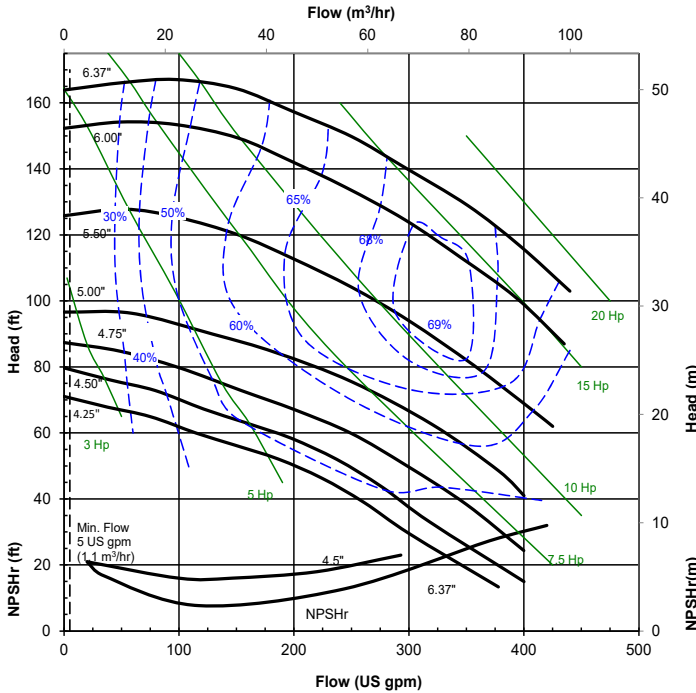

Impeller trims are available in 1/8" diameter increments (ex: 6.13", 4.37") between all curves
 Impeller trims are available in 1/8" diameter increments (ex: 6.13", 4.37") between all curves

UCP436L PERFORMANCE 2900 RPM, 50 Hz

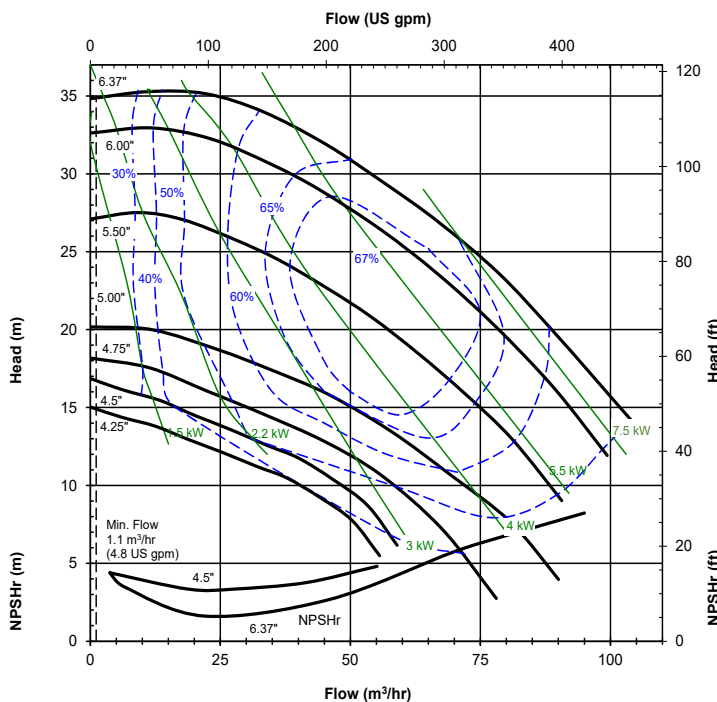

Impeller trims are available in 1/8" diameter increments (ex: 6.13", 4.37") between all curves

FEATURES

- UCP is designed to be a less expensive alternative to conventional ANSI dimensional mag drive pumps by combining a mixture of ETFE with polypropylene (PP) construction
- Durable, corrosion-resistant ETFE lined ductile iron casing
- Inner drive magnets are encapsulated in pure, unfilled polypropylene (PP) and 100% vacuum tested for guaranteed reliability and safety
- Impeller is glass-fiber reinforced polypropylene (PP)
- Barrier liner is glass-fiber reinforced polypropylene (PP) with a carbon fiber reinforced exterior for exceptional strength and chemical resistance against a wide variety of fluids
- Powerful neodymium magnets for dependable, leak-free operation
- Axial thrust is managed with an annular orifice and balance holes
- Dual impeller bushings greatly reduces shaft load
- Suction shaft support with integral straightening vanes
- Easy-set measurement free outer drive
- Space saving vertical operation with IEC motor
- Back pull-out design
- Exclusive vapor protection protects outer drive magnet and motor face from corrosive fumes
- Casing drain standard
- 1/2" NPT motor adapter port with stainless steel plug
- Accepts standard NEMA 143-286 or IEC 90-160 motor frames
- Maximum power 30HP/22kW
- ANSI 150, ANSI 300 or ISO PN40 flange mountable
- CE Certified



UCP SERIES

Item #	Description	Construction
1	Casing	Cast ductile iron, pure unfilled ETFE lined
2	Shaft support	Glass filled polypropylene (GF PP)
2A	Front thrust ring	Glass filled polypropylene (GF PP)
3	Impeller	Glass filled polypropylene (GF PP)
3A	Impeller thrust ring	Glass filled molybdenum disulfide-filled PTFE or alpha sintered silicon carbide
4	Inner drive	Neodymium iron boron magnets encapsulated in pure, unfilled polypropylene
4A	Bushing	Carbon, Alpha sintered silicon carbide, Dri-Coat (DLC) alpha sintered silicon carbide
4B	Bushing retaining ring	PTFE
5	Barrier	Molded glass filled polypropylene liner with carbon fiber reinforced exterior
5A	Barrier thrust ring	Alpha sintered silicon carbide
5B	Sealing ring	Glass filled molybdenum disulfide-filled PTFE
5C	Sealing ring retainer	Glass filled polypropylene (GF PP)
5D	Sealing ring lock	Glass filled polypropylene (GF PP)
6	Clamp ring	Powder coated ductile iron
7	Outer drive	Nickel plated neodymium iron boron magnets/ ductile iron
8	Motor adapter	Powder coated ductile iron
9	Shaft	High purity alumina ceramic, alpha sintered silicon carbide, Dri-Coat (DLC) alpha sintered silicon carbide
10	O-ring	FKM, EPDM, FEP-encapsulated FKM, Kalrez®, or Simriz®
11	Vapor Protection O-Rings	Buna N

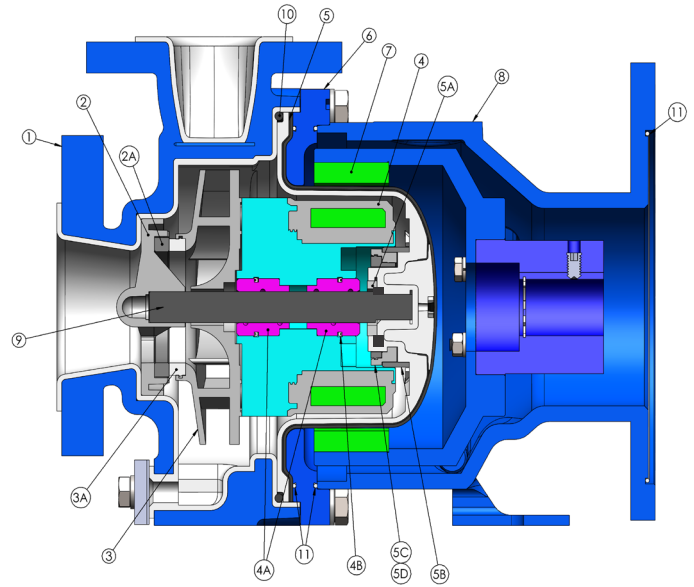

Kalrez® is a registered trademark of DuPont Performance Elastomers
 Simriz® Perfluoroelastomer is a registered trademark of Simrit® division of Freudenberg-NOK.
 Fluorosint® is a registered trademark of Quadrant DSM Engineering Plastic Products.

SPECIFICATIONS

HP (kW)	Impeller Diameter	Suction	Discharge	Max. Flow 3500 rpm		Max. Head 3500 rpm		Max. Working Pressure psi (Bar)	Max. Viscosity cP	Max. Specific Gravity	Max. Temp. °F (°C)
	in (cm)	in (cm)	in (cm)	gpm	m ³ /hr	ft.	m				
3 - 30 (1.1 - 22.0)	4 1/4 - 6 3/8 (10.8 - 16.2)	4 (10.2)	3 (7.6)	440	100	167	50.9	300 (21)	200	1.8	180 (82)

Note: Impeller trims available every 1/8" (.32 cm) between the smallest and largest diameters.

DIMENSIONS

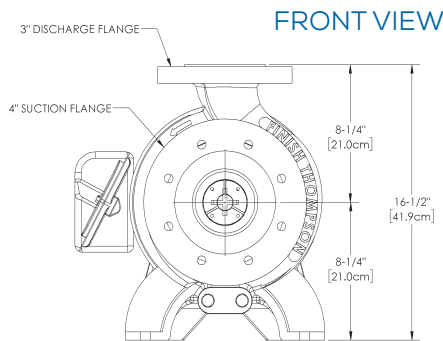

ANSI 150#, 300#, & ISO/DIN/PN40 flanges are in compliance with bolting dimensions only.

SIDE VIEW

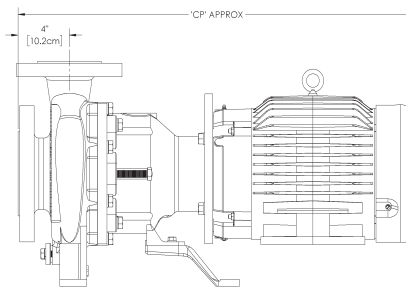

BOTTOM VIEW

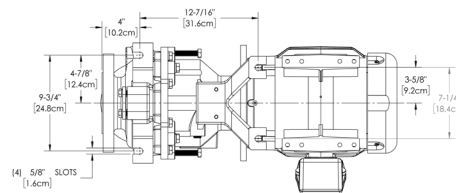

Motor Frames	CP (approx.)	
	(in)	(cm)
NEMA		
143-145TC	23-3/4	60
182/184TC	27-13/32	70
213/215TC	31-1/16	79
254/256TC	35-1/16	89
284/286TSC	38-13/32	98
IEC		
90 B14/B5	23-25/32	60
100/112 B14	25-7/32	64
100/112 B5	27-21/32	70
132 B5	31-5/16	80
160 B5	35-1/32	89



finishthompson.com

FINISH THOMPSON INC. - HEADQUARTERS

921 Greengarden Road | Erie, PA 16501
 800.934.9384 | ph 814.455.4478 | fx 814.455.8518
 email sales@finishthompson.com

FINISH THOMPSON INC. - EUROPE CENTER

Otto-Hahn-Strasse 16 | Maintal, D-63477 Germany
 49 (0)6181-90878-0 | fx 49 (0)6181-90878-18
 email europecenter@finishthompson.com