

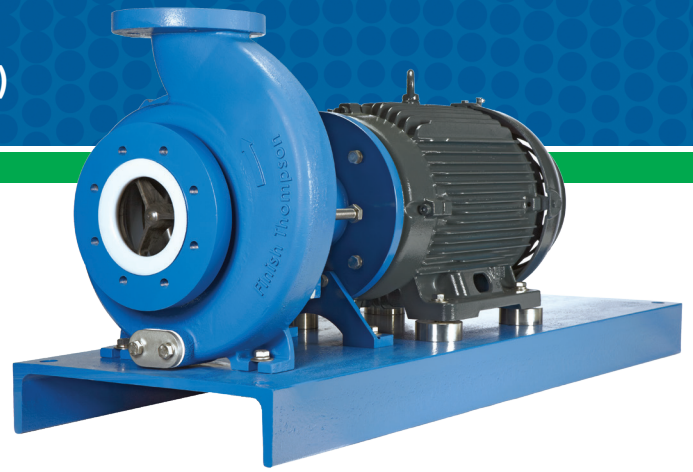

UCR SERIES

MODEL UCR4310H (4X3X10 - A70)



UCR4310H PERFORMANCE 1750 RPM, 60 Hz

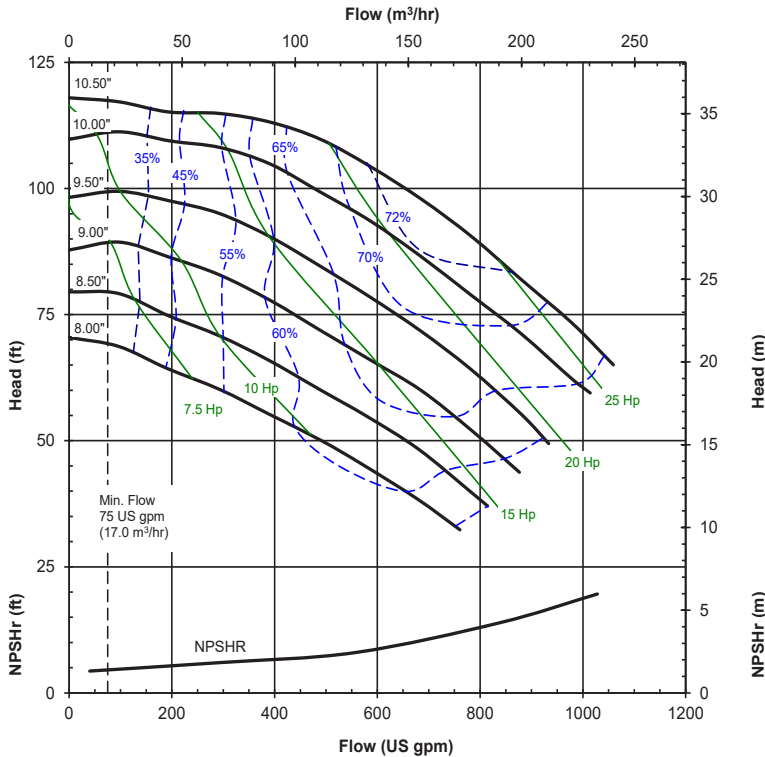

UCR4310H PERFORMANCE 1450 RPM, 50 Hz

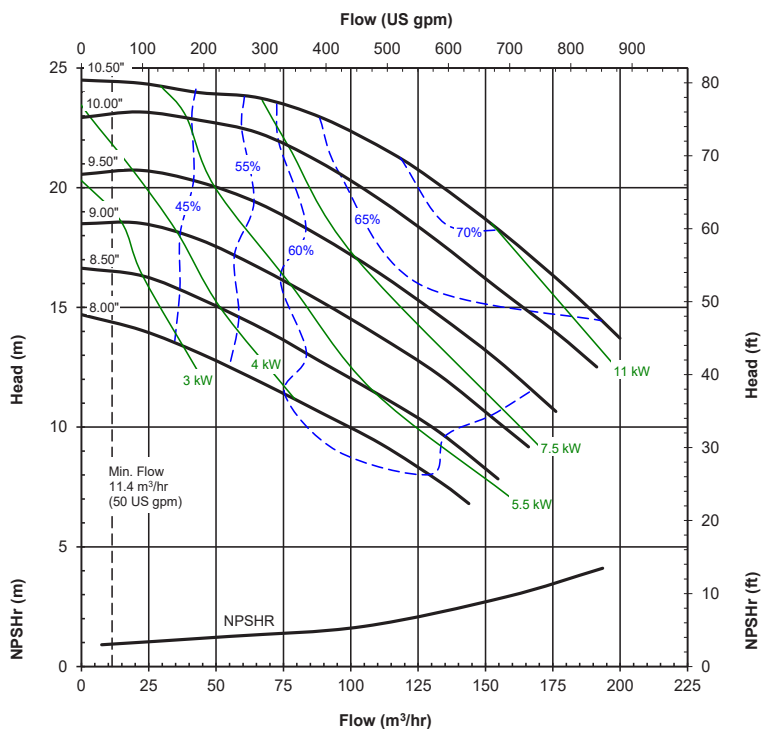

FEATURES

- Durable, corrosion-resistant ETFE lined ductile iron casing
- Inner drive magnets are encapsulated in pure, unfilled ETFE and are 100% vacuum tested for guaranteed reliability and safety
- Barrier liner is pure unfilled ETFE for maximum protection against chemical permeation with carbon fiber reinforced exterior for exceptional strength
- All critical containment components are pure, unfilled ETFE for the ultimate in corrosion resistance
- Casing meets ANSI/ASME B73.1m & B73.3 for foot and flange location
- Powerful neodymium magnets transmit maximum torque
- Interchangeable single piece impeller and drive magnet is securely interlocked, yet allows independent impeller or drive replacement
- Axial thrust is managed with an annular orifice and balance holes
- Dual impeller bushings greatly reduce shaft load
- Suction shaft support with integral straightening vanes
- Easy-set measurement free outer drive
- Space saving vertical installation option with IEC motor
- Back pull-out design
- Exclusive vapor protection protects drive magnet and motor face from corrosive fumes
- Run dry capability with carbon or Dri-Coat (DLC) SiC bushing
- Casing drain standard
- 1/2" NPT motor adapter port with stainless steel plug
- Specific gravity over 1.8
- Accepts standard NEMA 143-405 or IEC 90-280 motor frames
- Maximum power 50hp/37kW
- ANSI 150, ANSI 300 or ISO PN40 flange mountable
- CE Certified, ATEX certified models available



UCR SERIES

Item #	Description	Construction
1	Housing	Cast ductile iron, pure ETFE lined
2	Shaft support	Carbon fiber filled ETFE (CF-ETFE)
2A	Front thrust ring	Alpha sintered silicon carbide
3	Impeller	Carbon fiber filled ETFE (CF-ETFE)
3A	Impeller thrust ring	Fluorosint® or alpha sintered silicon carbide
4	Inner drive	Neodymium iron boron magnets encapsulated in pure, unfilled ETFE
4A	Bushing	Alpha sintered silicon carbide, Dri-Coat silicon carbide, or carbon
4B	Bushing retaining ring	PTFE
5	Shaft	Alpha sintered silicon carbide
6	Barrier	Molded pure, unfilled ETFE liner with carbon-fiber reinforced epoxy outer shell
6A	Barrier thrust ring	Alpha sintered silicon carbide
6B	Sealing ring	GF molybdenum disulfide-filled PTFE
7	Clamp ring	Powder coated ductile iron
8	Outer drive	Nickel plated neodymium iron boron magnets/ ductile iron
9	Motor adapter	Powder coated ductile iron
10	O-ring	FEP-encapsulated FKM, FKM, EPDM, Kalrez®, or Simriz®
11	Vapor Protection O-Rings	Buna N

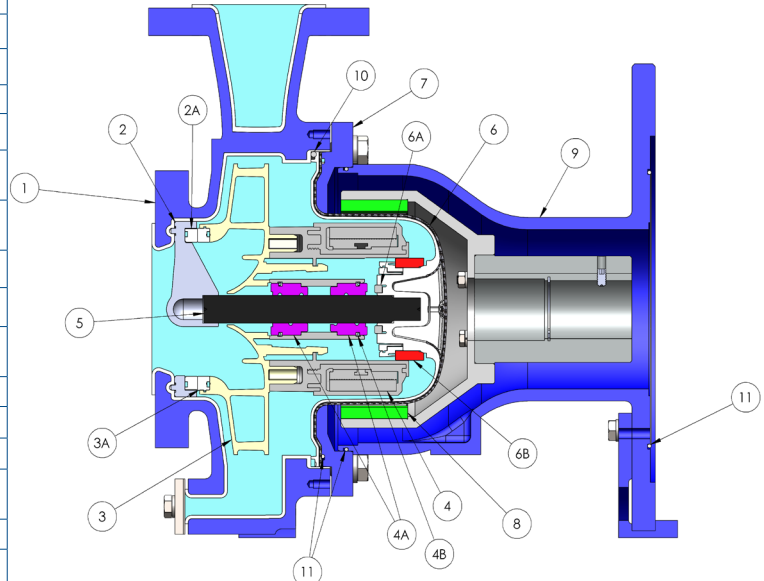

Kalrez® is a registered trademark of DuPont Performance Elastomers
 Simriz® Perfluoroelastomer is a registered trademark of Simriz® division of Freudenberg-NOK.
 Alfas® is a trademark of the Asahi Glass Co., Ltd.

SPECIFICATIONS

HP (kW)	Impeller Diameter	Suction	Discharge	Max. Flow 1750 rpm		Max. Head 1750 rpm		Max. Working Pressure psi (Bar)	Max. Viscosity cP	Max. Specific Gravity	Max. Temp.* °F (°C)
	in (cm)	in (cm)	in (cm)	gpm	m ³ /hr	ft.	m				
1 - 50 (1.1- 37)	8 - 10 1/2 (20.3 - 27)	4 (10.2)	3 (7.6)	1050	239	118	36	300 (21)	200	1.8	250 (121)

*Except E magnet set: maximum 220° F (104° C)
 Note: Impeller trims available every 1/8" (.32 cm) between the smallest and largest diameters.

DIMENSIONS

SIDE VIEW

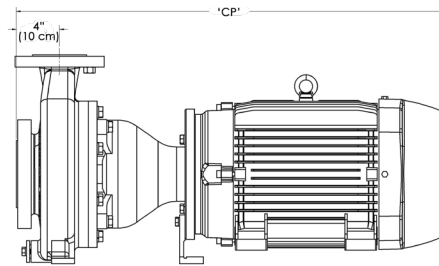

BOTTOM VIEW

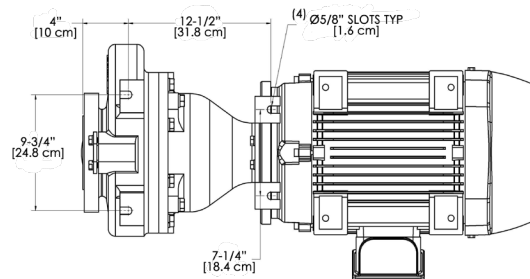

FRONT VIEW

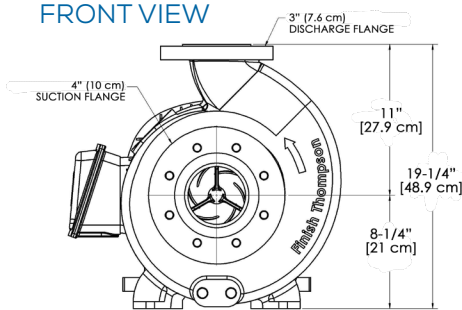

ANSI 150#, 300#, & ISO/DIN PN40 flanges are in compliance with bolting dimensions only.

Motor Frames	CP (approx.)	
	in	cm
NEMA		
143-145TC	27-11/16	70.3
182/184TC	29-9/16	75.1
213/215TC	32-5/8	82.9
254/256TC	37-1/2	95.3
282/284TC/TSC	39-27/32	101.2
324/326TC/TSC	44-21/32	113.4
364/365TC/TSC	46-27/32	119.0
404/405TSC	50-5/16	127.8
IEC		
90	27-15/32	69.8
100/112	28-29/32	73.4
132	32-9/16	82.7
160	38-9/32	97.2
180	40-9/16	103
200	43-3/32	109.5
225	46-21/32	118.5
250	52-17/32	133.4
280	56-3/4	144.1



finishthompson.com

FINISH THOMPSON INC. - HEADQUARTERS

921 Greengarden Road | Erie, PA 16501
 800.934.9384 | ph 814.455.4478 | fx 814.455.8518
 email sales@finishthompson.com

FINISH THOMPSON INC. - EUROPE CENTER

Otto-Hahn-Strasse 16 | Maintal, D-63477 Germany
 49 (0)6181-90878-0 | fx 49 (0)6181-90878-18
 email europecenter@finishthompson.com