



CECO Fybroc

FYBROC® SERIES 1500 HORIZONTAL

INSTALLATION

OPERATION

MAINTENANCE MANUAL

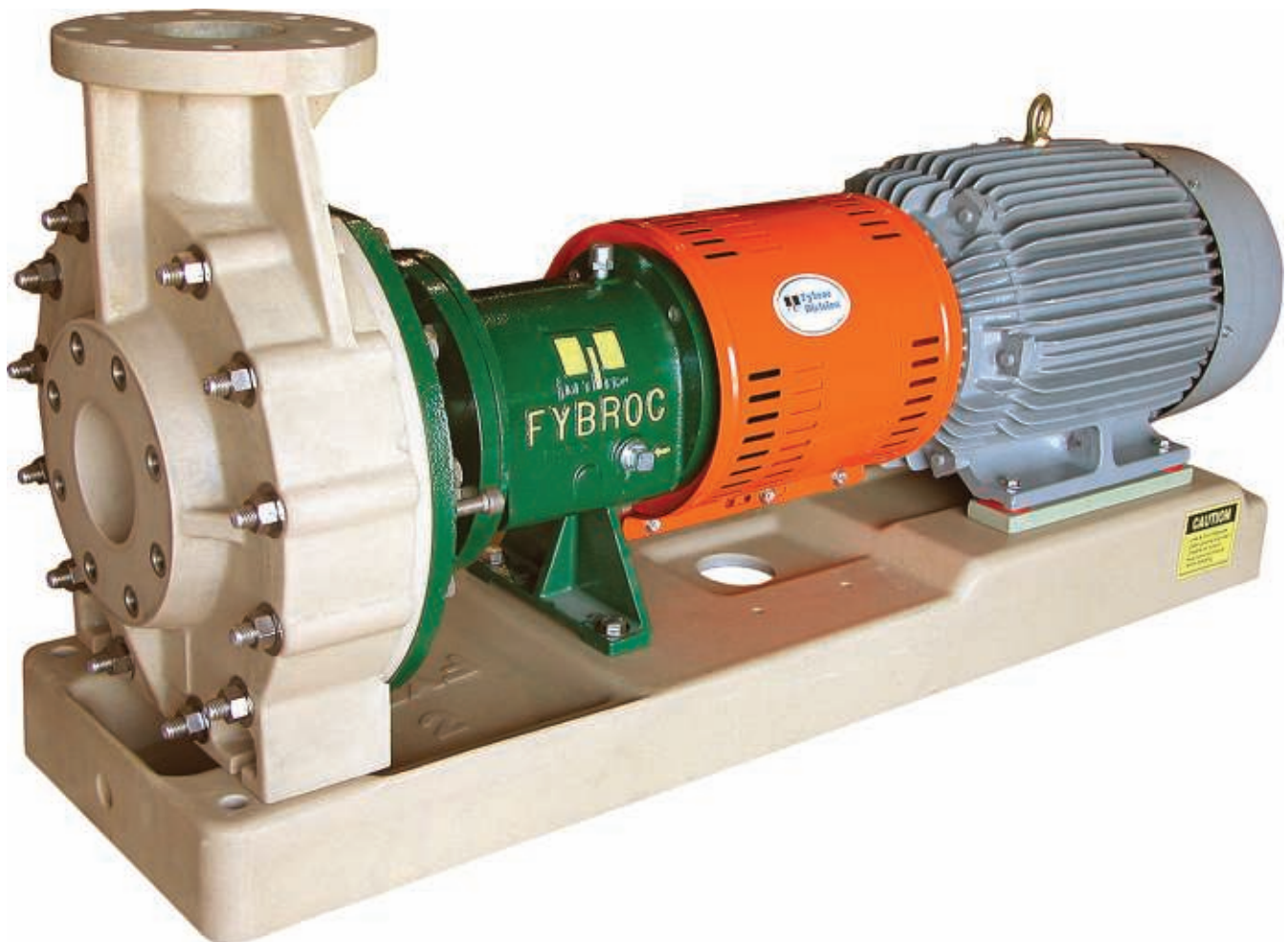

DO NOT INSTALL, OPERATE OR
SERVICE THIS PUMP BEFORE
READING THE ENTIRE MANUAL



INDEX

| | | | |
|---|----|---|----|
| Fybroc Warranty | 3 | Assembly/Disassembly Procedures | 14 |
| Safety | 4 | General | 14 |
| Installation Instructions | 8 | Disassembly | 14 |
| Location | 8 | Power-frame Disassembly | 15 |
| Foundation | 8 | Power-frame Assembly | 15 |
| Initial Alignment | 8 | Pump End Assembly | 16 |
| Piping the Pump | 9 | John Crane Type 8B2 | 16 |
| Suction Piping | 9 | John Crane Type 8-1T | 17 |
| Discharge Piping | 9 | John Crane Type 8-D | 18 |
| Ancillary Piping | 9 | Packed Stuffing Box | 18 |
| Electrical Connections | 10 | Impeller Adjustment | 19 |
| Rotation | 10 | Installation Instructions Flex-Type Couplings | 20 |
| Alignment and Coupling Installation | 10 | Operational Start-up Checklist | 22 |
| Start-up and Operating Procedures | 11 | Sectional Drawings | 23 |
| Lubrication | 11 | 1500 Group I | 23 |
| Oil Bath Lubrication | 11 | 1500 Group II | 24 |
| Re-Greasable Bearings | 11 | 1500 Group III | 25 |
| Greased for Life Bearings | 11 | Typical Mechanical Seal Installations | 26 |
| Seal Flushing | 11 | Product Flush | 26 |
| Mechanical Seals | 11 | External Flush | 27 |
| Packed Stuffing Box | 11 | Mechanical Seal Piping/Flow Requirements | 28 |
| Priming | 11 | Single Mechanical Seal | 28 |
| Starting | 11 | Double Mechanical Seal | 29 |
| Operational Check List | 12 | EU Declaration of Conformity | 30 |
| Maintenance | 12 | Read Warning..... | 31 |
| Pump | 12 | | |
| Oil Bath Lubrication | 12 | | |
| Re-Greasable Bearings | 12 | | |
| Greased for Life Bearings | 12 | | |
| Motor | 12 | | |
| Trouble Check List | 13 | | |

ORDERING REPLACEMENT PARTS

For future reference fill in the following information from the pump nameplate. This will be necessary to ensure accuracy when ordering replacement parts.

Model _____

Size _____

Serial Number _____

Impeller Diameter Installed _____

Seal Type _____

Material of Construction _____

WARRANTY

WARRANTY

FYBROC pumps are warranted by the Company, insofar as the same are of its own manufacture, against defects in materials and workmanship under proper and normal use and service, for a period of one year from the date of original shipment from the factory. FYBROC's obligation is limited, however, to furnishing without charge, F.O.B. its factory, new parts to replace any similar parts of its own manufacture so proving defective within said period, provided the Buyer has given FYBROC immediate written notice upon discovery of such defect. No allowance will be made for labor charges. FYBROC shall have the option of requiring the return of the defective material, transportation prepaid, to establish the claim.

FYBROC makes no warranty or guarantee whatsoever, either express or implied, of prime mover, starting equipment, electrical apparatus, parts or material not manufactured by Fybroc, except to the extent that warranty is made by the manufacturer of such equipment and material.

FYBROC assumes no liability for damages or delays caused by defective material, and no allowance will be made for local repair bills or expenses without the prior written approval or authority of FYBROC.

Under no circumstances will FYBROC be liable for indirect, special or consequential loss or damage of any kind and the Buyer assumes all liability for the consequences of its use or misuse by the Buyer, his employees, or others.

PERFORMANCE GUARANTEE

Is at the specified point of rating only and will not cover performance under conditions varying therefrom, nor for sustained performance over any period of time.

ACCEPTANCE TESTS

If required, shall be conducted in accordance with the practices as set forth in the Hydraulic Institute Standards. The expense of any such tests shall be borne by the buyer.

PERFORMANCE REPRESENTATIONS

Are based on shop laboratory tests with cold water as outlined in the Hydraulic Institute Standards.

FIELD TESTING

Due to the inaccuracies of field testing, the results of any such tests conducted by or for the Buyer shall be interpreted as being only indicative of the actual field performance of the pump. No equipment will be furnished on the basis of acceptance by results of field tests. If the buyer, after such a test, questions the performance of the pump, he may at his option request a test to establish the performance. Such tests will be conducted in accordance with the above paragraph entitled "Acceptance Tests."

ALL WARRANTIES

Are void if -

- a. Pipe strains are the cause of damage.
- b. Pump handles liquids other than those specified in detail.
- c. NPSH lower than required by pump impeller.
- d. Operating speed is higher than specified.
- e. Improper field installation.

RECOMMENDATIONS FOR SPECIAL MATERIALS

To combat corrosion, abrasion, erosion, or pumping solids, foreign objects, or pumping liquids at elevated temperature, any such recommendations will be based on the best available experience of FYBROC and the supplier of the material and industry, BUT WILL NOT CONSTITUTE A GUARANTEE AGAINST THESE EFFECTS.









The foregoing warranty is made in lieu of all other warranties guarantees, obligations or liabilities, expressed or implied, by FYBROC or its representatives. All statutory or implied warranties, other than of title, are hereby expressly negated and excluded.

All illustrations and provisions in specifications are descriptive and are not intended as warranties. Penalty of any kind are not acceptable unless approved in writing by an officer of CECO Environmental Corporation.

SAFETY

SYMBOLOLOGY TABLE

The following table contains the various safety symbols and explanations used throughout the manual.





| | |
|--|---|
|  | THIS SYMBOL REPRESENTS SAFETY INSTRUCTIONS THAT MUST BE FOLLOWED PREVENT PERSONAL INJURY OR LOSS OF LIFE. |
|  | THIS SYMBOL REPRESENTS AN AREA OR SITUATION WHERE CAUTION MUST BE TAKEN TO PREVENT PERSONNEL FROM BEING CAUGHT IN ROTATING MACHINERY. |
|  | THIS SYMBOL REPRESENTS THE POTENTIAL FOR A HOT SURFACE WHERE PRECAUTIONS MUST BE TAKEN TO PREVENT PERSONAL INJURY OR LOSS OF LIFE. |
|  | THIS SYMBOL REPRESENTS THE POTENTIAL FOR STRONG MAGNETIC FIELDS EXISTS WHERE PRECAUTIONS MUST BE TAKEN TO PREVENT PERSONAL INJURY OR LOSS OF LIFE. |
|  | THIS SYMBOL REPRESENTS THE POTENTIAL FOR AN ELECTRICAL SHOCK HAZARD IS PRESENT WHERE PRECAUTIONS MUST BE TAKEN TO PREVENT PERSONAL INJURY OR LOSS OF LIFE. |
|  | THIS SYMBOL REPRESENTS THE POTENTIAL FOR FLAMMABLE MATERIALS IN SOLID, LIQUID OR GAS FORMS CAN BE PRESENT AND WHERE PRECAUTIONS MUST BE TAKEN TO PREVENT PERSONAL INJURY OR LOSS OF LIFE. |
|  DANGER | HIGH RISK TO PERSONNEL SAFETY OR LOSS OF LIFE. |
|  CAUTION | MODERATE RISK TO PERSONNEL SAFETY OR POSSIBLE DAMAGE TO THE EQUIPMENT OR INSTALLATION. |
|  | SYMBOL REPRESENTS THE ATEX MARKING FOR EXPLOSIVE ATMOSPHERE ZONES. |

GENERAL

 The instructions detailed in this manual must be read in their entirety prior to installation, maintenance, operation, or start-up of the equipment. The equipment must not be put into service until all the conditions related to safety, noted in this manual, have been met. Failure to follow the given instructions is considered misuse of the product and shall not be covered under CECO Fybroc Pump warranty.





ACTIONS

The following are safety concerns and actions related to the proper use and maintenance of the equipment to prevent personal injury or damage to the equipment, installation, or environment.

-  All equipment should be de-energized prior to starting any work. Follow proper lock out / tag out procedures.
-  Guards must be in place and secure while the equipment is operational.
-  Block in and isolate the equipment from the attached process piping. Drain the equipment and piping prior to performing any work.
-  Never apply heat to remove the impeller from the shaft. Trapped vapor could cause an explosion.

WARNING

HAZARDOUS SITUATIONS MAY OCCUR UNLESS THIS EQUIPMENT IS APPLIED, INSTALLED, OPERATED, AND MAINTAINED BY THOROUGHLY QUALIFIED PERSONNEL IN STRICT ACCORDANCE WITH THE INSTRUCTION MANUAL AND ALL APPLICABLE DRAWINGS AND CODES.

-  READ THE INSTRUCTION MANUAL COMPLETELY BEFORE INSTALLING, FILLING, OPERATING, OR MAINTAINING THIS EQUIPMENT.
-  OBTAIN, READ AND HEED THE MSDS (MATERIAL SAFETY DATA SHEET) FOR THE FLUIDS BEING HANDLED BEFORE ATTEMPTING TO FILL, OPERATE OR MAINTAIN THIS EQUIPMENT. OBTAIN INSTRUCTIONS FROM THE SAFETY ENGINEER RESPONSIBLE FOR YOUR FACILITY BEFORE PERFORMING ANY WORK ON THE PUMPING EQUIPMENT AND SYSTEMS.
-  PROPER STORAGE WHILE NOT IN USE AND PROPER INSTALLATION AND STARTUP ARE ESSENTIAL FOR SUCCESSFUL PUMP OPERATION. MISUSE OR IMPROPER STORAGE, INSTALLATION OR OPERATION OF PUMPS MAY RESULT IN SERIOUS LOSS OR DAMAGE. CECO Fybroc DIVISION IS NOT RESPONSIBLE FOR ANY LOSS OR DAMAGE RESULTING FROM CAUSES BEYOND ITS CONTROL, AND IS NOT LIABLE FOR CHARGES FOR WORK PERFORMED OR MATERIALS FURNISHED TO REPAIR SUCH LOSS OR DAMAGE.
-  ALL INSTALLATION, OPERATION, AND MAINTENANCE MUST BE DONE BY THOROUGHLY QUALIFIED PERSONNEL IN STRICT ACCORDANCE WITH THIS MANUAL AND MUST COMPLY WITH ALL LOCAL, STATE AND FEDERAL CODES. ONLY CECO Fybroc AUTHORIZED SERVICE PARTS MUST BE USED IN THE REPAIR OF THESE PUMPS.

SAFETY

WARNING LABELS AND TAGS

The following warning labels are affixed to the pump by the manufacturer.



WARNING: ROTATING EQUIPMENT KEEP GUARDS IN PLACE

ALL GUARDS SHOULD BE KEPT IN PLACE AND SECURE DURING OPERATION. NEVER SHOULD THE EQUIPMENT BE ENERGIZED WITHOUT THE GUARDS IN PLACE

AND SECURE. SEVERE INJURY OR DEATH CAN RESULT IN CONTACTING THE ROTATING COMPONENTS OF THIS EQUIPMENT. LOOSE CLOTHING, JEWELRY AND HAIR SHOULD BE SECURED OR REMOVED PRIOR TO SERVICING THE EQUIPMENT.



WARNING: AUTOMATIC STOP AND START

THE EQUIPMENT HAS THE POTENTIAL OF BEING STARTED AND STOPPED AUTOMATICALLY. PROPER LOCK OUT / TAG OUT PROCEDURES SHOULD BE FOLLOWED TO INSURE THAT THE EQUIPMENT IS COMPLETELY DE-ENERGIZED PRIOR TO SERVICING.



NOTE: GROUNDING LUG

THE EQUIPMENT IS FURNISHED WITH A GROUNDING LUG TO BE USED TO PROPERLY GROUND THE COMPONENTS.

| | | | | | |
|---|-----------|-----------------------|---------------|----|--|
| CECO FYBROC 700 Emlen Way Telford, PA 18969 USA WWW.CECOENVIRO.COM | | CECO ENVIRONMENTAL | | CE | |
| MODEL & SIZE | | | SERIAL NO. | | |
| IMP. DIA. (MM) | SEAL TYPE | | BUILD YEAR | | |
| DESIGNATION | MAX P-BAR | MAX TEMP C | MATL OF CONST | | |
| M3/HR | TDH (M) | R.P.M. | KW | | |

SAFETY

RECEIVING AND INSPECTION

The Products of CECO Fybroc Division are subject to thorough and rigorous quality control and inspection procedures throughout the whole of the manufacturing process to assure proper operation in full conformity with established performance standards. On completion of inspection, each unit is coated with rust preventative, sealed against the entrance of dirt, and tagged with a signed certificate of inspection prior to shipment. Each pump when shipped is ready to perform the service for which it was designed with minimum maintenance and expense if properly installed and operated in accordance with the instructions furnished.

RECEIVING PUMP

WHEN THE PUMP IS RECEIVED FROM THE TRANSPORTATION COMPANY IT SHOULD BE PROMPTLY INSPECTED FOR DAMAGE AND SUCH DAMAGE NOTED ON THE BILL OF LADING BEFORE IT IS SIGNED. CLAIMS FOR SHIPPING DAMAGE MUST BE FILED AGAINST THE CARRIER.

CARE SHOULD BE EXERCISED IN UNLOADING AND HANDLING THE PUMP.



CAUTION

STORAGE

PUMPS MUST BE PROPERLY COVERED AND PROTECTED AGAINST MOISTURE, DIRT, AND PHYSICAL DAMAGE DURING STORAGE PRIOR TO INSTALLATION. IF PROLONGED STORAGE IS ANTICIPATED, A HEAVY PROTECTIVE COATING SHOULD BE APPLIED TO BEARINGS AND ALL EXPOSED MACHINED SURFACES.

A RUST PREVENTATIVE MUST BE USED TO PROTECT ALL STEEL OR CAST IRON PARTS. COMPRESSION PACKING OR MECHANICAL SEALS SHOULD BE REMOVED AND STORED AS WELL AS PROTECTED SEPARATELY.

PUMPS MUST ALSO BE PROTECTED FROM MOISTURE, DIRT, AND PHYSICAL DAMAGE DURING AND AFTER INSTALLATION WHILE THE SYSTEM IS BEING COMPLETED. PUMPS "STORED" ON THEIR FOUNDATIONS MUST BE COMPLETELY CHECKED FOR PROPER INSTALLATION PRIOR TO START-UP.

CARE IN STORAGE AND INSTALLATION WILL PRESERVE THE BUILT IN QUALITY OF EACH CECO FYBROC PRODUCT.

LIFTING AND HANDLING INSTRUCTIONS

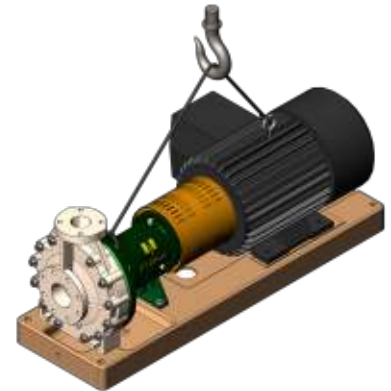
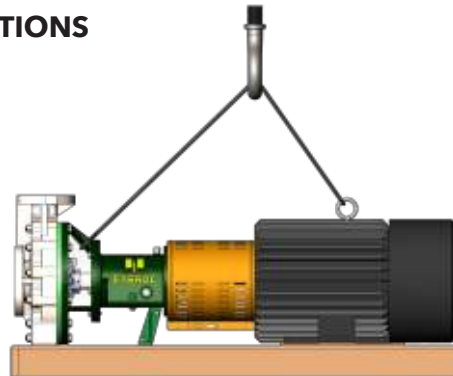

ALWAYS WEAR THE APPROPRIATE PROTECTIVE APPAREL WHEN WORKING ON OR AROUND THE PUMPING EQUIPMENT. SAFETY GLASSES WITH SIDE SHIELDS, HEAVY WORK GLOVES (USE INSULATED WORK GLOVES WHEN HANDLING HOT ITEMS), STEEL-TOED SHOES, HARD HAT, AND ANY OTHER PROTECTIVE GEAR AS NEEDED FOR PROTECTION. ONE EXAMPLE OF OTHER GEAR WOULD BE BREATHING APPARATUS WHEN WORKING NEAR TOXIC MATERIALS. USE LIFTING DEVICES, MANUFACTURED EXPRESSLY FOR THE PURPOSE OF LIFTING, TO MOVE THE PUMPING MACHINERY. DO NOT ATTEMPT TO LIFT THE ASSEMBLY OR ITS COMPONENTS MANUALLY. USE ONLY DEVICES WITH LIFTING CAPABILITIES IN EXCESS OF THE WEIGHT OF THE UNIT BEING LIFTED. INSPECT STRAPS, CHAINS, HOOKS, ETC. FOR DAMAGE AND LIFTING CAPABILITY BEFORE USE. LIFT ONLY AT THE CENTER OF GRAVITY.

PERSONAL INJURY, DEATH, AND/OR EQUIPMENT DAMAGE COULD OCCUR IF GOOD LIFTING PRACTICES ARE NOT USED.

SAFETY

| 1500 / 1530 - Noise Characteristics | | | | | | | | | |
|-------------------------------------|-------|------|--------------|------|--------------|------|--------------|------|--------------|
| Typical Sound Pressure Levels | | | | | | | | | |
| KW | HP | 3500 | | 2900 | | 1750 | | 1450 | |
| | | PUMP | PUMP & MOTOR | PUMP | PUMP & MOTOR | PUMP | PUMP & MOTOR | PUMP | PUMP & MOTOR |
| 0.55 | < .75 | 55 | 67 | 51 | 62 | 53 | 59 | 53 | 57 |
| 0.75 | 1 | 57 | 68 | 53 | 63 | 54 | 60 | 54 | 59 |
| 1.1 | 1.5 | 59 | 69 | 55 | 64 | 57 | 62 | 56 | 60 |
| 1.5 | 2 | 61 | 70 | 57 | 67 | 59 | 64 | 58 | 62 |
| 2.2 | 3 | 62 | 71 | 59 | 68 | 61 | 66 | 60 | 63 |
| 3 | 4 | 63 | 74 | 60 | 70 | 62 | 67 | 61 | 65 |
| 4 | 5 | 64 | 74 | 62 | 71 | 64 | 69 | 63 | 66 |
| 5.5 | 7.5 | 66 | 75 | 64 | 72 | 66 | 70 | 65 | 68 |
| 7.5 | 10 | 68 | 76 | 65 | 73 | 67 | 72 | 66 | 70 |
| 11 | 15 | 70 | 78 | 67 | 75 | 69 | 74 | 68 | 72 |
| 15 | 20 | 71 | 79 | 69 | 76 | 71 | 75 | 70 | 73 |
| 18.5 | 25 | 72 | 80 | 70 | 76 | 72 | 75 | 71 | 74 |
| 22 | 30 | 74 | 81 | 71 | 78 | 73 | 76 | 72 | 74 |
| 30 | 40 | 75 | 81 | 73 | 78 | 74 | 77 | 73 | 75 |
| 37 | 50 | 76 | 82 | 74 | 79 | 75 | 78 | 74 | 77 |
| 45 | 60 | 77 | 83 | 75 | 80 | 76 | 80 | 75 | 78 |
| 55 | 75 | 79 | 84 | 76 | 81 | 78 | 81 | 77 | 79 |
| 75 | 100 | 80 | 85 | 78 | 82 | 79 | 82 | 78 | 80 |
| 90 | 120 | 81 | 86 | 79 | 83 | 80 | 83 | 79 | 81 |
| 110 | 150 | 82 | 87 | 80 | 84 | 81 | 84 | 80 | 82 |
| 150 | 200 | 84 | 89 | 82 | 86 | 84 | 85 | 83 | 83 |

*Sound pressure level LpA measured at 1m reference distance from pump
Tolerance = +/- 3 dBA*

INSTALLATION HORIZONTAL PUMPS

LOCATION

The pump should ideally be placed as close as possible to the liquid supply source. Allow sufficient space on the sides and overhead to permit inspection and maintenance work to be performed.

FOUNDATION

The foundation for the pump should be level, provide rigid support and alignment of pump and motor. It should also be of sufficient mass to dampen any vibrations developed. Typically this is accomplished by installing and grouting a Fybroc baseplate on a concrete foundation.

Foundation bolts of the proper size should be embedded in the concrete with anti-rotation lugs, located by a drawing or template. (See Figure 1 and Table 1 below for bolt-size and locations). A pipe sleeve larger than the bolt should be used to allow enough lateral movement for final positioning of the bolts. (See Figure 2 below). Leveling wedges or shims should be placed under the sides of the baseplate to level the unit and the foundation bolts slightly tightened.

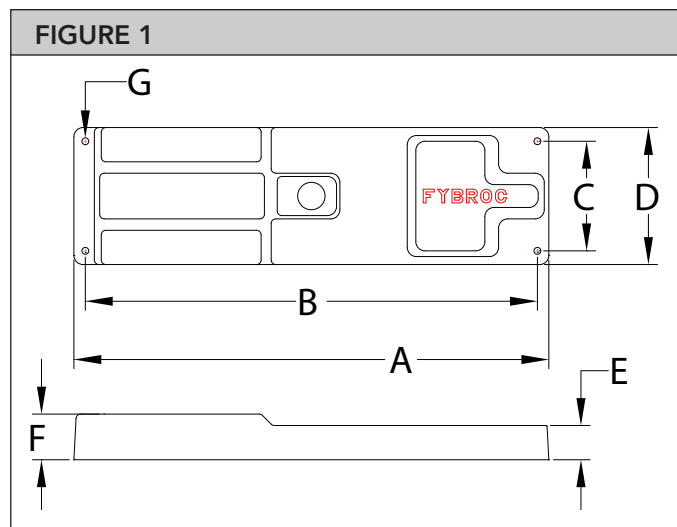

A wood form can now be built around the edge of the baseplate to contain the grout. The top of the rough concrete foundation should be wetted down prior to grouting. A good grade of non-shrinking grout can now be poured through the fill hole on the top of the fiberglass baseplate. On baseplates with raised motor mounting sections, a short length of pipe or tubing can be fitted into the grout hole to allow the grout to completely fill the raised section to the baseplate up to the vent hole in the raised section, as shown in figure below. Once the grout starts to set, the extension can be removed, leaving the grout level with the top of the baseplate. Once the grout has fully hardened, usually about 48 hours after pouring, the foundation bolts can be fully tightened.

| Base Plate | Units | A | B | C | D | E | F | G | Bolt Size |
|------------|-------|--------|--------|-------|-------|-------|-------|------|-----------|
| 1T | inch | 35 | 32.5 | 8 | 10 | 2.63 | 3.38 | 0.75 | 1/2 |
| | mm | 889.0 | 825.5 | 203.2 | 254.0 | 66.7 | 85.7 | 19.1 | |
| 2T | inch | 39 | 36.5 | 9 | 12 | 2.88 | 2.88 | 0.75 | 1/2 |
| | mm | 990.6 | 927.1 | 228.6 | 304.8 | 73.0 | 73.0 | 19.1 | |
| 1 | inch | 45 | 42.5 | 9 | 12 | 3.75 | 2.75 | 0.75 | 1/2 |
| | mm | 1143.0 | 1079.5 | 228.6 | 304.8 | 95.3 | 69.9 | 19.1 | |
| 2 | inch | 52 | 49.5 | 12 | 15 | 3.75 | 3.75 | 0.75 | 1/2 |
| | mm | 1320.8 | 1257.3 | 304.8 | 381.0 | 95.3 | 95.3 | 19.1 | |
| 3 | inch | 58 | 55.5 | 15 | 18 | 4.00 | 4.00 | 1.00 | 3/4 |
| | mm | 1473.2 | 1409.7 | 381.0 | 457.2 | 101.6 | 101.6 | 25.4 | |
| 4 | inch | 60 | 57.5 | 15 | 18 | 4.00 | 4.00 | 1.00 | 3/4 |
| | mm | 1524.0 | 1460.5 | 381.0 | 457.2 | 101.6 | 101.6 | 25.4 | |
| 5 | inch | 68 | 65.5 | 19 | 22 | 4.50 | 4.50 | 1.00 | 3/4 |
| | mm | 1727.2 | 1663.7 | 482.6 | 558.8 | 114.3 | 114.3 | 25.4 | |
| 6 | inch | 80 | 77.5 | 19 | 22 | 4.50 | 4.50 | 1.00 | 3/4 |
| | mm | 2032.0 | 1968.5 | 482.6 | 558.8 | 114.3 | 114.3 | 25.4 | |

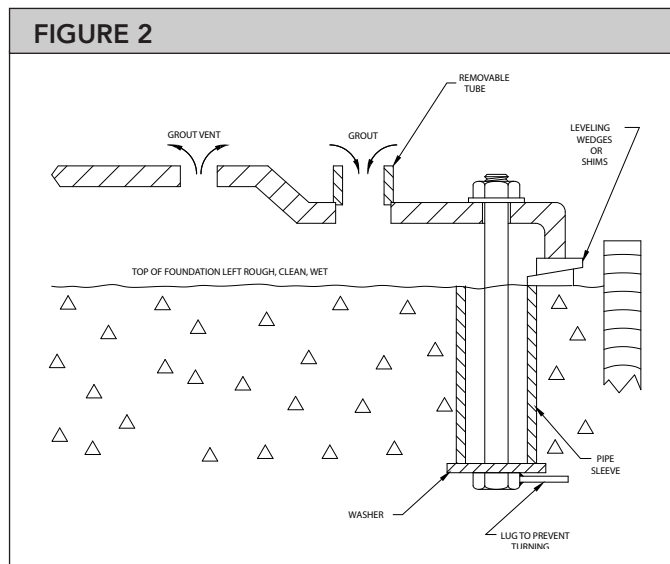

INITIAL ALIGNMENT

Final alignment of the pump and driver through the flexible coupling is of **extreme importance** for trouble free mechanical operation. If the driver was mounted at the factory, the unit was rough aligned with plastic shims prior to shipment. These shims are not to be considered permanent and should be replaced with metal shims during final alignment. In addition, during transit and subsequent handling any factory alignment may be disturbed. All units must be re-aligned after installation and/or maintenance.

The following steps are suggested to establish the initial alignment of the pump unit:

- 1) Be sure the foundation bolts are tight.
- 2) Be sure the casing and frame feet are tight.
- 3) Use metal shims under the driver feet to establish parallel and angular alignment of pump and motor shafts.

INSTALLATION HORIZONTAL PUMPS

PIPING THE PUMP

Piping must not be connected to the pump until base, pump, and driver are initially aligned, failure to do so may result in the inability to attain proper alignment later.



WARNING

ALL FLANGED CONNECTIONS TO THE PUMP SHOULD BE FULL FLAT FACE WITH FULL CONTACT GASKETS. RAISED FACE FLANGES OR PARTIAL CONTACT GASKETS SHOULD NOT BE USED AS EXCESSIVE STRAINS CAN BE APPLIED TO THE PUMP FLANGES UPON TIGHTENING.

The pump has been designed with all necessary strength factors for long, reliable service life. However, due to the composite construction, care must be taken during installation to avoid unnecessary pipe strain. If severe piping strains are to be encountered, flexible connections are recommended in the suction and discharge pipe lines. When lined piping is used, flange alignment should be carefully checked. Spacer ring gaskets are recommended to assure parallel alignment of pipe and pump flanges. The following flange bolt torque values should be used:

| Flange Size | Bolt Torque |
|-------------|------------------------------|
| 1-1/2" | 9-12 ft-lbs (12.2-16.2 N-m) |
| 2" | 18-24 ft-lbs (24.4-32.5 N-m) |
| 3" | 23-30 ft-lbs (34.4-40.6 N-m) |
| 4" | 27-36 ft-lbs (36.6-48.8 N-m) |
| 6" & Larger | 35-50 ft-lbs (47.5-67.8 N-m) |

All piping must be supported independently of the pump. The piping should always line up naturally with the pump flanges. Never draw the piping to the suction or discharge flanges of the pump. Outside installations should be properly compensated for changes in ambient temperatures. Refer to pipe manufacturers standards for proper installation. Omission of this could result in severe strain transmitted to the pump flanges.

The piping should be as short and direct as possible. Avoid all unnecessary elbows, bends and fittings, as they increase friction losses in the piping.

SUCTION PIPING

- To minimize friction loss, the length of the suction pipe (from process to pump inlet) should be as short as possible. It is important that NPSH available to the pump is greater than the NPSH required by the pump, long suction runs greatly affect NPSH and should be considered carefully. See pump performance curve for NPSH requirements.
- The diameter of the suction pipe should be as large as the pump suction. If long suction runs are encountered, the suction pipe diameter should be

increased to reduce the NPSH required.

- Increases or reducers, if used, should be eccentric and installed with the eccentric side on the bottom of the pipe to prevent air traps.
- Elbows, fittings, valves or expansion joints should be avoided at the suction flange. Allow a straight run of at least 10 pipe diameters into the suction of the pump.
- If a valve is to be installed in the suction piping, only full flow valves offering a minimum flow disturbance should be used (ball, plug types). These valves should be for shut-off only when the pump is not running, and not for throttling or controlling flow. Centrifugal pumps should never be throttled on the suction side.
- Provisions for a suction pressure gauge should be included.

DISCHARGE PIPING

- Installation of a valve in the discharge line that can be used as a block for inspection and maintenance is recommended. It should be of a design to allow throttling or flow control.
- The diameter of the discharge pipe should be as large or larger than the pump discharge.
- Provision for a discharge pressure gauge should be included.

ANCILLARY PIPING

- The diameter of the ancillary or seal piping should be large enough to meet the seal flushing requirements. Typically this is 1/4-1/2 GPM at a pressure of 15-25 PSI above the suction pressure for most mechanical seals. Refer to pages 25 and 26 for recommended seal flush flow rates and piping installations.
- Where the ancillary piping is connected to the pump only plastic fittings shall be used.



WARNING

FAILURE TO USE PLASTIC FITTINGS MAY RESULT IN DAMAGE TO THE PUMP.

- Many modern flush systems incorporate electrically actuated solenoid valves to conserve and control the flow of flush liquids, ensure that the flush liquid is flowing to the seal before the pump is started.
- On double seal arrangements with flush in and flush out connections, flow control valves should be installed in the flush out or downstream side.

The pump shaft should turn freely by hand after the piping has been connected to the pump. This is to insure that the piping has not caused binding in the pump. If binding occurs, check alignment and realign if necessary.

INSTALLATION HORIZONTAL PUMPS

ELECTRICAL CONNECTIONS

- A) All electrical work done to the unit should be done by a qualified electrician. All local, state and federal electrical codes should be adhered to.
- B) Before any motor wiring is done, make sure motor shaft is disengaged from pump shaft by removing coupling sleeve.

**WARNING**

DO NOT START 1500 SERIES PUMPS WITH COUPLING SLEEVE INSTALLED UNTIL CORRECT MOTOR ROTATION HAS BEEN DETERMINED, AS DAMAGE COULD RESULT FROM REVERSE ROTATION.

- C) Wire motor according to motor manufacturers instructions. Ensure that all connections and covers are tight and that proper sized wire and switch-gear are used.

ROTATION

All pumps operate in a clockwise direction when viewed from the coupling end of the pump shaft, (see direction arrow on the pump bearing-frame). Connect electric motor to power supply and jog motor to check rotation. If motor is operating in wrong direction, reverse leads and recheck. With correct motor rotation established, reinstall coupling sleeve and coupling guard.

**WARNING**

DO NOT START PUMP WITH COUPLING SLEEVE ENGAGED UNTIL BEARING FRAME HAS BEEN PROPERLY LUBRICATED AND MECHANICAL SEAL IS PROPERLY FLUSHED.

ALIGNMENT AND COUPLING INSTALLATION

Accurate alignment of the pump and driver is of extreme importance for long term trouble-free mechanical operation.

Closer alignment will result in reduced vibration levels and longer expected bearing life. Most Fybroc pumps are supplied with flex-type couplings as standard equipment, for specific installation instructions refer to page 17. If a different coupling is supplied, specific installation instructions will be included with the pump.

START-UP AND OPERATING PROCEDURES

LUBRICATION

Oil Bath Lubrication

When the power-frame is the oil bath lubrication type (standard construction), the bearing frame housing is NOT lubricated at the Fybroc factory. Lubricant MUST be added to the bearing frame prior to pump start-up.

A high-quality turbine type non-detergent oil, with rust and oxidation inhibitors should be used. For the majority of operating conditions, the oil temperature should run between 50°F (10°C) and 180°F(82°C). In this range, an oil of 300 SSU viscosity at 100°F (38°C), (approximately SAE-20) should be used.

Remove the oil fill plug (Item 19) and fill the bearing-frame with oil through the oil fill port. Add oil until the oil level is centered in the sight glass (Item 19G). There is an arrow in the casting to mark the center of the sight glass.



WARNING

DO NOT FILL BEARING FRAME THROUGH THE BREATHER CONNECTION AS OVER FILLING IS POSSIBLE, RESULTING IN OIL LEAKAGE AND EXCESSIVE BEARING TEMPERATURES.

Approximate Bearing Frame Oil Capacity:

Group I – 3/4 pint

Group II – 2 1/2 pints

Group III – 6 pints

Re-Greasable Bearings

When the power-frame assembly is the re-greasable bearing type, the bearings are initially lubricated at the factory.

Greased For Life Bearings

When the power-frame assembly is supplied with greased for life bearings there is no action required.

SEAL FLUSHING

Mechanical Seal

Do not operate the pump without liquid to the mechanical seal. Depending on the flush arrangement of the pump, the fluid to the seal may be piped from the pump discharge externally or internally, or from an external clean source. If the pump is fitted with an internal or bypass flush arrangement, then the pump must be flooded with liquid prior to starting to ensure that the mechanical seal is lubricated. If the pump is equipped for an external flush system, then flush liquid must be supplied to the seal prior to starting. Proper flow for external flushing will vary from 1/4 to 1/2 GPM at a pressure of 15 to 25 PSI above the stuffing box pressure.

Packed Stuffing Box

This method of sealing the pump requires an external flush line for the intake of flush liquid. The flush line must supply liquid to the packing prior to operation. The packing gland must be adjusted at start-up of the pump for proper operation. When the pump is put into operation, the gland should be considerably loose. After the pump is operating, the gland should be slowly tightened to reduce the amount of leakage. Each time the packing is tightened the amount of flush liquid will decrease, however as the packing warms up it will swell slowing the flow of flush liquid even more. A slight flow of liquid from the stuffing box is necessary to provide lubrication and cooling (approximately 40 - 60 drops per minute after the packing has run in).



WARNING

PACKING CONTAINING FLUOROCARBON COMPOUNDS MUST BE CONSTANTLY CHECKED WHEN FIRST STARTED AS IT HAS A TENDENCY TO RAPIDLY EXPAND FROM TEMPERATURE CHANGES RESULTING IN BLOCKAGE OF THE FLUSH LIQUID, FAILURE TO DO SO MAY RESULT IN DAMAGE TO THE PUMP.

PRIMING

Suction valve must be fully open. The pump casing and suction pipe must always be full of liquid before the pump is started. Centerline discharge designs are self-venting therefore the discharge valve should be opened to release any air trapped in the pump and then left slightly open at start-up.

STARTING

Prior to starting, turn pump shaft by hand to be sure rotating elements are free. If it rubs or binds:

- A) Check alignment.
- B) Check for piping strains on casing flanges, or other loads on casing.
- C) Check impeller clearance. (See impeller adjustment).

With pump rotating elements free, replace coupling guard.

Prior to starting pump recheck installation procedures with the operational start-up checklist found on page 19 of this manual.

Start pump and bring up to speed, open discharge valve to the rated flow.



WARNING

DO NOT RUN PUMP WITH A CLOSED DISCHARGE VALVE AS THE LIQUID IN THE PUMP WILL RAPIDLY INCREASE IN TEMPERATURE, POSSIBLY CAUSING DAMAGE TO PUMP.

START-UP AND OPERATING PROCEDURES

Check flush water to mechanical seal, if not lubricated from the pump discharge.

Check oil levels in the bearing frame.

If the pump is provided with packing, the gland should be adjusted (while running) to allow leakage of approximately 60 drops per minute.

EXERCISE EXTREME CAUTION.

OPERATIONAL CHECK LIST

- A) Periodically check stuffing box for leakage with packing, and no leakage with mechanical seals.
- B) Periodically check lubrication to the pump and driver bearings.
- C) Periodically check for excessive vibrations and oil temperatures. Correct if necessary.

MAINTENANCE

Fybroc pumps are designed for a long service life. The only scheduled maintenance items are the lubrication intervals for the pump and motor. Please refer to the lubrication procedures given in the start-up section.

PUMP

Oil Bath Lubrication

The frequency with which the oil in the powerframe should be changed depends greatly on the operating temperature and the cleanliness of the environment. For power-frames running at approximately 122°F (50°C), typically the lower speed pumps, the oil should be changed once a year. For power-frames running at approximately 167°F (75°C) the oil should be changed every six months. If the environment is hostile, the lubrication intervals should be reduced.

Re-Greasable Bearings

The frequency with which the grease in the powerframe should be changed depends greatly on the operating time and the cleanliness of the environment. For power-frames running at 2900-3500 rpm the bearings should be re-lubricated every 5,000 hrs, for all other speeds every 10,000 hrs.

Before greasing, be sure fittings are clean and free from dirt. Remove the 1/8" grease relief plugs for the front and rear bearings. Using a standard grease-gun inject grease into the bearing using the grease fittings until grease comes out of the bleed holes. Allow the pump to operate approximately 2 hours before replacing the pipe-plugs, this will allow any excess grease to purge itself.



WARNING

FAILURE TO REMOVE THE PURGE PLUGS WHEN FILLING THE BEARINGS WITH GREASE MAY RESULT IN DAMAGE TO THE BEARING SEALS.

Greased For Life Bearings

Greased for life bearings require no maintenance.

MOTOR

The motor re-lubrication intervals are greatly influenced by the environment it is in and the length of time it runs. Refer to the following chart for typical re-lubrication values for motors. Standard duty is when the motor is operated eight hours a day and the environment is free from dust. Severe duty is when the motor runs twenty-four hours per day with exposure to dirt and dust.

| Sync RPM Range | Motor Frame Range | Type of Service | |
|----------------|-------------------|-----------------|-------------|
| | | Standard Duty | Severe Duty |
| 3600 / 3000 | 143T - 256T | 5 Yrs | 3 Yrs |
| | 284T - 286T | 1 Yr | 4 Mos |
| | 324T - 365T | 9 Mos | 3 Mos |
| 1800 / 1500 | 143T - 256T | 7 Yrs | 3 Yrs |
| | 284 - 326T | 4 Yrs | 1.5 Yrs |
| | 364T - 365T | 2.5 Yrs | 10 Mos |
| | 404T - 447T | 2 Yrs | 8 Mos |
| 1200 / 1000 | 143T - 256T | 7 Yrs | 3 Yrs |
| | 284T - 326T | 4 Yrs | 1.5 Yrs |
| | 364T - 447T | 3 Yrs | 1 Yr |

Instructions For Lubricating Motors

Before greasing, be sure fittings are clean and free from dirt. Remove grease relief plug or plate and using a low pressure grease gun pump in the required grease. Do not over-grease. After relubricating allow motor to run for an hour before replacing relief hardware.

START-UP AND OPERATING PROCEDURES

TROUBLE CHECK LIST

Refer to the following diagnostic section if hydraulic problems are encountered in the pump operation.

PROBLEM: Not enough liquid, or no liquid delivered.

CHECK: Suction pipe and /or pump casing not filled with liquid.

Speed too low. (Result, reduced TDH).

Suction lift too high or insufficient NPSHA. (Cavitation).

Impeller or suction pipe plugged with solids.

Wrong rotation. (Result, reduced TDH).

Air pockets in suction line or air leaking in through packing box area.

Suction strainer plugged, if used in suction line.

PROBLEM: Not enough pressure.

CHECK: Speed too low.

Air or gases in the liquid.

Check impeller diameter.

Mechanical defects (impeller clearance too great; impeller damaged).

Wrong rotation.

Pressure gauge in a poor location.

PROBLEM: Pump runs but intermittently pumps liquid.

CHECK: Suction line leaks.

Stuffing box leakage of air.

Air pocket in suction line.

Insufficient NPSH.

Air or gases in liquid.

PROBLEM: Pump takes too much power.

CHECK: Speed too high.

Head lower than rating; pumping beyond design point.

Liquid heavier than specified; check viscosity and specific gravity.

Mechanical defects (Bent shaft, rotating element binds, packing too tight, misalignment).

ASSEMBLY/DISASSEMBLY PROCEDURES FOR HORIZONTAL PUMPS

GENERAL

The Fybroc pump is designed for easy inspection and service because of its back pullout construction. For inspection or replacement of certain parts, the work can be done in place, without the necessity to remove the complete pump to a maintenance area. Refer to applicable Sectional Drawing in this manual for item numbers mentioned below.

Before any work is done the following procedures and precautions should be taken:

- 1) The electric motor should be either disconnected from its power source, or the switch or circuit breaker must be secured in an "off" position so that the motor cannot be accidentally started.



WARNING

WORKING ON PARTIALLY OR FULLY ENERGIZED EQUIPMENT CAN RESULT IN SEVERE INJURY OR DEATH.

- 2) Depending upon the fluid being pumped, the proper protective equipment should be worn (gloves, mask, respirator, goggles or safety glasses, etc.) to prevent contact with the fluid in the pump or pipelines.
- 3) Check the valves on the suction and discharge lines to be sure they are closed and secured.
- 4) If the mechanical seal is flushed from an external source, turn off the valve in the supply line and disconnect the flush line.
- 5) The liquid trapped in the pump and piping should be carefully vented and drained. Care should be taken to either trap the fluid in a container or to divert it to a proper disposal area so that the area around the pump and base will not be contaminated.

DISASSEMBLY

- 1) Remove the bolts securing the coupling guard and remove the coupling guard.
- 2) If a standard flex-type coupling is used, refer to the coupling instructions in this manual for proper disassembly of the coupling. If another type coupling was used, refer to the coupling manufacturer's data that was included with the pump.
- 3) If the complete pump is to be removed to a maintenance area, remove the bolts holding the power-frame and casing to the baseplate. Next remove the bolts on the suction and discharge flange connections. Now the whole pump can be removed. If the casing is to be left in place remove the screws holding the power-frame to the baseplate and then remove the casing bolts, nuts and washers securing the casing to the cover and frame adapter (Items 1C, 1D, 1E). Now the rotating assembly can be pulled away from the casing and removed. Two jackscrews

(Item 19D) are provided to ease disassembly.

- 4) If the casing was removed with the pump, remove the through bolts, nuts and washers securing the casing to the cover and frame adapter (Items 1C, 1D, 1E). Now the casing can be pulled away from the power-frame and cover. Two jackscrews (Item 19D) are provided to ease disassembly. The pump rotating assembly can be placed in a convenient location to disassemble.
- 5) Remove the cover o-ring (Item 73) and place into a container with the casing hardware.
- 6) If the pump is provided with a mechanical seal utilizing set screws to drive the seal, loosen the set screws. If the mechanical seal is of the preset outside type, re-install seal setting clips, before loosening set screws.
- 7) The impeller assembly can now be removed by fixing the pump shaft at the coupling end and turning the impeller in a counter-clock wise direction facing the impeller. A strap wrench or similar device may be required to disengage the screw threads. The impeller, cover, and seal assembly can now be removed as a unit by unthreading the assembly off the pump shaft. If the pump is provided with a separate shaft sleeve, remove the impeller and impeller o-ring (Items 2 and 2B). Proceed to remove the cover, separate sleeve and seal assembly.
- 8) If the mechanical seal is a single outside seal, be sure the set screws are loose and pull the rotary seal assembly off the sleeve using a twisting motion as it is removed. The integral sleeved impeller (Item 2) can now be removed from the cover. Remove the four bolts and washers (Item 17C, 17E) securing the gland (Item 17) to the cover (Item 11) and remove the gland and then the seal stationary member from the cover. The carbon and ceramic elements of the seal should be handled carefully to prevent chipping or scratching.

If the mechanical seal is a double inside seal, remove the four bolts and washers (Item 17C, 17E) securing the gland (Item 17) to the cover (Item 11) and remove the gland. Be sure the set screws are loose and pull the rotary seal assembly off the sleeve using a twisting motion as it is removed. The integral sleeved impeller (Item 2) can be removed from the cover. Next remove the stationary seal faces from the gland and cover by gently pressing them out using your thumbs. The carbon and ceramic elements of the seal should be handled carefully to prevent chipping or scratching.

If packing is supplied with the pump then first remove the upper four nuts and washers securing the gland and remove the gland. Next remove the lower four nuts and washers and remove the stuffing box extension. Now remove the packing rings and lantern ring, keeping them in order to preserve the location of the lantern ring. The gland studs can now be removed from the cover.

ASSEMBLY/DISASSEMBLY PROCEDURES FOR HORIZONTAL PUMPS

POWER-FRAME DISASSEMBLY

After removing the pump casing, impeller, and cover assembly from the power-frame, proceed with the following:

- 1) Drain oil from the power-frame assembly by removing the drain plug (Item 19A). Collect oil into a suitable container.
- 2) Remove the deflector, if the pump utilizes oil seals, (Item 40) by sliding off the shaft.
- 3) Remove only the adjusting screws (Item 33A) that secure the bearing housing (Item 33) to the power-frame (Item 19).
- 4) The shaft assembly is now ready for removal. Slowly and evenly turn the remaining adjusting jacking screws (Item 33A) until the outboard bearing housing (Item 33) clears the frame (Item 19). This will require the use of shims or barstock being placed between the adjusting jacking screws and bearing frame. The adjusting jacking screws by themselves are not long enough to effect complete clearance from the frame. Be careful when removing the shaft assembly not to damage the impeller threads on the end of the shaft by contacting the cast-iron. You now should be holding the shaft, bearings, and outboard bearing housing assembly.
- 5) Remove the shaft and bearing assembly from the outboard bearing housing, by removing the internal retaining ring (Item 18A). Lightly tap the outboard shaft end with a soft-headed mallet until the outboard bearing clears the bearing housing (Item 33).
- 6) Remove the outboard bearing (Item 18) from the shaft by disengaging the tang on the lockwasher (Item 69) from the lock-nut (Item 22), and then remove the lock-nut with a bearing lock-nut wrench or by tapping the groove in the lock-nut with a hammer and drift. The bearing can now be pressed from the shaft.
- 7) Remove the internal retaining ring (Item 18A) from the shaft.
- 8) Remove the inboard bearing (Item 16) by pressing from the shaft. Protect the impeller threads and coupling end of the shaft from damage when pressing bearings off the shaft.
- 9A) If the bearing frame is provided with labyrinth type oil seals, and they are still in good condition they can remain in the bearing frame and bearing housing. If replacement is necessary they can be pressed out of their respective housings.
- 9B) If the bearing frame is provided with lip type oil seals, remove the oil seals (Items 47 & 49) from the outboard bearing housing and from the power-frame. These seals are removed by lightly tapping with a soft-headed mallet. Note: these seals should not be reused

after disassembly.

- 10) Remove the o-ring seal (Item 33B) from the bearing housing.
- 11) If separate, remove the bearing frame adapter screws (Item 71A) and remove the adapter (Item 71). Remove the casing jack-screws (Item 19D) from the adapter.
- 12) If separate, remove the frame-leg screws (Item 19F) and remove the frame-leg (Item 19E).
- 13) Remove the sight-glass, breather and plugs (Items 19A, 19B, 19C, 19G and 19H) from their respective locations.

POWER-FRAME ASSEMBLY

- 1) Clean and visually inspect all parts prior to reassembly. Particularly note condition of shaft surfaces and housing bores where oil seals contact.
- 2) Evenly heat bearings up to 167°F (75°C) above room temperature, approximately 239°F (115°C). Do not exceed 257°F (125°C) as damage to the bearings may occur.



WARNING: SINCE THE SHAFT IS TYPICALLY MADE OF STAINLESS STEEL, PRESSING THE BEARINGS ON THE SHAFT MAY RESULT IN DAMAGE TO THE SHAFT.

- 3) Note orientation of bearings before installing on shaft:
 - Outboard Bearing (coupling end) – If bearing contains ball filling slots, the slots should be facing the coupling (key-way) end of shaft. If the bearing has a single shield, the shield faces toward the coupling end of the shaft. If the pump is provided with re-greasable bearings, the bearing grease shield should face the impeller (threaded) end of shaft.
 - Inboard Bearing (impeller end) – If bearing contains ball filling slots, the slots should be facing the coupling (key-way) end of shaft. If the bearing has a single shield, the shield faces toward the threaded end of the shaft. If the pump is provided with re-greasable bearings, the bearing grease shield should face the coupling (key-way) end of shaft.
- 4) Install the outboard bearing (Item 18) on the shaft (Item 6) by sliding it over the key-way end of the shaft until it is seated squarely against the shaft shoulder.
- 5) Place the retaining ring (Item 18A) over the shaft before installing the inboard bearing, as this is impossible to install later.
- 6) Install the inboard bearing (Item 16) on the shaft (Item 6) by sliding it over the threaded end of the shaft until it is seated squarely against the shaft shoulder.

ASSEMBLY/DISASSEMBLY PROCEDURES FOR HORIZONTAL PUMPS

- 7) Install the lock-washer (Item 69) and lock-nut (Item 22) against the outboard bearing and then tighten the lock-nut with a bearing locknut wrench or by tapping the groove in the lock-nut with a hammer and drift. The lock-nut can then be secured by bending the tang on the lock-washer into the groove on the locknut. Be careful not to mar the oil seal surfaces of the shaft which are in close proximity to the bearings and lock-nut.
- 8) Install the o-ring seal (Item 33B) on the bearing housing.
- 9) If the bearing frame is provided with labyrinth type oil seals, lubricate the seal o-rings and press fit the labyrinth seals (Items 47 & 49) into the bearing housing and bearing frame bores.
- 10) Install the shaft and bearing assembly into the bearing housing (Item 33), by first lubricating the bore with some oil and then sliding in the shaft assembly. Lightly tap the bearing housing with a soft-headed mallet until the outboard bearing clears the retaining ring groove. Using snap-ring pliers install the retaining ring (Item 18A) with the opening in the ring lining up with the oil return slot in the bearing housing.
- 11) If the bearing frame is provided with lip type oil seals, install the outboard oil seal (Item 49) into the bearing housing. Lubricate the ID of the seal and place sealant around the OD of the seal. Carefully place the oil-seal over the shaft watching out for sharp edges such as on key-ways and place up against the bore. Seat the oil-seal in place with a soft-faced tool applying force evenly around the outer edge to avoid cocking the seal. Wipe off any excess sealant.
- 12) The shaft assembly is now ready for installation. Ensure that the power-frame is free of contaminants and then lubricate the bores in the powerframe with oil to ease installation. Line up the shaft assembly so the oil-drain slot in the bearing housing is facing down and slide the shaft assembly into the power-frame as far as it will go by hand. Check to be sure the assembly is going in straight. Lightly tap the key-way end of the shaft to assure the shaft is in its forward most position. Be careful not to pinch the bearing housing o-ring seal (Item 33B) on the power-frame, or damage the o-ring in the labyrinth oil seal.
- 13) Install the adjusting screws (Item 33A). If screws are of different length, the longer screws thread into the power-frame.
- 14) Install the inboard lip type oil seal, if required (Item 47) into the power-frame. First ensure that the bore and shaft diameter are clean and free of scratches or grooves. Lubricate the ID of the seal and place sealant around the OD of the seal. Carefully place the oil-seal over the shaft watching out for sharp edges such as on impeller threads and place up against the bore. Then

seat the oil-seal in place with a softfaced tool applying force evenly around the outer edge to avoid cocking the seal. Wipe off any excess sealant.

- 15) Install the deflector (Item 40), if bearing frame is provided with lip type oil seals, by sliding on the shaft.
- 16) Install sight-glass, breather and plugs (Items 19A, 19B, 19C, 19G and 19H) in their respective locations.
- 17) If separate, install the frame-leg (Item 19E) and secure with frame-leg screws (Item 19F), torque to 25 ft-lbs.
- 18) If separate, install the bearing frame adapter (Item 71). Ensure that the adapter is seated squarely on the power-frame before tightening adapter screws, this may require some sanding of the paint on the pilot diameters. Secure with adapter screws (Item 71A), torque to 25 ft-lbs.
- 19) Install the casing jack-screws (Item 19D), ensure that the screws do not extend past the cast iron cover adapter, as damage could result to the pump.

CAUTION: Prior to starting the pump, re-lubricate the bearing frame.

PUMP END ASSEMBLY

- 1) Inspect casing, cover and impeller for any damage and make sure all sealing surfaces are free of dirt and scratches. If pump is equipped with an internal seal flush, make sure cover flush hole is clear.
- 2) Use the adjusting screws (Item 33A) to adjust the bearing housing (Item 33) to its forward most position and then lightly coat the shaft threads with an anti-seize compound.
- 3) The Fybroc pump, as standard, is equipped with a single outside seal with stationary seal face and rotating compression unit, or a double inside seal with stationary seal faces and rotating double seal compression unit. The following installation instructions are based on these seal types. When other types of seals are used, please refer to the manufacturer's installation data. Determine the type of seal being used and refer to the following sections.

SINGLE OUTSIDE SEAL INSTALLATION JOHN CRANE TYPE 8B2

- 1) Remove the mechanical seal from its packaging, inspect for any damage, and keep seal faces clean and free from contaminants during installation. **DO NOT GREASE OR LUBRICATE SEAL FACES.**
- 2) Install the inboard stationary seal gasket and the stationary seal insert into their bores on the pump cover. Then place the outboard stationary gasket over the stationary insert. Next place the seal gland over the stationary insert and gaskets, making sure that all the gaskets have been installed properly before

ASSEMBLY/DISASSEMBLY PROCEDURES FOR HORIZONTAL PUMPS

securing the gland bolts. Be sure that the gland pilot is properly engaged, and draw up the gland bolts evenly, cross staggering adjustment of the bolts. Proper gland bolt adjustment is especially important where clamp style inserts are used. The gland bolts should be torqued to a maximum of 10 Ft/Lbs.

- 3) Lightly coat the impeller sleeve with a suitable lubricant. Carefully slide impeller sleeve through the cover, being careful not to chip the stationary sealing face.
- 3A) For separate shaft sleeve installation, position the cover over the impeller and insert the sleeve through the mechanical seal stationary insert until the hooked end of the sleeve rests on the impeller hub.
- 4) Lubricate the rotary unit o-ring with a suitable lubricant. Then engage the rotary assembly over the impeller sleeve. Use a slight twisting motion as the rotary unit is slid down the impeller sleeve until it touches the stationary sealing face. Do not tighten set screws or remove setting clips.
- 5) Mount the impeller, cover and seal assembly onto the power-frame, making sure the impeller threads are firmly bottomed on the shaft threads.
- 5A) For separate shaft sleeve installation, slide the sleeve and seal assembly over the shaft until the hooked end of the sleeve bottoms on the shaft shoulder. Install and clamp cover in position. Insert impeller o-ring (Item 2B) in the groove on the impeller hub and thread impeller onto shaft insuring impeller hub, sleeve hook and shaft shoulder are firmly bottomed.
- 6) At this stage check to be sure the impeller threads are properly seated on the shaft threads. There should be clearance between the cover face and the back of the impeller. If there is no clearance, adjust the shaft forward with the adjusting screws (Item 33A) and reseal the impeller. (See impeller adjustment section.)
- 7) With the impeller threads firmly seated, adjust the impeller towards the cover (see impeller adjustment section) until the back of the impeller just touches the cover face.
- 8) Install the cover o-ring (Item 73) and casing. Adjust the axial impeller clearance to the specified value in the impeller adjustment section.
- 9) Slide the seal rotary unit until it touches the seal stationary face with a slight twisting motion. Tighten the rotary set screws and remove the assembly clips. No further seal adjustment is necessary.
- 10) Make appropriate piping connections to the seal assembly.

DOUBLE SEAL INSTALLATION JOHN CRANE TYPE 8-1T

- 1) Remove the mechanical seal from its packaging, inspect for any damage, keep seal faces clean and free from contaminants during installation. **DO NOT GREASE OR LUBRICATE SEAL FACES.**
- 2) Lightly lubricate the inboard stationary insert o-ring and cover bore with a suitable lubricant and then install the inboard stationary insert into the pump cover bore.
- 3) Lightly lubricate the outboard stationary, insert o-ring and gland bore, and install the outboard stationary into the gland bore.
- 4) Lightly coat the impeller sleeve with a suitable lubricant. Carefully slide impeller sleeve through the cover, being careful not to chip the stationary sealing face.
- 4A) For separate shaft sleeve installation, position the cover over the impeller and insert the sleeve through the mechanical seal stationary insert until the hooked end of the sleeve rests on the impeller hub.
- 5) Lubricate the rotary unit o-rings with a suitable lubricant. Then engage the rotary assembly over the impeller sleeve. Use a slight twisting motion as the rotary unit is slid down the impeller sleeve until it touches the stationary sealing face. Do not tighten set screws.
- 6) Install the gland o-ring into its groove on the gland. Then place the gland over the rotating seal assembly, making sure the gland o-ring is in place before securing the gland bolts. Be sure that the gland pilot is properly engaged, and draw up the gland bolts evenly, cross staggering adjustment of the bolts. The gland bolts should be torqued to a maximum of 10 Ft/Lbs.
- 7) Mount the impeller, cover and seal assembly onto the power-frame, making sure the impeller threads are firmly bottomed on the shaft threads.
- 7A) For separate shaft sleeve installation, slide the sleeve, gland and cover assembly over the shaft until the hooked end of the sleeve bottoms on the shaft shoulder. Clamp cover in position. Insert impeller o-ring (Item 2B) in the groove on the impeller hub and thread impeller onto shaft insuring impeller hub, sleeve hook, and shaft shoulder are firmly bottomed.
- 8) At this stage check to be sure the impeller threads are properly seated on the shaft threads. There should be clearance between the cover face and the back of the impeller. If there is no clearance, adjust the shaft forward with the adjusting screws (Item 33A) and reseal the impeller. (See impeller adjustment section)
- 9) With the impeller threads firmly seated, adjust the impeller towards the cover (see impeller adjustment section) until the back of the impeller just touches the cover face.

ASSEMBLY/DISASSEMBLY PROCEDURES FOR HORIZONTAL PUMPS

- 10) Install the cover o-ring (Item 73) and casing. Adjust the axial impeller clearance to the specified value in the impeller adjustment section.
- 11) Remove the pipe plug in the bottom of the gland. Center the set screws of the seal rotary unit in the pipe plug hole and tighten. Replace pipe plug and make appropriate piping connections to the seal assembly.

DOUBLE SEAL INSTALLATION JOHN CRANE TYPE 8-D

- 1) Remove the mechanical seal from its packaging, inspect for any damage, keep seal faces clean and free from contaminants during installation. **DO NOT GREASE OR LUBRICATE SEAL FACES.**
- 2) Lightly lubricate the inboard stationary insert o-ring and cover bore and install the inboard stationary insert into the pump cover bore.
- 3) Lightly lubricate the outboard stationary insert o-ring and gland bore and install the outboard stationary insert into the gland bore.
- 4) Lightly coat the impeller sleeve with a suitable lubricant. Carefully slide impeller sleeve through the cover, being careful not to chip the stationary sealing face.

NOTE: The John Crane 8-D is a friction drive type of seal, the impeller sleeve and rotary unit should be lubricated with a soapy water solution to ease installation without reducing the frictional drive of the rotary unit.

- 4A) For separate shaft sleeve installation, position the cover over the impeller and insert the sleeve through the mechanical seal stationary insert until the hooked end of the sleeve rests on the impeller hub.
- 5) Lubricate the rotary unit o-rings with a suitable lubricant. Then engage the rotary assembly over the impeller sleeve. Use a slight twisting motion as the rotary unit is slid down the impeller sleeve until it touches the stationary sealing face.
- 6) Install the gland o-ring into its groove on the gland. Then place the gland over the rotating seal assembly, making sure the gland o-ring is in place before securing the gland bolts. Be sure that the gland pilot is properly engaged, and draw up the gland bolts evenly, cross staggering adjustment of the bolts. The gland bolts should be torqued to a maximum of 10 Ft/Lbs.
- 7) Mount the impeller, cover and seal assembly onto the power-frame, making sure the impeller threads are firmly bottomed on the shaft threads.
- 7A) For separate shaft sleeve installation, slide the sleeve, gland, and cover assembly over the shaft until the hooked end of the sleeve bottoms on the shaft

- shoulder. Clamp cover in position. Insert impeller o-ring (Item 2B) in the groove on the impeller hub and thread impeller onto shaft insuring impeller hub, sleeve hook, and shaft shoulder are firmly bottomed.
- 8) At this stage check to be sure the impeller threads are properly seated on the shaft threads. There should be clearance between the cover face and the back of the impeller. If there is no clearance, adjust the shaft forward with the adjusting screws (Item 33A) and reseal the impeller. (See impeller adjustment section)
- 9) With the impeller threads firmly seated, adjust the impeller towards the cover (see impeller adjustment section) until the back of the impeller just touches the cover face.
- 10) Install the cover o-ring (Item 73) and casing. Adjust the axial impeller clearance to the specified value in the impeller adjustment section.
- 11) The 8-D seal is self centering and requires no adjustment. Make appropriate piping connections to the seal assembly.

PACKED STUFFING BOX

- 1) Install the four gland studs into the cover and tighten to 10 ft-lbs.
- 2) Install o-ring in stuffing box extension. Place over gland studs and check that the stuffing box extension is seated properly. Secure to cover with gland nuts and washers, tighten to 10 ft-lbs.
- 3) Place metallic shaft sleeve in cover bore, and install two packing rings into the stuffing box extension. Install the lantern ring followed by remaining three packing rings.
- 4) Check to make sure lantern ring is lined up with flush hole. Damage could result to packing and shaft sleeve if flush water is restricted.
- 5) Install gland ring over gland studs and secure with gland nuts and washers. Hand-tighten the nuts for now. The nuts need to be adjusted when the pump is started up.
- 6) Mount the cover assembly and sleeve onto the power-frame.
- 7) Clamp the cover in position and slide the shaft sleeve towards the bearing frame until it bottoms on the shaft shoulder. Insert impeller o-ring in the groove on the impeller hub and thread impeller onto shaft insuring impeller hub, sleeve and shaft shoulder are firmly bottomed.
- 8) At this stage check to be sure the impeller threads are properly seated on the shaft threads. There should be clearance between the cover face and the back of the impeller. If there is no clearance, adjust the shaft

ASSEMBLY/DISASSEMBLY PROCEDURES FOR HORIZONTAL PUMPS

forward with the adjusting screws (Item 33A) and reseat the impeller. (See impeller adjustment section).

- 9) With the impeller threads firmly seated, adjust the impeller towards the cover (see impeller adjustment section) until the back of the impeller just touches the cover face.
- 10) Install the cover o-ring (Item 73) and casing. Adjust the axial impeller clearance to the specified value in the impeller adjustment section.
- 11) Make appropriate flush piping connections to the 15 stuffing box extension.

IMPELLER ADJUSTMENT

The horizontal 1500 series design permits adjustment of the impeller clearance between the pump casing wall and the impeller face. The pump impeller is adjusted at the factory during assembly and should not require further adjustment upon installation.

Impeller adjustment will be required when a drop in head and/or capacity indicates a change in clearance, or when existing components of the pump are replaced. Refer to the following table for recommended clearance when adjusting impeller on horizontal pumps.

| Impeller Diameter | Clearance |
|-------------------|----------------|
| Up to 8' | .015" (.38 mm) |
| 8' to 10' | .020" (.50 mm) |
| 10' to 16' | .025" (.64 mm) |

Loosen set screws or other holding devices if so provided on mechanical seals before adjusting impeller to prevent seal face damage.

- A) Loosen the adjusting screws (Item 33A) evenly.
- B) Tighten up equally on the screws that thread into the power-frame until you can feel the impeller just starting to rub on the casing face. By rotating the shaft frequently by hand while taking up on the screws, you can determine when the impeller begins to bind.
- C) Back out the screws that thread into the powerframe until you can insert a feeler gauge under each of the bolt heads to the recommended clearance (See table above).
- D) Tighten the remaining adjusting jacking screws until the gap left by the feeler gauge is gone.
- E) Check to be sure the shaft turns freely.
- F) Reset and tighten the mechanical seal per the seal manufacturers instructions.

NOTE: Frequent impeller adjustments to restore hydraulic performance are an indication of increased internal clearances. Excessive clearance behind the impeller will result in excessive thrust loads in high pressure pumps leading to reduced outboard bearing life. Replace worn parts.

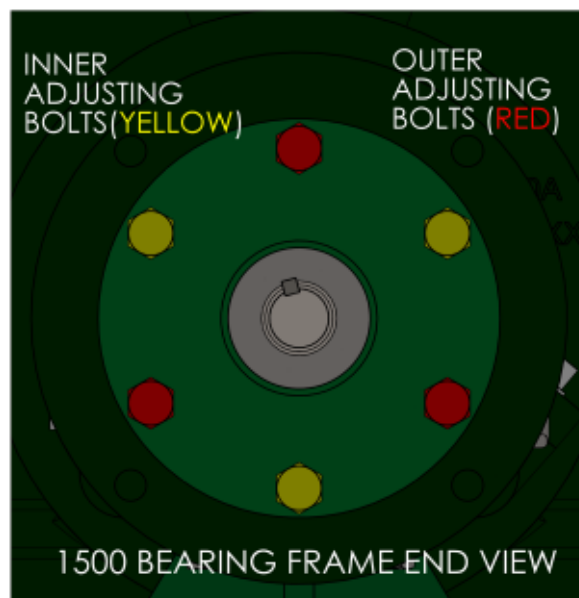
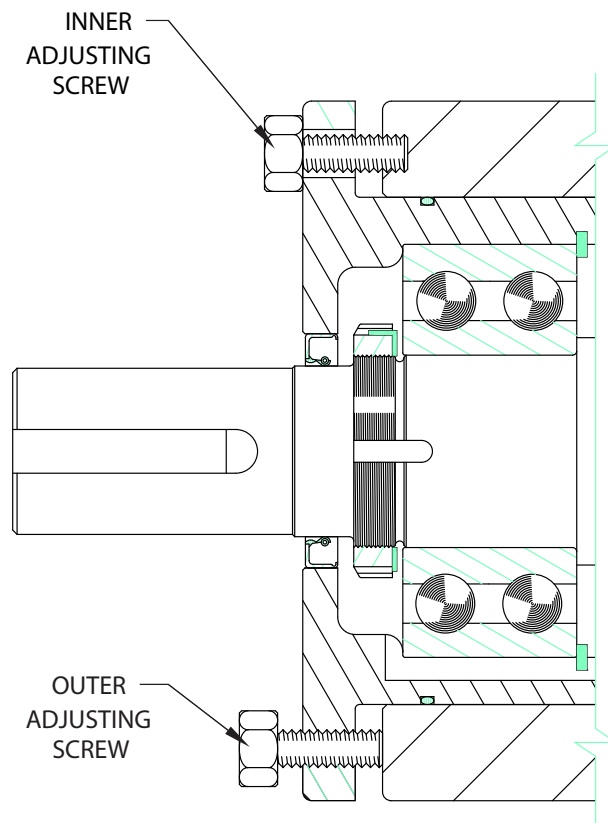

INNER ADJUSTING BOLTS SHOULD LINE UP WITH THREADED HOLES IN BEARING FRAME

INSTALLATION INSTRUCTIONS/FLEX-TYPE COUPLINGS



WARNING: DO NOT PROCEED WITH THE COUPLING INSTALLATION UNTIL THE DIRECTION OF MOTOR ROTATION HAS BEEN ESTABLISHED TO BE CORRECT. FAILURE TO DO SO MAY RESULT IN DAMAGE TO THE PUMP.

- 1) Inspect all coupling components and remove any protective coatings or lubricants from bores, mating surfaces and fasteners. Remove any existing burrs, etc. from the shafts.
- 2) Place four cap-screws with lock-washers through the holes in each spacer hub. Slide one spacer hub onto each shaft, using snug-fitting keys.
- 3) If using a two-piece sleeve, assemble the two halves together and hang the wire ring loosely in the groove next to the teeth.
- 4) Position the sleeve between the two flanges. Be certain that the teeth on the sleeve are fully seated in each flange.
- 5) Place this assembly between the spacer hubs. Align the tapped holes in the flange with the cap-screws in one of the hubs. Hand tighten these four cap-screws and visually inspect the gap between the hub and the flange to ensure that the flange is seated properly. Tighten the four cap-screws to their designated torque values, see table below.
- 6) Rotate the other shaft until the cap-screws on the other hub can be started into the tapped holes of the loose flange. Hand tighten these four cap-screws and visually inspect the gap between the hub and the flange to ensure that the flange is seated properly. Tighten the four cap-screws to their designated torque values, see table below.
- 7) Check to be certain that the sleeve is still fully engaged in both flanges. Then slide the coupling assembly so that there is an equal length of shaft extending into each flange. Check that the shaft keys

are fully engaged between the shaft and the hub before tightening the setscrews on both hubs. See the following table for torque values.

- 8) {Photo} Check parallel alignment by placing a straightedge across the two coupling flanges and measuring the maximum offset at various points around the periphery of the coupling without rotating the coupling. If the maximum offset exceeds the figure shown under "Parallel" in the following table, realign the shafts.
 - 9) {Photo} Check angular alignment with a micrometer or caliper. Measure from the outside of one flange to the outside of the other at intervals around the periphery of the coupling. Determine the maximum and minimum dimensions without rotating the coupling. The difference between the maximum and minimum must not exceed the figure given under "Angular" in the following table. If a correction is necessary, be sure to recheck the parallel alignment.
- NOTE: KEEPING COUPLING MISALIGNMENT VALUES AS CLOSE TO ZERO AS POSSIBLE WILL EXTEND COUPLING LIFE AND REDUCE VIBRATION LEVELS. INSTALLATION INSTRUCTIONS/FLEX-TYPE COUPLINGS**

| TORQUE VALUES TYPE SC COUPLINGS | | | | |
|---------------------------------|------------|-------|------------|-------|
| Coupling Hub Size | Cap-Screws | | Set-Screws | |
| | (ft-lbs) | (N-m) | (ft-lbs) | (N-m) |
| 3 | - | - | - | - |
| 4 | 5.5 | 7.5 | 13 | 17.6 |
| 5 | 4 | 5.4 | 13 | 17.6 |
| 6 | 9 | 12.2 | 13 | 17.6 |
| 7 | 9 | 12.2 | 13 | 17.6 |
| 8 | 18 | 24.4 | 23 | 31.2 |
| 9 | 31 | 42.0 | 23 | 31.2 |
| 10 | 50 | 67.8 | 50 | 67.8 |
| 11 | 75 | 101.7 | 50 | 67.8 |
| 12 | 150 | 203.4 | 100 | 135.6 |
| 13 | 150 | 203.4 | 165 | 223.7 |
| 14 | 150 | 203.4 | 165 | 223.7 |
| 16 | 150 | 203.4 | 165 | 223.7 |

| MAXIMUM ALLOWABLE MISALIGNMENT | | | | | | | |
|--------------------------------|-------|--------------|---------|------------|---------|----------|---------|
| Sleeve Size | Units | Type JE & JN | | Type E & N | | Type H | |
| | | Parallel | Angular | Parallel | Angular | Parallel | Angular |
| 3 | inch | 0.01 | 0.035 | - | - | - | - |
| | mm | 0.254 | 0.889 | - | - | - | - |
| 4 | inch | 0.01 | 0.043 | - | - | - | - |
| | mm | 0.254 | 1.092 | - | - | - | - |
| 5 | inch | 0.015 | 0.056 | 0.015 | 0.056 | - | - |
| | mm | 0.381 | 1.422 | 0.381 | 1.422 | - | - |
| 6 | inch | 0.015 | 0.07 | 0.015 | 0.07 | 0.01 | 0.016 |
| | mm | 0.381 | 1.778 | 0.381 | 1.778 | 0.254 | 0.406 |
| 7 | inch | 0.02 | 0.081 | 0.02 | 0.081 | 0.012 | 0.02 |
| | mm | 0.508 | 2.057 | 0.508 | 2.057 | 0.305 | 0.508 |
| 8 | inch | 0.02 | 0.094 | 0.02 | 0.094 | 0.015 | 0.025 |
| | mm | 0.508 | 2.388 | 0.508 | 2.388 | 0.381 | 0.635 |
| 9 | inch | - | - | 0.025 | 0.109 | 0.017 | 0.028 |
| | mm | - | - | 0.635 | 2.769 | 0.432 | 0.711 |
| 10 | inch | - | - | 0.025 | 0.128 | 0.02 | 0.032 |
| | mm | - | - | 0.635 | 3.251 | 0.508 | 0.813 |
| 11 | inch | - | - | 0.032 | 0.151 | 0.022 | 0.037 |
| | mm | - | - | 0.813 | 3.835 | 0.559 | 0.940 |
| 12 | inch | - | - | 0.032 | 0.175 | 0.025 | 0.042 |
| | mm | - | - | 0.813 | 4.445 | 0.635 | 1.067 |
| 13 | inch | - | - | 0.04 | 0.195 | - | - |
| | mm | - | - | 1.016 | 4.953 | - | - |
| 14 | inch | - | - | 0.045 | 0.242 | - | - |
| | mm | - | - | 1.143 | 6.147 | - | - |
| 16 | inch | - | - | 0.062 | 0.33 | - | - |
| | mm | - | - | 1.575 | 8.382 | - | - |

INSTALLATION INSTRUCTIONS/FLEX-TYPE COUPLINGS

- 10) If the coupling employs a two-piece sleeve with the wire ring, force the ring into its groove in the center of the sleeve. It may be necessary to pry the ring into position with a blunt screwdriver.
- 11) Install the coupling guard over the coupling assembly and finger tighten the coupling guard cap-screws. Check for any contact between the guard and the rotating assembly. Then tighten the coupling guard bolts to the torque values given on the side of the baseplate.



WARNING: DO NOT OPERATE THE PUMP WITHOUT THE COUPLING GUARD INSTALLED PROPERLY AS COUPLING SLEEVES CAN BE THROWN FROM THE COUPLING ASSEMBLY WITH SUBSTANTIAL FORCE IF THE COUPLING IS SUBJECTED TO A SEVERE SHOCK LOAD.

- 12) To remove the sleeve for inspection or replacement, remove the eight cap-screws from the spacer hubs. Then loosen the hub set-screws and slide the hubs back and drop the sleeve and flange assembly out.



WARNING: NEVER REPLACE A HYTREL SLEEVE WITH A RUBBER SLEEVE AS THESE SLEEVES HAVE COMPLETELY DIFFERENT RATINGS AND INTERCHANGING THEM CAUSE DAMAGE TO THE EQUIPMENT.

OPERATIONAL START-UP CHECKLIST

SERIES 1500 HORIZONTAL PUMPS

- Foundation level and baseplate grouted.
- Foundation bolts tight.
- Coupling aligned without sleeve.
- Motor and pump mounting bolts tight.
- Suction and discharge connections secure.
- Flush piping installed if required.
- Electrical connections secure and covered.
- Lubricate power-frame as required.
- Ensure that coupling sleeve is not installed.
- Jog motor/Check rotation.
- Turn pump shaft by hand, ensure that it does not bind.
- Check shaft alignment and install coupling sleeve.
- Ensure that all guards are in place.
- Ensure seal is properly flushed.
- Suction valve is open, Discharge valve is slightly open.
- Ensure that pump is primed.
- Start pump and open discharge valve to desired flow rate.
- Check flush water flow and pressure.
- Check oil level if so equipped.
- Check for excessive vibration and oil temperature.
- Check packing for leakage and mechanical seal for no leaks after run-in.

1500 SERIES GROUP 1

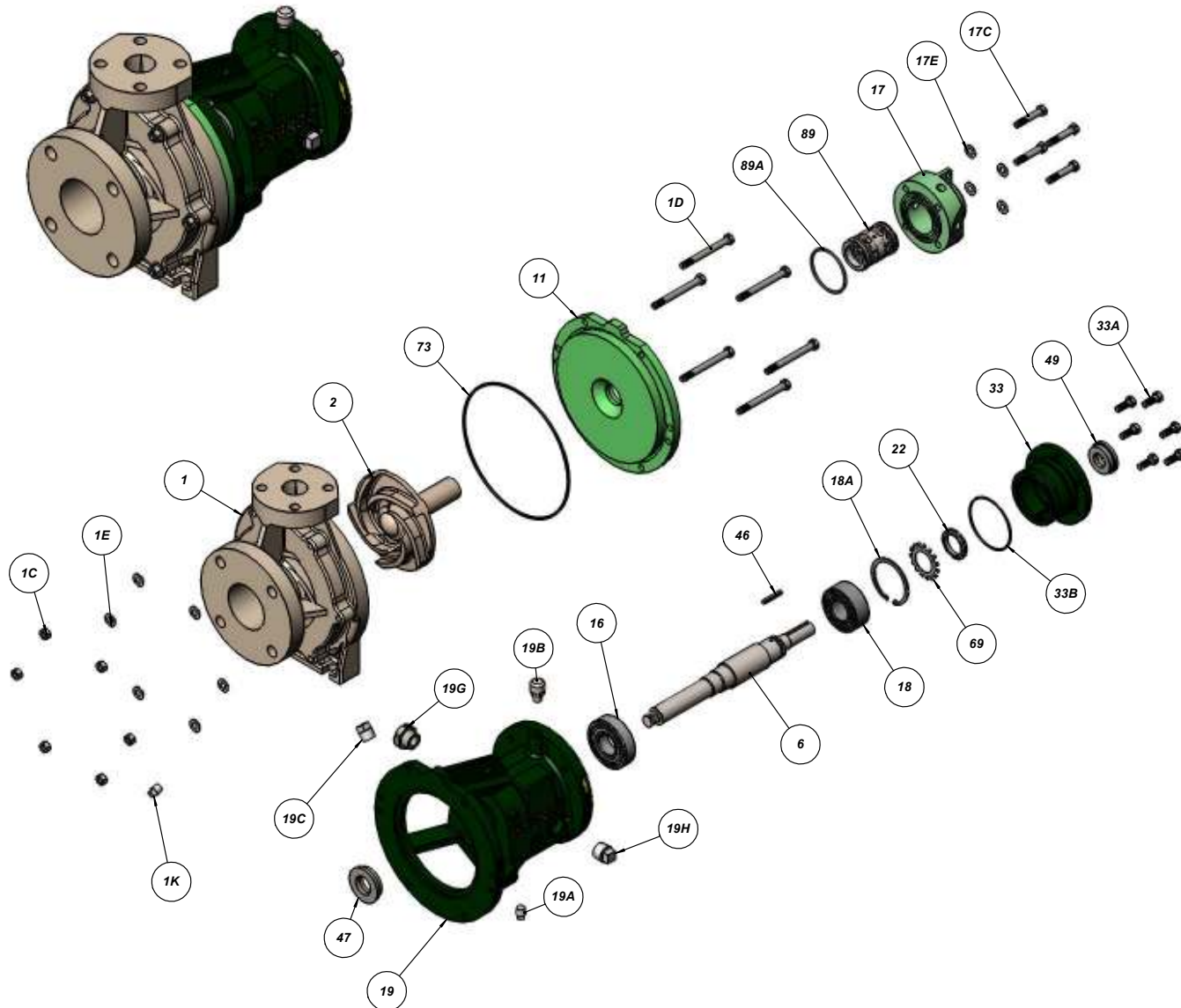

| ITEM# | DESCRIPTION | QTY. | MATERIAL |
|-------|----------------------|------|----------------|
| 1 | CASING | 1 | VINYL ESTER |
| 1C | CASING NUT | 6 | 303 S.S. |
| 1D | CASING BOLT | 6 | 303 S.S. |
| 1E | CASING WASHER | 6 | 303 S.S. |
| 1K | DRAIN PLUG (opt.) | 1 | TEFLON |
| 2 | IMPELLER | 1 | VINYL ESTER |
| 6 | SHAFT | 1 | 303 S.S. |
| 11 | COVER | 1 | VINYL ESTER |
| 16 | BEARING INBOARD | 1 | STEEL |
| 17 | GLAND | 1 | VINYL ESTER |
| 17C | GLAND BOLT | 4 | 303 S.S. |
| 17E | GLAND WASHER | 4 | 303 S.S. |
| 18 | BEARING OUTBOARD | 1 | STEEL |
| 18A | SNAP RING | 1 | STEEL |
| 19 | FRAME | 1 | CAST IRON |
| 19A | OIL DRAIN PLUG | 1 | STEEL |
| 19B | BREATHER | 1 | STEEL |
| 19C | OIL FILL PLUG | 1 | STEEL |
| 19G | SIGHT GLASS | 1 | STEEL/GLASS |
| 19H | SIGHT GLASS PLUG | 1 | STEEL |
| 22 | BEARING LOCKNUT | 1 | STEEL |
| 33 | BEARING HOUSING | 1 | CAST IRON |
| 33A | ADJUSTING SCREW | 6 | 303 S.S. |
| 33B | O-RING, BRG. HOUSING | 1 | BUNA |
| 46 | COUPLING KEY | 1 | 303 S.S. |
| 47 | LABY. SEAL INBRDRG. | 1 | BRZ/NICKEL PL. |
| 49 | LABY. SEAL OUTBRD. | 1 | BRZ/NICKEL PL. |
| 69 | LOCKWASHER | 1 | STEEL |
| 73 | O-RING COVER | 1 | VITON |
| 89 | DBL. MECHANICAL SEAL | 1 | CARBON/CERAMIC |
| 89A | GLAND SEAL, COVER | 1 | VITON |

These drawing & specification are the property of Global Pump Solution. Fybroc, Product Brand, Served, P.O. and logo may not be reproduced or copied or used as the basis for the manufacture of the apparatus without permission.

| | | | |
|---|---------------|----------------|----------|
| Fybroc A CECO Environmental Brand | | | |
| MODEL | 1500 - GRP. 1 | SCALE | DRAWN BY |
| SIZE | 1.5X3X6 | 1/2, 5/8 | ELT |
| EXPLODED VIEW DRAWING | | | |
| INTEGRAL SLEEVE; 8T MECHANICAL SEAL | | | |
| TOLERANCE FOR ALL DIMENSIONS UNLESS OTHERWISE SPECIFIED | DATE | DRAWING NUMBER | REV. |
| | 07/23/13 | D53001_2 | |

1500 SERIES GROUP 2

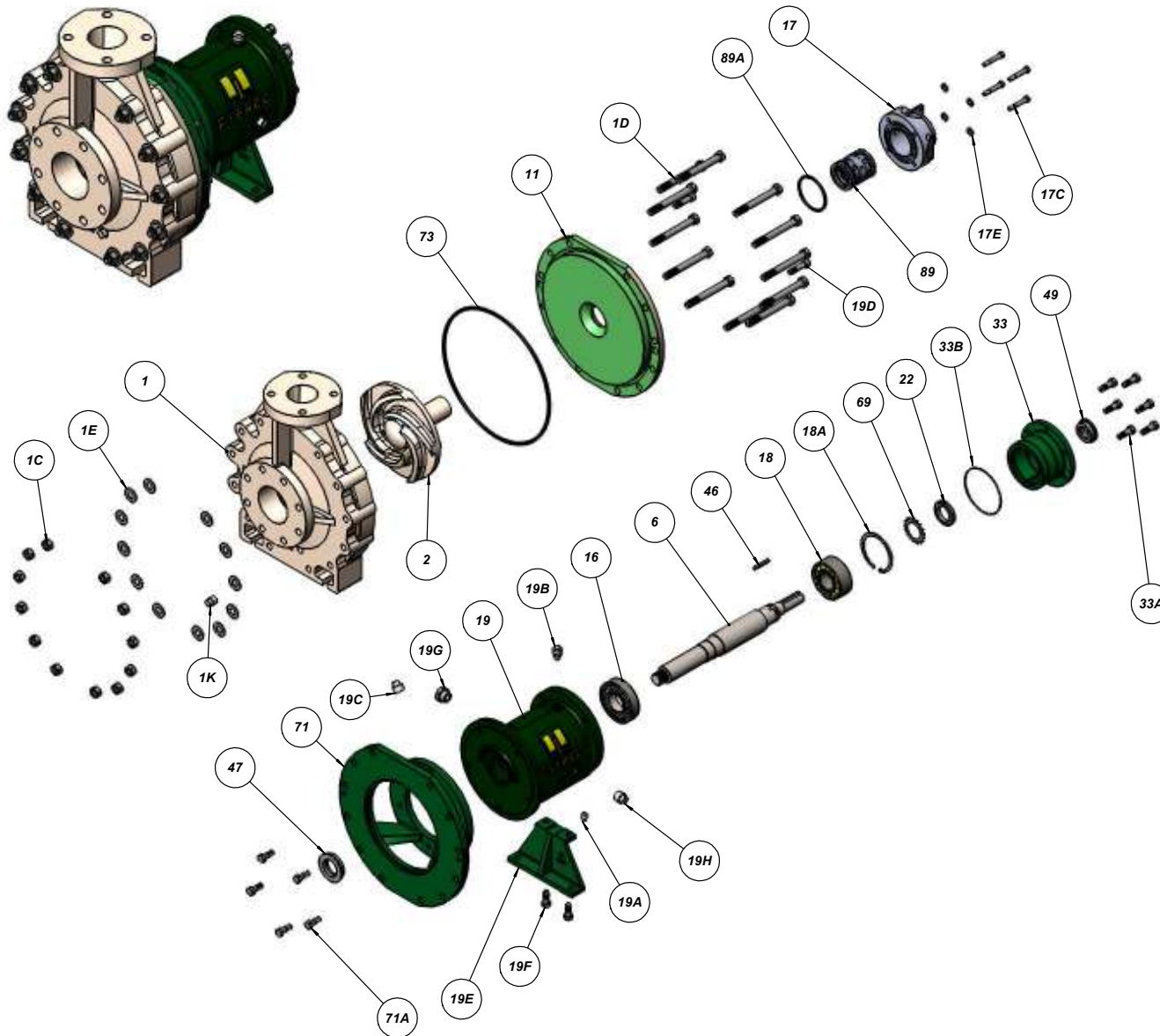

| ITEM# | DESCRIPTION | QTY. | MATERIAL |
|-------|-----------------------|------|----------------|
| 1 | CASING | 1 | VINYL ESTER |
| 1C | CASING NUT | 12 | 303 S.S. |
| 1D | CASING BOLT | 12 | 303 S.S. |
| 1E | CASING WASHER | 12 | 303 S.S. |
| 1K | CASING DRAIN | 1 | TEFLON |
| 2 | IMPELLER | 1 | VINYL ESTER |
| 6 | SHAFT | 1 | 303 S.S. |
| 11 | COVER | 1 | VINYL ESTER |
| 16 | BEARING INBOARD | 1 | STEEL |
| 17 | GLAND | 1 | VINYL ESTER |
| 17C | GLAND BOLT | 4 | 303 S.S. |
| 17E | GLAND WASHER | 4 | 303 S.S. |
| 18 | BEARING OUTBOARD | 1 | STEEL |
| 18A | SNAP RING | 1 | STEEL |
| 19 | FRAME | 1 | CAST IRON |
| 19A | OIL DRAIN PLUG | 1 | STEEL |
| 19B | BREATHER | 1 | STEEL |
| 19C | OIL FILL PLUG | 1 | STEEL |
| 19D | JACK SCREW | 2 | 303 S.S. |
| 19E | FRAME LEG | 1 | CAST IRON |
| 19F | FRAME LEG SCREW | 2 | 303 S.S. |
| 19G | SIGHT GLASS | 1 | STEEL/GLASS |
| 19H | SIGHT GLASS PLUG | 1 | STEEL |
| 22 | BEARING LOCKNUT | 1 | STEEL |
| 33 | BEARING HOUSING | 1 | CAST IRON |
| 33A | ADJUSTING SCREW | 6 | 303 S.S. |
| 33B | O-RING, BRG. HOUSING | 1 | BUNA |
| 46 | COUPLING KEY | 1 | 303 S.S. |
| 47 | LABY. SEAL INBRDRG. | 1 | BRZ/NICKEL PL. |
| 49 | LABY. SEAL OUTBRD. | 1 | BRZ/NICKEL PL. |
| 69 | LOCKWASHER | 1 | STEEL |
| 71 | BEARING FRAME ADAPTOR | 1 | CAST IRON |
| 71A | ADAPTOR SCREW | 5 | 303 S.S. |
| 73 | O-RING COVER | 1 | VITON |
| 89 | DBL. MECHANICAL SEAL | 1 | CARBON/CERAMIC |
| 89A | GLAND SEAL, COVER | 1 | VITON |

Fybroc
A CECO Environmental Brand

These drawings & specifications are the property of Global Pump Solution. Fybroc, Product Brand, Teflon, Pt. and Incol are trademarks of the manufacturer of the respective material without permission.

| | | | |
|---|------------|------------|----------|
| MODEL | 1500 GRP 2 | DRAWN BY | ELT |
| | 3x4x10 | CHECKED BY | |
| DATE | 08/12/13 | REVISION | D53010_2 |
| EXPLODED VIEW DRAWING INTEGRAL SLEEVE, BIT MECHANICAL SEAL | | | |

1500 SERIES GROUP 3

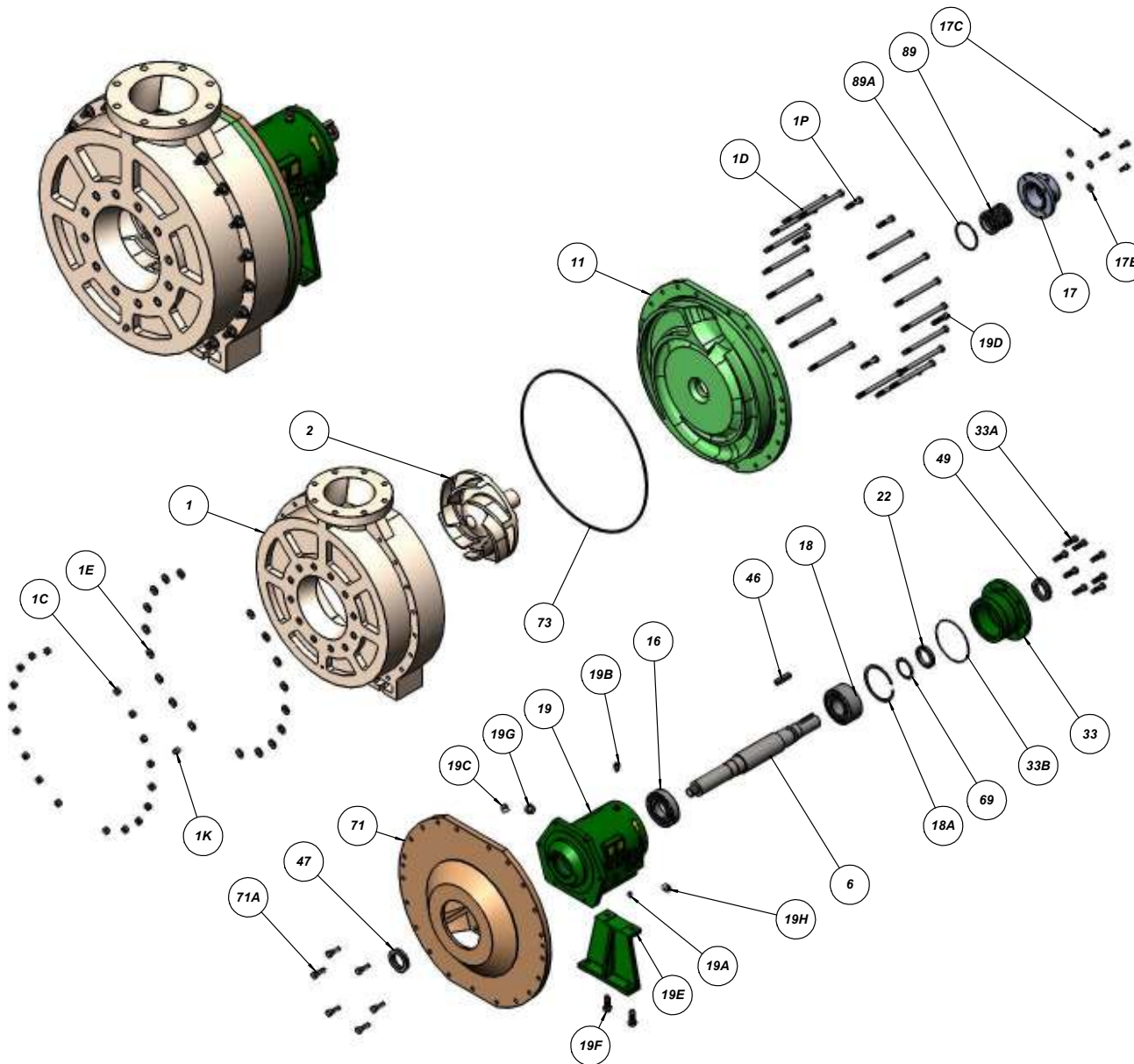

| ITEM# | DESCRIPTION | QTY. | MATERIAL |
|-------|-----------------------|------|----------------|
| 1 | CASING | 1 | VINYL ESTER |
| 1C | CASING NUT | 18 | 303 S.S. |
| 1D | CASING BOLT | 18 | 303 S.S. |
| 1E | CASING WASHER | 18 | 303 S.S. |
| 1K | DRAIN PLUG (opt.) | 1 | TEFLON |
| 1P | CASING BOLT | 3 | 303 S.S. |
| 2 | IMPELLER | 1 | VINYL ESTER |
| 6 | SHAFT | 1 | 303 S.S. |
| 11 | COVER | 1 | VINYL ESTER |
| 16 | BEARING INBOARD | 1 | STEEL |
| 17 | GLAND | 1 | VINYL ESTER |
| 17C | GLAND BOLT | 4 | 303 S.S. |
| 17E | GLAND WASHER | 4 | 303 S.S. |
| 18 | BEARING OUTBOARD | 1 | STEEL |
| 18A | SNAP RING | 1 | STEEL |
| 19 | FRAME | 1 | CAST IRON |
| 19A | OIL DRAIN PLUG | 1 | STEEL |
| 19B | BREATHER | 1 | STEEL |
| 19C | OIL FILL PLUG | 1 | STEEL |
| 19D | JACK SCREW | 2 | 303 S.S. |
| 19E | FRAME LEG | 1 | CAST IRON |
| 19F | FRAME LEG SCREW | 2 | 303 S.S. |
| 19G | SIGHT GLASS | 1 | STEEL/GLASS |
| 19H | SIGHT GLASS PLUG | 1 | STEEL |
| 22 | BEARING LOCKNUT | 1 | STEEL |
| 33 | BEARING HOUSING | 1 | CAST IRON |
| 33A | ADJUSTING SCREW | 8 | 303 S.S. |
| 33B | O-RING, BRG. HOUSING | 1 | BUNA |
| 46 | COUPLING KEY | 1 | 303 S.S. |
| 47 | LABY. SEAL INBRDRG. | 1 | BRZ/NICKEL PL. |
| 49 | LABY. SEAL OUTBRD. | 1 | BRZ/NICKEL PL. |
| 69 | LOCKWASHER | 1 | STEEL |
| 71 | BEARING FRAME ADAPTOR | 1 | CAST IRON |
| 71A | ADAPTOR SCREW | 6 | 303 S.S. |
| 73 | O-RING COVER | 1 | VITON |
| 89 | DBL. MECHANICAL SEAL | 1 | CARBON/CERAMIC |
| 89A | GLAND SEAL, COVER | 1 | VITON |

These drawing & specification are the property of CECO Pump Solution, Fybroc Product Brand, Bedford, Pa. and shall not be reproduced or copied or used as the basis for the manufacture of the apparatus without permission.

Fybroc
A CECO Environmental Brand

| | | | | | |
|--------------------------------------|------------|------------|------|----------|----------|
| MODEL | 1500 GRP 3 | SCALE | 1/8" | DRAWN BY | ELT |
| SIZE | 8x10x15 | CHECKED BY | | | |
| EXPLODED VIEW DRAWING | | | | | |
| INTEGRAL SLEEVE: 81T MECHANICAL SEAL | | | | | |
| DATE | 09/04/13 | ISSUE NO. | | DWG NO. | D53017_2 |

1500 SERIES SEAL AND STUFFING BOX ARRANGEMENTS

PRODUCT FLUSH:

A portion of the pumped fluid is re-circulated through the stuffing box to provide lubrication and cooling to the seal. Use plastic fittings only.

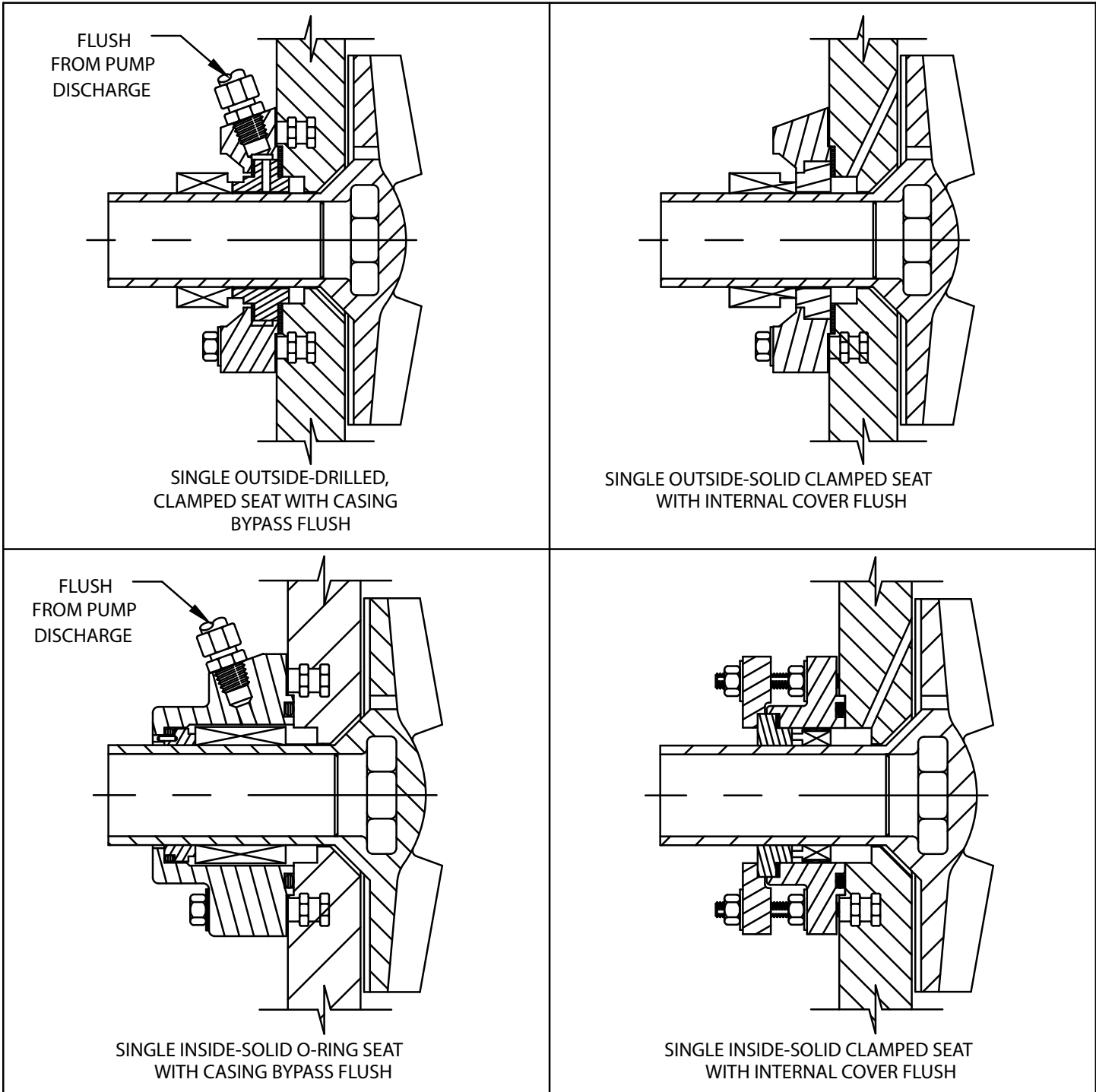

1500 SERIES SEAL AND STUFFING BOX ARRANGEMENTS

EXTERNAL FLUSH:

An external source of clean fluid is required at the stuffing box to provide lubrication and cooling. Use plastic fittings only.

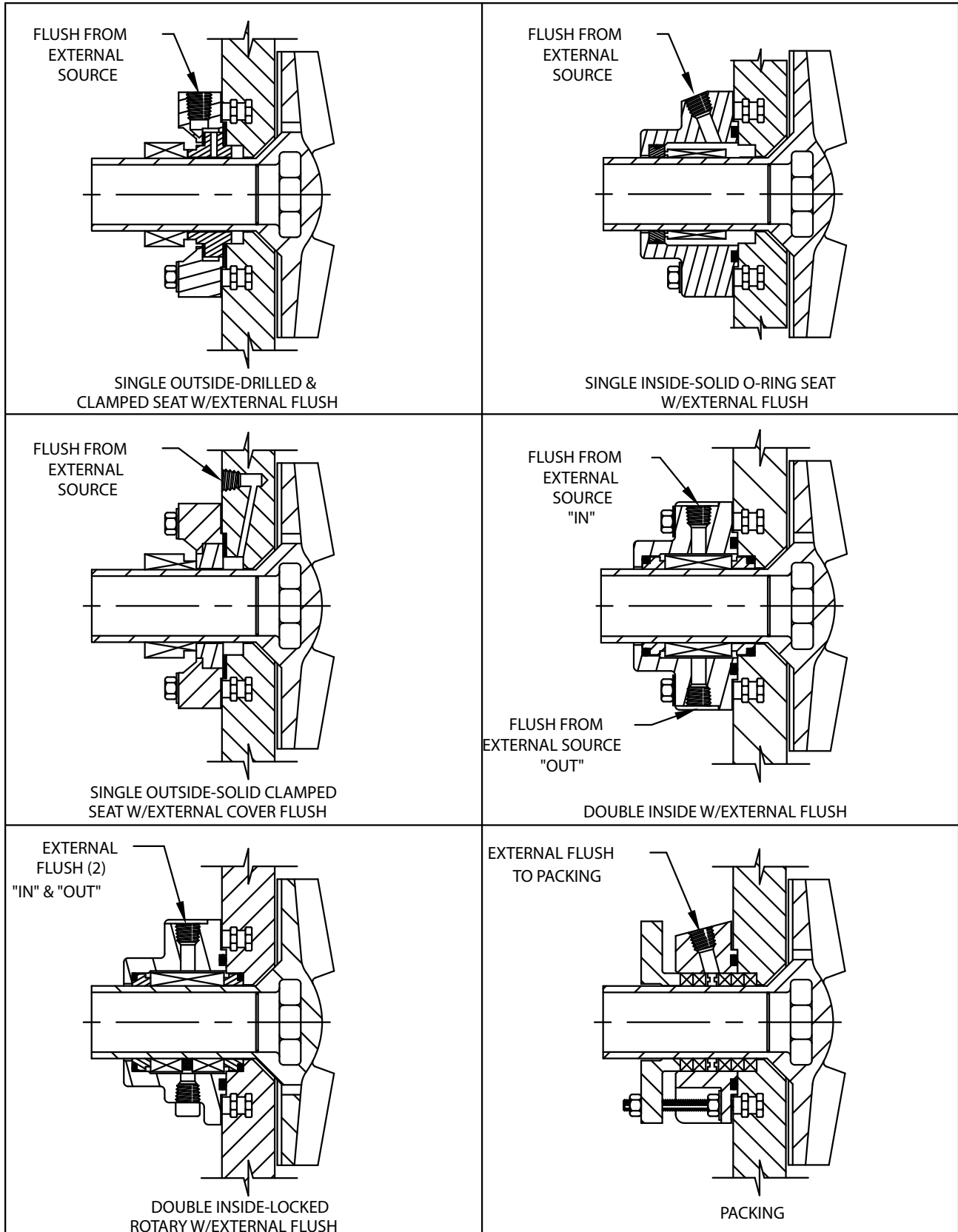

FLUSH PIPING FOR SINGLE MECHANICAL SEAL

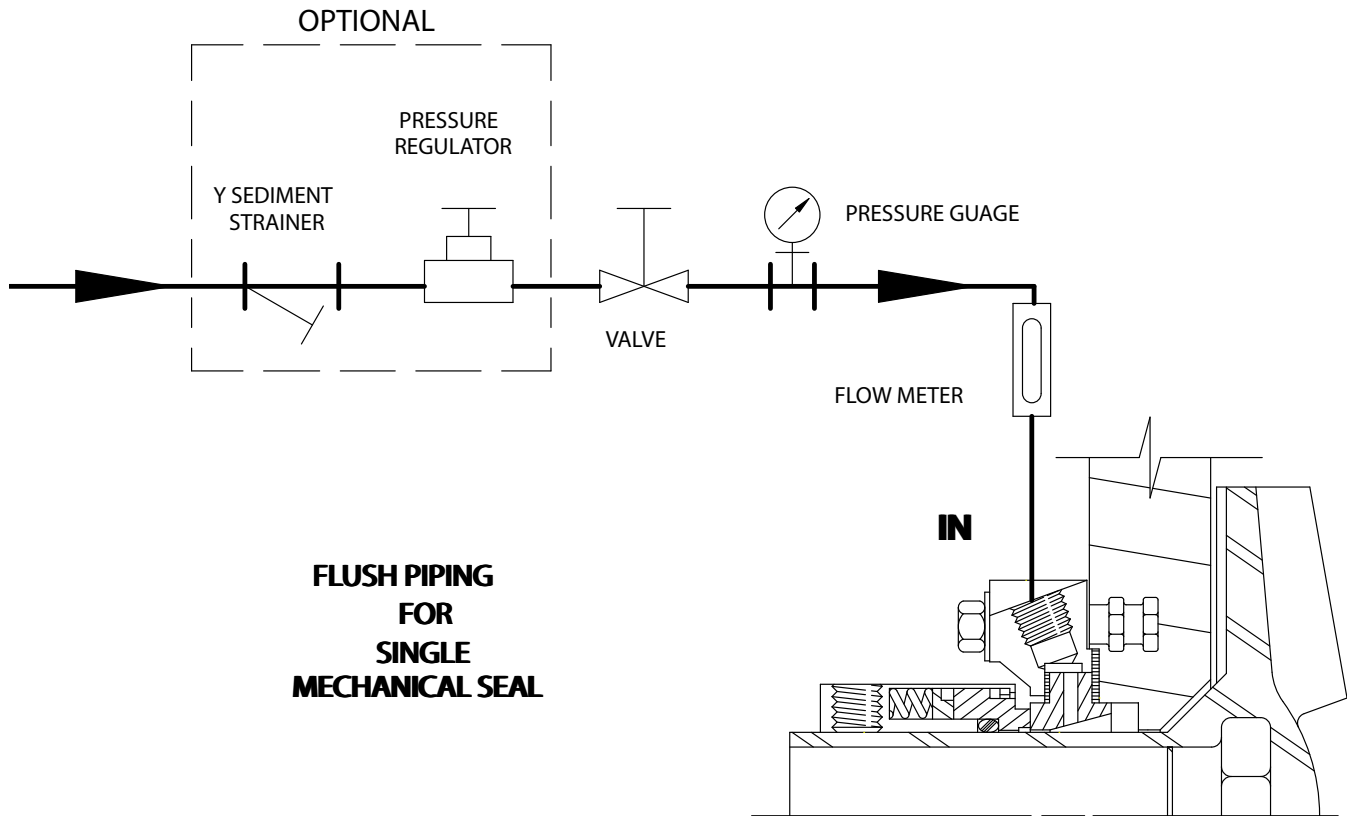

FLUSH FLOW RATE FOR SINGLE SEAL

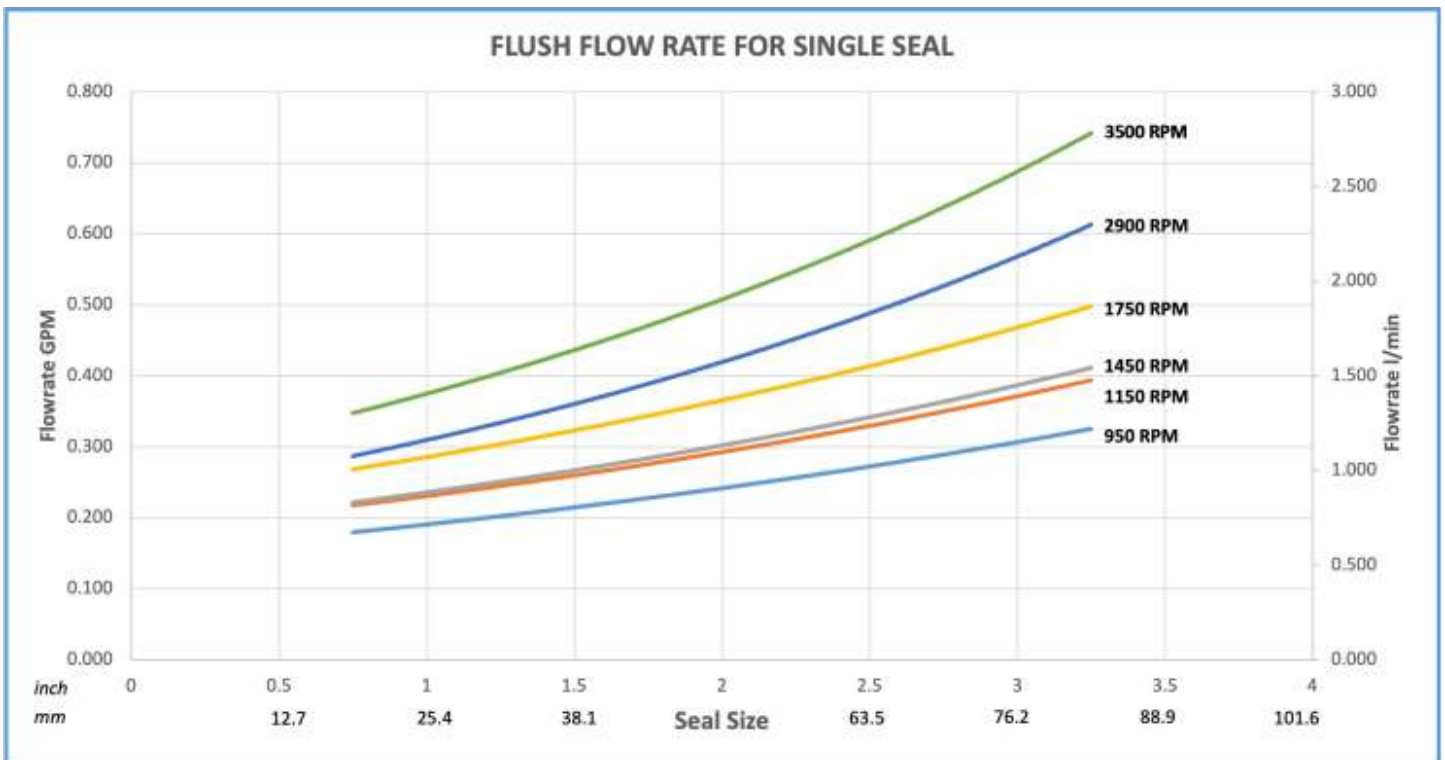

FLUSH PRESSURE = 15 TO 25 PSI ABOVE SEAL CHAMBER PRESSURE
 FLUSH LIQUID TEMPERATURE = 125oF (50oC) MAXIMUM

FLUSH PIPING FOR DOUBLE INSIDE MECHANICAL SEAL

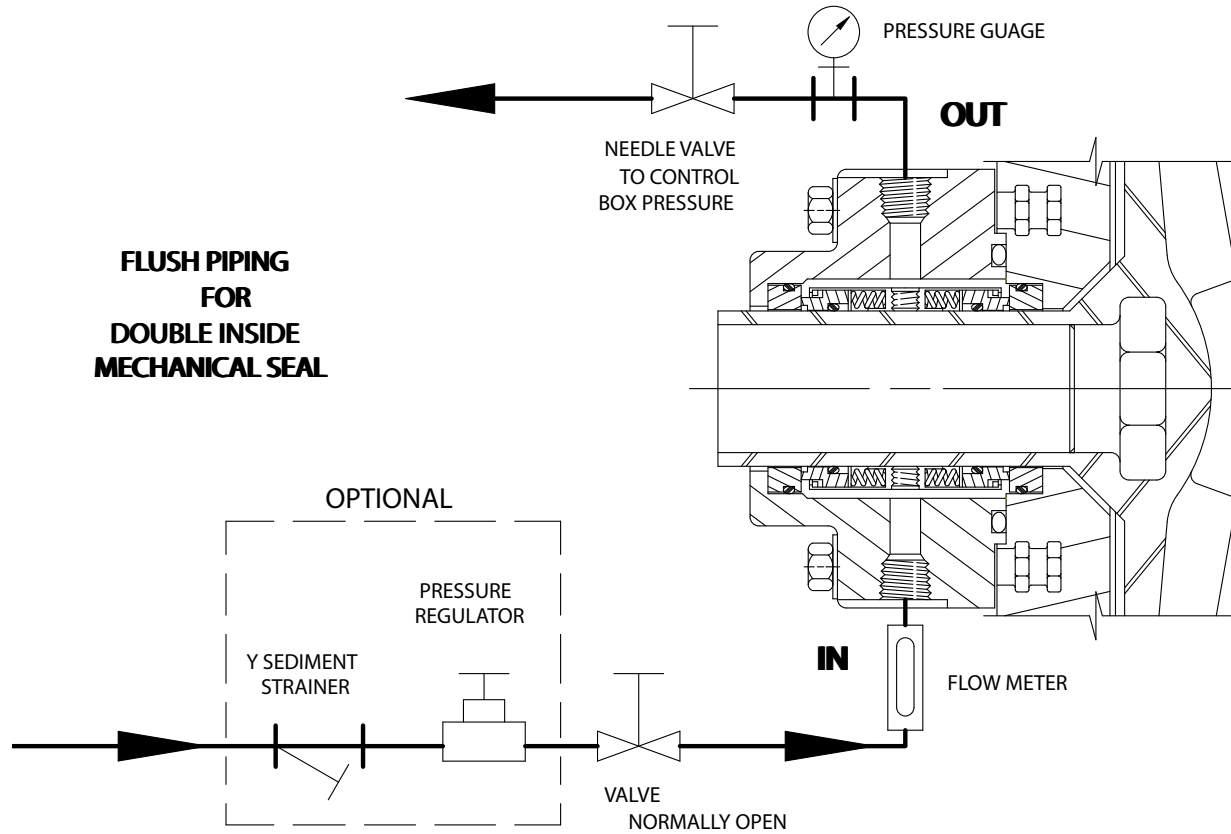

FLUSH FLOW RATE FOR DOUBLE SEAL

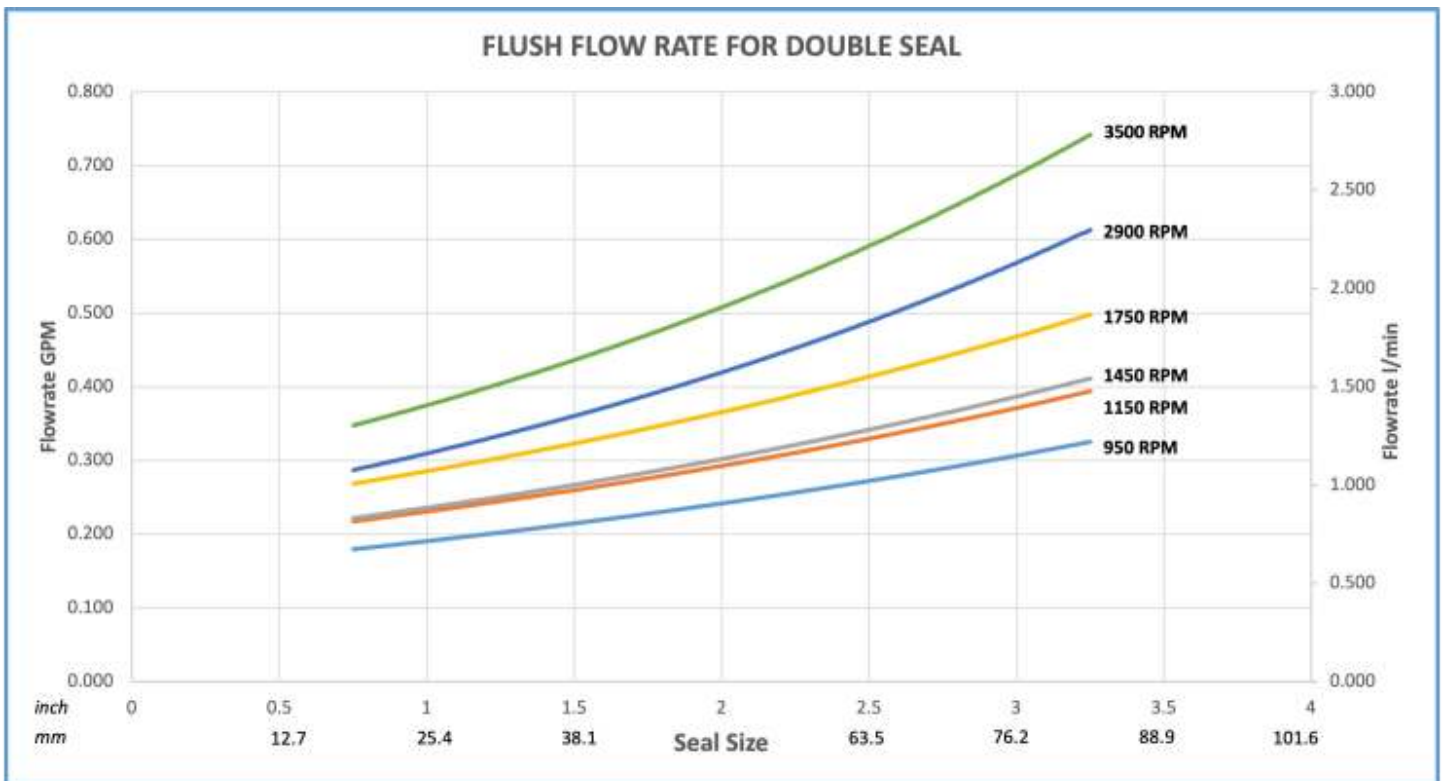

FLUSH PRESSURE = 15 TO 25 PSI ABOVE SEAL CHAMBER PRESSURE
 FLUSH LIQUID TEMPERATURE = 125oF (50oC) MAXIMUM

EU DECLARATION OF CONFORMITY



CECO Global Pump Solutions – CECO Fybroc Pump hereby declares that the following centrifugal pumps fully comply with the applicable health and safety requirements as specified by the EU directives listed.

The declaration is valid provided that the pumps have been fully assembled and no modifications have been made to these units.

TYPE OF DEVICES

Single Stage Centrifugal Pump and Motors

MODELS

R4144, R4146, R4174, R4176, R4184, R4186, R4244, R4246 RA2096, RA3146, RA3186, RWA2096, RWA4166, RWA4206

This document declares that the equipment provided complies with the essential requirements of the Machinery Directive 2006/42/EC.

THE FOLLOWING ARE THE EHSR REQUIREMENTS FULFILLED.

SPECIFIC STANDARDS APPLIED

1. EN ISO 12100: 2010 – Safety of Machinery – General Principles for

Design – Risk Assessment and Risk Reduction

2. EN 809: 1998+A1: 2009 – Pump and Pump Units for Liquids. Common Safety Requirements

Equipment and Protective Systems Intended For Use In Potentially Explosive Atmospheres (2014/24/EU)

APPLICABLE HARMONIZED STANDARDS EU Standard EN ISO 80079-36

EU Standard EN ISO 80079-37

All components of the completed machine must adhere to the requirements of the Machinery Directive and must be marked appropriately. Partly completed machinery(pump) outlined in this declaration must not be put into service until the final machinery into which it is to be incorporated has been declared in conformity with the provisions of this Directive

Upon justified request, CECO shall be obligated to provide the specific documents regarding the products listed above within an adequate period. The documents will be made available via email.

Signed for on behalf of CECO Environmental, Specialty Pumps

CECO Fybroc Pump

6040 Guion Road Indianapolis, IN, 46254 (317) 293-2930

Brian Schnelzer

Global Technology Growth Leader

Date

Person(s) Authorized to Compile technical File:

European Contact:

Fred Jan Weggen | Managing Director

Mefiag Filtration Group | a CECO Environmental Brand
Magnesiumweg 2 | 8445 PJ Heerenveen | The Netherlands
Phone: +31 513 630 230

United States Contact:

Brian K. Schnelzer | Global Technology Growth Leader
CECO Fybroc Pump

6040 Guion Road

Indianapolis, IN 46254

(317) 293-2930

READ WARNINGS

HAZARDOUS SITUATIONS MAY OCCUR UNLESS THIS EQUIPMENT IS APPLIED, INSTALLED, OPERATED, AND MAINTAINED BY THOROUGHLY QUALIFIED PERSONNEL IN STRICT ACCORDANCE WITH THE INSTRUCTION MANUAL AND ALL APPLICABLE DRAWINGS AND CODES.

Read the instruction manual completely, before installing, filling, operating, or maintaining this equipment.

Obtain, read, and heed the MSDS (Material Safety Data Sheet) for the fluids being handled before attempting to fill, operate or maintain this equipment.

Obtain instructions from the Safety Engineer responsible for your facility before performing any work on the pumping equipment and systems.

APPLICATION AND REAPPLICATION - At the time of installation, the equipment received should have already been selected for the service required. You must read the paperwork for the installation and check serial number of the pump to assure that you are installing the correct pump into the service for which it was selected.

Many pumps look identical from the outside but can be made of different materials and/or be constructed differently inside. Personal injury, death, equipment damage, product (pumpage) damage, and/or product loss could occur if the incorrect pump is installed.

Do not transfer an existing pump to any other service conditions until you have thoroughly reviewed the pump construction, materials, sizing, sealing, pressure containing capability, head/capacity capability, and temperature capability with respect to the required service. Consult your CECO Fybroc PUMP sales engineer with all the service requirements and a full description of the existing pump (including the serial number), seal, and sub-systems so that we can assist you in a successful reapplication.

INSTALLATION - Always wear the appropriate protective apparel when working on or around the pumping equipment.

Safety glasses with side shields, heavy work gloves (use insulated work gloves when handling hot items), steel-toed shoes, hard hat, and any other protective gear as needed for protection. One example of other gear would be breathing apparatus when working near toxic materials.

Use lifting devices, manufactured expressly for the purpose of lifting, to move the pumping machinery. Do not attempt to lift the assembly or its components manually. Use only devices with lifting capabilities in excess of the weight of the unit being lifted. Inspect straps, chains, hooks, etc. for damage and lifting capability before use. Lift only at the center of gravity.

Personal injury, death, and/or equipment damage could occur if good lifting practices are not used. Install the equipment on a properly designed and built foundation.

Assure that the driver (motor, turbine, or engine) shaft is properly aligned to the pump shaft.

Connect the suction and discharge piping without forcing the piping into position. The pipe flanges must line up with the pump flanges "freely". Strain caused by "forcing" and/or misalignment may cause failure of the pumping unit, flanges, and/or the piping resulting in fluid (pumpage) release. This could cause personal injury, death and/or damage to this and/or other equipment.

Install a "new" bolt, of the correct size per ASME/ANSI B16.5 and the correct material per ASME/ANSI B16.5, in every bolt hole. Tighten all bolts evenly. Use only new uncorroded fasteners.

Improper flange bolting may cause failure of the pumping unit, flanges, piping, and/or fluid (pumpage) release which could cause personal injury, death, and/or damage to this and/or other equipment.

Connect all other (auxiliary) piping necessary for safe and successful operation of the equipment in the specific service conditions of the application. Make sure that all piping is installed into its correct connection. Installation of a pipe into an incorrect location could result in an explosion and personal injury or death as well as damage to this and/or other equipment.

Install pressure relief valves in any cavities that could be subjected to pressures in excess of the allowable working pressure of that cavity. Explosion, personal injury, death, and/or damage to this and/or other equipment may occur if pressure exceeds allowable.

Recheck the alignment between the driver (motor, turbine, or engine) and pump shafts. Installation of piping may have forced the pump out of alignment. If so, correct the piping to remove the distorting load.

Check to be certain that the shaft coupling spacer is not installed, and then gently bump the motor starter to check the rotational direction of the motor. If this is not in the direction of rotation required for the pump, make the necessary corrections.

Lock-out the power to the driver (motor, turbine, engine, etc.)

Install the shaft coupling spacer. Be sure that you install all the retaining devices and bolts and that they are tight.

Read and comply with the coupling manufacturer's instructions. Personal injury, death, and/or equipment damage could occur if the coupling spacer is not properly installed. Remove all debris and tools from the area near the shafts and the shaft coupling. Do this to assure that nothing is caught and thrown by the rotating parts when the pump is started. Bolt the coupling guard securely to the baseplate, checking to assure that it is not contacting any parts that will rotate when the pump is started.

FILLING - Before filling the pump with liquid, check to see that all possible leak locations are sealed. See that all of the connections into the pressure containing cavity are sealed or connected to a related piping system that also has all possible leak paths sealed. Do not plug unused jacket cavities, as this could develop dangerous pressure buildup.

Use a wrench on all bolted joints to apply torque to assure that all gaskets are sealed in a tight joint. Check to see that all threaded pipe connections are also tight enough to seal the liquid pressure that will be applied when the system is started.

OPERATING - Before starting the unit, see that all personnel are a safe distance away from all possible hazards, that all sub-systems are connected and operating, that all debris has been removed, that the shaft coupling guard is securely in place, and that the pump is full of liquid.

Do not operate this pump at shut-off (no flow) as an explosion may result. This can occur with any liquid, even "cold water". Personal injury, death, equipment damage, and/or loss of product (pumpage) is likely to occur. If your system is operated where it is possible for all outlets for the discharge from the pump to be closed while the pump is still operating, a modification of the system needs to be made to assure a continual flow of pumpage through the pump. Note that some people have a belief that a bypass line from the discharge side of the pump to the suction side of the pump will relieve this problem, this is "NOT TRUE", DO NOT ATTEMPT THIS.

MAINTENANCE, DISASSEMBLY AND REPAIR - Work must be performed only by thoroughly trained and qualified personnel to assure quality repair and to reduce the possibilities of injury to personnel and/or damage to equipment. If you do not have personnel who are capable of safe quality repair of this equipment, we advise you to return the equipment to CECO Fybroc PUMP to be repaired.

When it is necessary to open the pump and/or the pumping system, the fluid will be exposed to the atmosphere and personnel in the area. For the safety of all involved, the risk of exposure of personnel to the hazards of the pumpage can be reduced by flushing the entire system with a compatible non-toxic, non-hazardous, stable liquid before opening the pump or the system. In all cases, where the system is flushed or not, use the utmost care around the pumpage and the pumping system.

Always wear the appropriate protective apparel when working on or around the pumping equipment. Safety glasses with side shields, heavy work gloves (use insulated work gloves when handling hot items), steel-toed shoes, hard hat, and any other protective gear as needed for protection. One example of other gear would be breathing apparatus when working near toxic materials.

Use only top quality tools.

Stop the pump. Turn off the power supply (electricity, steam, etc.) to the pump driver (motor, turbine, engine, etc.) and lock the switching device so that it cannot be restarted. Tag the switching device so that no one will attempt to restart the unit.

Close the suction and discharge valves completely to isolate the pump from the system. Lock the valves in the closed position and tag them so that no one will attempt to open them.

Turn off, lock out, and tag all sub-systems and auxiliary equipment and auxiliary supply lines to isolate the pumping unit from any and all power, energy, and/or fluids.

Do not attempt to perform any work on the unit until you are confident that the pump and its contents have been stabilized at ambient temperature, and atmospheric pressure.

Put on protective wear to protect human tissue from attack by the fluids contained in the pump and any sub-systems, and from any vapors or fumes that could possibly be released from these fluids. This could mean breathing apparatus, face shields, heavy long sleeve rubber gloves, rubber apron, hood, and possibly more, dependent of course on the properties of the fluids involved and the installed drain and vent piping arrangement. Personal injury and/or death can occur if adequate precautions are not taken with regard to the fluid, the installation, and the possibilities of the release of fluid, vapors, and/or fumes.

Remove the coupling guard. Remove the coupling spacer.

Drain all the fluids from the auxiliary sub-systems (lubrication, cooling, heating, seal barrier, etc.) that are connected to the pump. Drain each fluid into a separate container. Use caution required for each fluid after reading the MSDS (Material Safety Data Sheet) for each.

Flush each sub-system with a compatible, non-toxic, non-hazardous, stable liquid. Drain into individual containers for each fluid. Disconnect and remove all auxiliary piping.

Carefully bleed off any pressure remaining in the pump. Pressure remaining in the pump will be dependent upon the pressure in the system when the pump was stopped; the quality, type, and condition of the isolation valves; the thermal expansion valves of the fluid and the pump material; and the change in the vapor pressure of the fluid between the temperature at the time the isolation valves were closed and the ambient temperature. Bleeding must be through a valved drain line piped to a closed container mounted lower than the pump. The container must be arranged with a relief passage to some point where pressure and fumes will not be harmful to personnel. The container must also have a level device so that determination can be made that sufficient fluid has been drained to empty the pump cavity and the volume of fluid that was contained in the run of suction and discharge pipe between the isolation valves and the pump. After the initial rush of fluid from the pump relieves the pressure, the drain valve can be opened further to speed the draining operation. When fluid quits running into the drain tank, gauge the volume to see if it is sufficient to have fully drained the contents of the pump and the suction and discharge pipes between the isolation valves.

If the system was constructed without any drain connections, it will be necessary to consult the designers of the system for safe draining procedures.

Now drain any small piping, that contains the fluid pumped, from all low points, into the same container used to drain the pump. Do not drain any other fluids (different than the pumpage) into this container as they may not be compatible. Personal injury, death, and/or equipment damage could occur.

Even though it might appear that, the cavity being drained has completely drained, be extremely careful about opening the system and/or opening the pump. If something solid in the pumpage moves to the vicinity of the drain connection, it could seal-off the drain and maintain pressure in the cavity thought to have been drained. It is also possible that the isolation valves are not sealing and therefore allowing liquid to flow from the system into the pump.

Personal injury, death, and/or equipment damage may occur if intense caution is not exercised.

Because of the above possibility, when you loosen the gasketed joint at the back of the casing (5), loosen the bolts or nuts only one full turn, and then use jack screws to break the gasket seal. If fluid and/or pressure remains in the pump, it will spray out now. Use extreme caution, wearing protective gear, to avoid injury. Do not proceed with disassembly until leakage ceases completely. If leakage does not cease, the isolation valves may not be sealing. Note that if the pump was purchased with out a drain, the pump will contain fluid which will flow out at the time the bolts are loosened and the gasket seal is broken.

When you open the pump, the fluid will be exposed to the atmosphere and personnel in the area. For the safety of all involved, the risk of exposure can be reduced by flushing the cavity that was just drained, with a compatible non-toxic, non-hazardous, stable liquid, before disassembling the pump.

Remove the casing bolts or nuts and using mechanical lifting apparatus to support the weight, pull the rotating unit from the casing.

Flush the wetted parts now exposed with compatible, non-toxic, non-hazardous, stable liquid.

Remove the gasket from the face of the casing (5) or the bearing housing (26) dependent on which one the gasket may have adhered to. The type of gasket and material of construction will vary with service requirements. Attack by prying and then, if necessary, layering off the old gasket with a sharp scraper, attempting to remove it in the largest possible pieces. Wear heavy leather, long sleeve work gloves when using the scraper. Wet the gasket before and during the scraping operation to reduce the possibility of fibers becoming airborne. Wear a respirator during this operation and until all debris has been disposed of in a plastic bag. Remove all of the gasket material down to clean metal surfaces on both parts that contacted the gasket. Place all of the gasket residue in a plastic bag, seal the bag and dispose of it in compliance with all government requirements.

The rotating assembly of the pump can now be moved to a more convenient location for further disassembly. Use only high quality tools. Flush parts as disassembled to removed hazardous residue from the pumpage and/or sub-system fluids.

Wear protective equipment as advised at the beginning of these warnings. Use mechanical lifting equipment to lift assemblies and components.

Do not apply heat to parts to assist in disassembly. Explosion could occur causing personal injury, death, and/or damage to equipment.

Do not attempt to drill, saw, or otherwise cut parts to remove them. Explosion and/or fuming could occur causing personal injury, death, and/or equipment damage.

Do not hammer on any parts. Personal injury and/or damage to equipment may occur.

Do not attempt to manufacture parts or modify CECO Fybroc Pump parts in any manner. Death, personal injury, and/or damage to equipment may occur.

One example of the above would be overboring the seal chamber, which removes metal that is required to contain fluids. Removal of this metal reduces the pressure containing capability of the part, and may create a leak path through the part.

Replace all gaskets, seals, bearings, and lubricants. Replace all parts that have worn, corroded, eroded, or otherwise deteriorated.



Use only CECO Fybroc Pump Division of CECO Environmental Corporation parts.

CECO Fybroc



Illinois Location:
(847) 841-7867
860 Church Rd
Elgin, IL 60123

Minnesota Location:
(651) 758-7867
330 Mill Bay South Suite 1511
Afton, MN 55001
PumpSupplyInc.com



CECO Fybroc Pump

700 Emlen Way • Telford, PA 18969

P: (215) 723-8155 • **TOLL-FREE:** (800) FYBROC-1 • **F:** (215) 723-2197

infoFHS@onececo.com • <https://www.cecoenviro.com/fybroc>

