



mROY® metering pumps

Delivering Unrivaled Accuracy and Reliability with the
Worldwide Industry Standard for Critical Process Control



The Force in Pump Technology

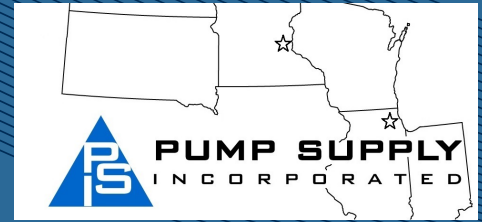

mROY[®] metering pump

Introducing the redesigned mROY metering pump with enhanced features that sets the new standard in reliability and performance.

Milton Roy's dedication to continuous improvement means the world's most preferred metering pump has now stretched its lead even more. The redesigned mROY maximum uptime metering pumps bring an even higher level of performance, accuracy, and reliability to the legendary standard for metering pumps.

mROY[®] metering pump technology leads in meeting the demands of critical applications wherever chemical injection or dosing is required. This enhanced metering

pump features improved component durability, it is easier to prime, it performs more efficiently, and it is safer and simpler to maintain.

And, these mROY pumps earn the name by meeting all applicable regulations anywhere in the world where they operate.

It's not unusual to find mRoy pumps still operating at design performance after 20 or more years in service.

Performance chart

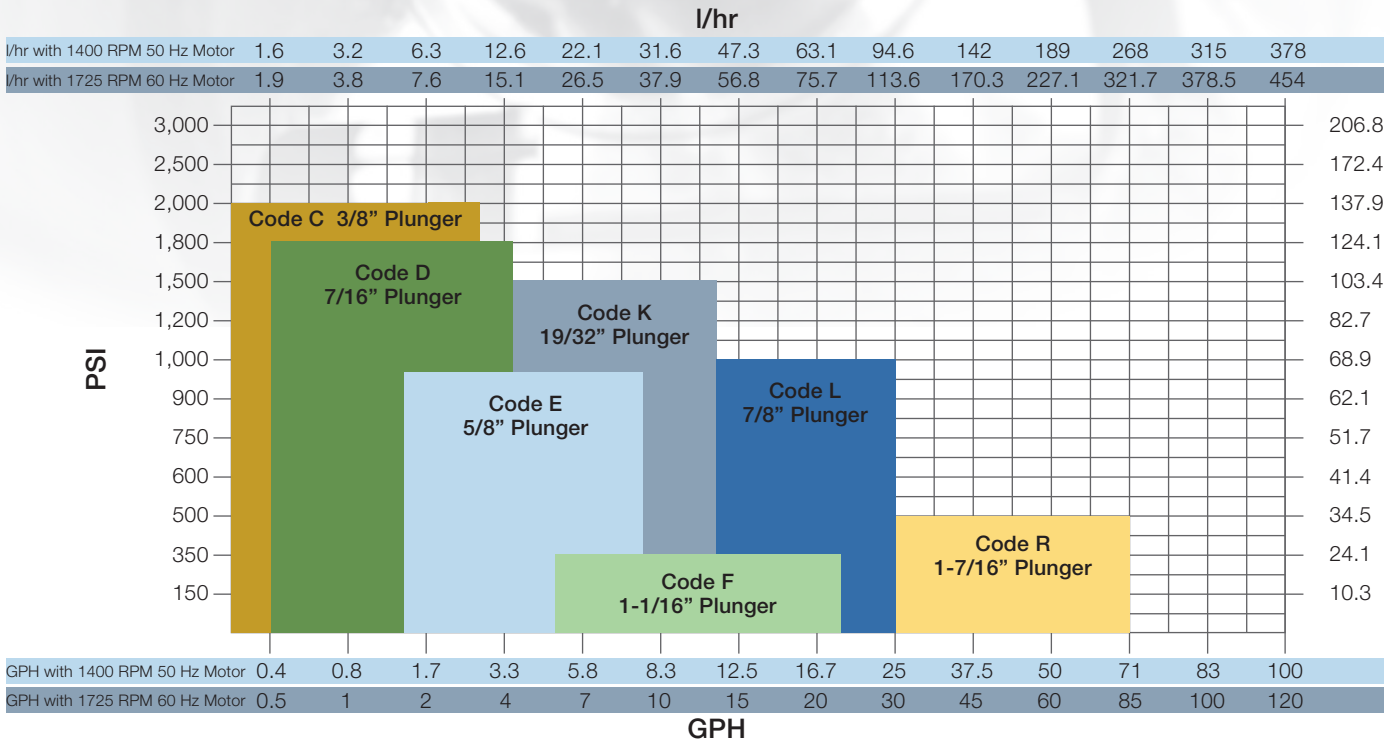

*Values are for simplex pumps only. For duplex configurations, the pressure will not change, but the capacity values will double.



A foundation of advanced, field-proven technology

It's simple: Don't rest on success. Pay attention to every detail. This philosophy has given mROY pumps high-value improvements while building upon our proven performance that makes Milton Roy a leader in controlled-volume metering pump technology.

Our innovations

Milton Roy continues to be the leading source of the most important advancements in metering pump technology. Significant innovations such as the high performance diaphragm, hydraulic bypass metering pump drive, and diaphragm rupture detection system can be found throughout the Milton Roy product line.

Our expertise

With over 75 years of experience, Milton Roy combines vast industry experience, a proven track record, and a culture of continuous technological improvement to provide customized solutions for all metering pump applications. Milton Roy delivers the most reliable, comprehensive range of metering pumps on the market today.

Our global network

With manufacturing, sales and service locations strategically located throughout the world, along with a channel partner network in almost every country worldwide, we can effectively serve you no matter where you are.



Features and Benefits

How Milton Roy improved the standard



mROY maximum uptime metering pumps are a product of industry leadership. They comprise a unique set of technical and performance advantages that deliver the extreme accuracy and high reliability you need for critical process control.

Dust-tight, cast-iron drive housing

provides a rugged enclosure for operation in any plant and field environment

Internal hydraulic pressure relief valve

automatically protects the hydraulic system from overpressure conditions

Micrometer capacity adjustment

for accurate output flow control

Metallic and non-metallic liquid end

materials, for corrosion resistance in any chemical application

Solid PTFE diaphragm

does not use seals and eliminates plunger packing maintenance

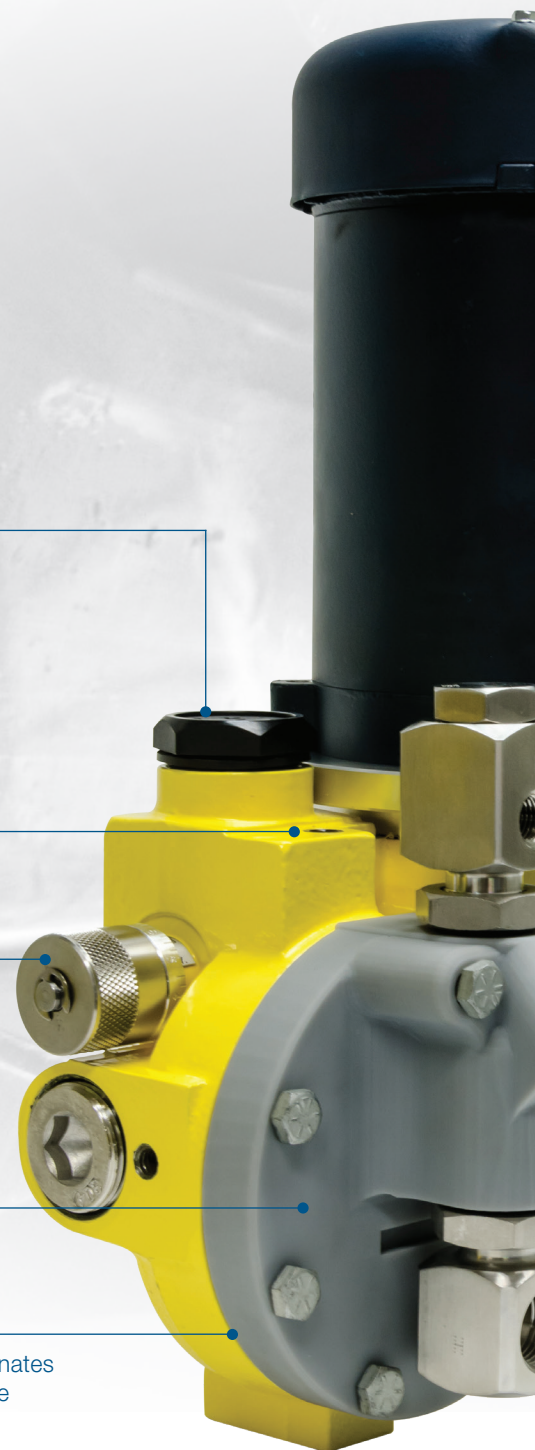



Performance by the numbers:

- Flow rate from 0.20 gph (0.8 l/hr) up to 79 gph (299 l/hr)
- Hydraulically balanced diaphragm, with 96,000-hour design life
- Turndown ratios up to 10:1 for a full range of adjustments based on plant treatment requirements
- Accuracy $\pm 1.0\%$ over a 10:1 turndown ratio
- Three-year warranty

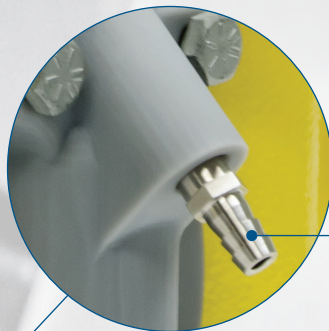

Liquid end bleed system
makes it easier to commission a new or a newly maintained pump

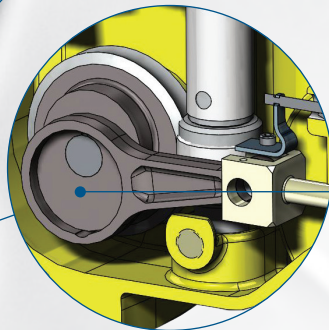

Worm-and-pinion drive
produces a smooth, continuous mechanical motion that eliminates wear and tear of mechanical, lost-motion designs



Precision suction and discharge check valve
assures accuracy and repeatability of every mRoy pump



Features and Benefits

Options and accessories for specific applications

A wide range of options and accessories are available to customize mROY metering pumps for your most complex process needs.

Unique, redundant diaphragm protects against process disruption. mROY maximum uptime metering pumps include redundant diaphragm technology, with an integral diaphragm rupture detection system. These two proprietary Milton Roy innovations provide highly effective protection for pump internals against extremely hostile chemicals, or potential process contamination by hydraulic fluids.

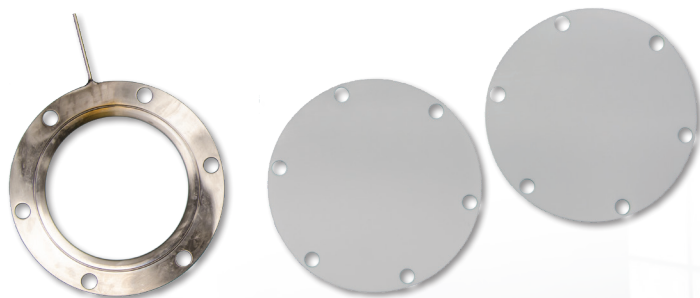

Essentially, the system consists of two diaphragms separated by a hollow intermediate ring or a series of special shims. The two diaphragms are pushed tightly together and are separated only on their outer edge. Because there is no fluid and very little air between the two diaphragms, the area between the two diaphragms does not experience pressure from the process unless one of the diaphragms fails. Should a diaphragm fail, a pressure gauge provides visual indication. An optional pressure switch provides a contact closure for alarm and/or system shutdown.



Electronic Capacity Control is one of the most popular of these options for the mRoy series. The electronic capacity control enables the pump to accept capacity change commands from a remote location, or automatically by process signal.

Other mROY options include:

- Integral duplex
- Double diaphragm
- High or low operating condition options
- Remote liquid ends
- Liquid-end venting (outgassing liquids)
- Heating/cooling liquid-end jackets
- Slurry or viscous fluid options
- Motor choices
- Pipe connections

We can also perform custom modifications for your specific requirements. Contact your Milton Roy representative for more information.

mROY accessories include:

- Backpressure valves
- Safety valves
- Pulsation dampeners
- Calibration columns
- Degassing valves and systems



Making mROY pumps work for you

For integrators

Specifying mROY metering pumps for critical systems gives process systems integrators the best guarantee of reliability, accuracy, and performance in challenging environments. When doing cost/benefit calculations, there are many great reasons why mROY metering pumps is the answer that comes up more often than any other.



For operators

When you need to replace a metering pump, replacing it with the same pump may be the simplest answer, from an installation point of view. But it's not necessarily the best solution. Gaining the benefits of mROY pump technology can be worth far more in the long run than the short-term cost of installation modifications. Ask your Milton Roy representative to calculate the benefit you stand to gain from the most important system upgrade you can make.

Ingersoll Rand (NYSE:IR) advances the quality of life by creating comfortable, sustainable and efficient environments. Our people and our family of brands—including Club Car®, Ingersoll Rand®, Thermo King® and Trane®—work together to enhance the quality and comfort of air in homes and buildings; transport and protect food and perishables; and increase industrial productivity and efficiency. We are committed to a world of sustainable progress and enduring results.

info@miltonroy.com
www.miltonroy.com



<p><u>Illinois Location:</u> (847) 841-7867 860 Church Rd Elgin, IL 60120</p> <p><u>Minnesota Location:</u> (651) 758-7867 330 Mill Bay South Suite Afton, MN 55001</p> <p>PumpSupplyInc.com</p>	 <p>PS PUMP SUPPLY INCORPORATED</p>
---	---



© 2015 Milton Roy, LLC. All Rights Reserved. 06/2023
 Literature #IR-59190.00