

OPERATOR'S MANUAL PX20X-XXX-XXX-BXXX

INCLUDING: OPERATION, INSTALLATION AND MAINTENANCE

RELEASED: 2-2-05
 REVISED: 3-8-24
 (REV: U)

2" DIAPHRAGM PUMP 1:1 RATIO (METALLIC)



**READ THIS MANUAL CAREFULLY BEFORE INSTALLING,
 OPERATING OR SERVICING THIS EQUIPMENT.**

It is the responsibility of the employer to place this information in the hands of the operator. Keep for future reference.

SERVICE KITS

Refer to Model Description Chart to match the pump material options.

637309-XXX for fluid section repair **with** seats (see page 5).

637309-XX for fluid section repair **without** seats (see page 5).

NOTE: This kit also contains several air motor seals which will need to be replaced.

637374-X major air valve assembly (see page 8).

637421 for air section repair (see page 7).

PUMP DATA

Models..... See Model Description Chart for "-XXX"

Pump Type..... Metallic Air Operated Double Diaphragm

Material..... see Model Description Chart

Weight

- PX20A-XAX-XXX-BXXX 91.4 lbs (41.5 kgs)
 - PX20A-XCX-XXX-BXXX 147.4 lbs (66.9 kgs)
 - PX20A-AHX-XXX-BXXX, -BHX... 155.0 lbs (70.3 kgs)
 - PX20A-ASX-XXX-BXXX, -BSX... 149.8 lbs (68.0 kgs)
 - PX20A-FHX-XXX-BXXX 169.4 lbs (76.8 kgs)
 - PX20A-FSX-XXX-BXXX 162.0 lbs (73.5 kgs)
- (add 28.9 lbs [13.1 kg] for stainless steel air motor section)

- Maximum Air Inlet Pressure** 120 psig (8.3 bar)
- Maximum Material Inlet Pressure** 10 psig (0.69 bar)
- Maximum Outlet Pressure** 120 psig (8.3 bar)
- Maximum Flow Rate** 172 gpm (651 lpm)
- Displacement / Cycle @ 100 psig.** 1.4 gal. (5.3 lit.)
- Maximum Particle Size** 1/4" dia. (6.4 mm)
- Maximum Temperature Limits (diaphragm / ball / seal material)**
- E.P.R. / EPDM -60° to 280° F (-51° to 138° C)
- Hytre[®] -20° to 180° F (-29° to 82° C)
- PVDF..... 10° to 200° F (-12° to 93° C)
- Nitrile 10° to 180° F (-12° to 82° C)
- Santoprene[®] -40° to 225° F (-40° to 107° C)
- PTFE 40° to 225° F (4° to 107° C)
- Viton[®]..... -40° to 350° F (-40° to 177° C)

Dimensional Data..... see page 9

Noise Level @ 70 psig, 60 cpm^① . 85.0 dB(A)^②

① Tested with 67263 muffler assembly installed.
 ② The pump sound pressure levels published here have been updated to an Equivalent Continuous Sound Level (L_{Aeq}) to meet the intent of ANSI S1.13-1971, CA-GI-PNEUROPS 55.1 using four microphone locations.

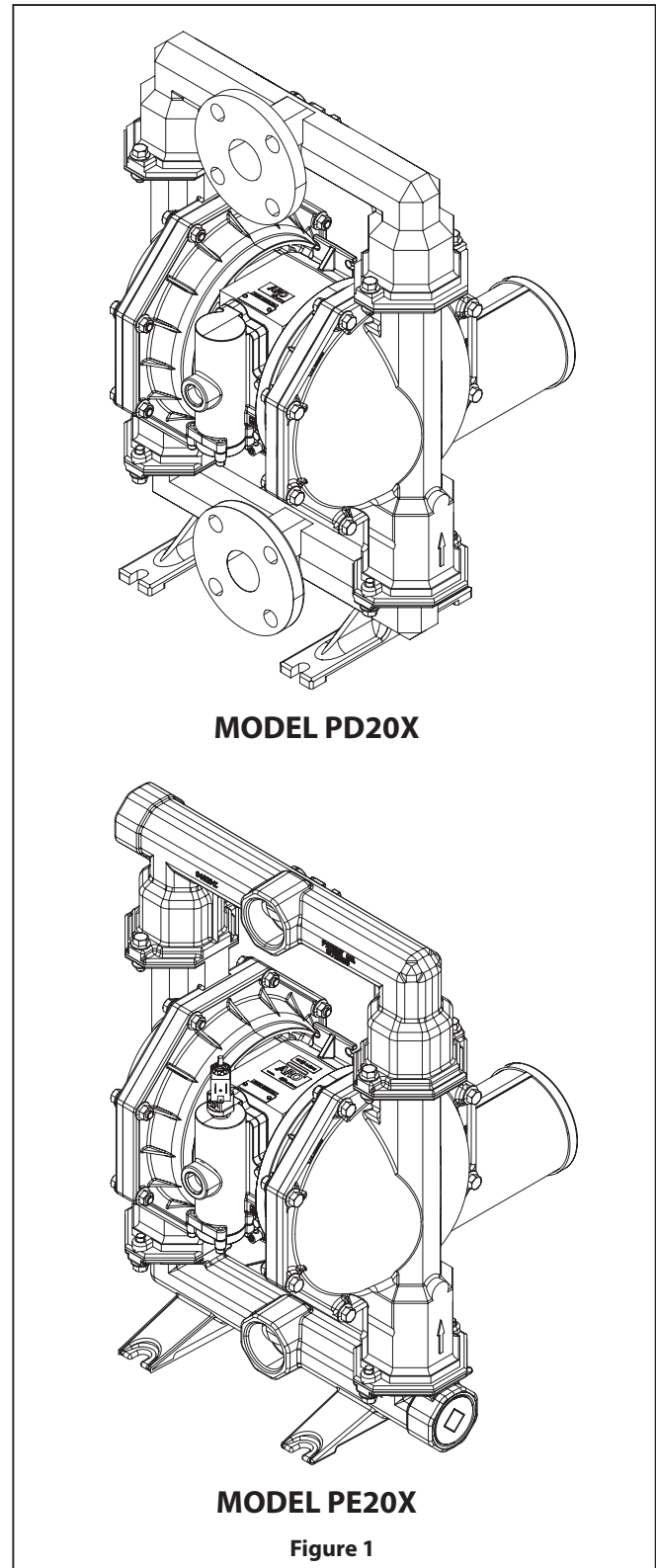

MODEL PD20X

MODEL PE20X

Figure 1



MODEL DESCRIPTION CHART

Model Code Explanation

Example:

PX20 X - X X X - X X X - B X X X

Model Series

PD20- Standard Pump

PE20- Electronic Interface

Air Motor / Air Cap Material

A - Aluminum

S - Stainless Steel

Fluid Connection

A - 2 - 11-1/2 NPT - 1

B - Rp 2 (2 - 11 BSP parallel)

F - 2" ANSI / DIN Flange

Fluid Caps & Manifold Material

A - Aluminum

C - Cast Iron

H - Hastelloy - C

S - Stainless Steel

Hardware Material

P - Carbon Steel

S - Stainless Steel

Seat Material

A - Santoprene

C - Hytrel

E - Carbon Steel

F - Aluminum

G - Nitrile

H - Hard 440 Stainless Steel

K - PVDF

L - Hastelloy - C

S - 316 Stainless Steel

Ball Material

A - Santoprene

C - Hytrel

G - Nitrile

S - Stainless Steel

T - PTFE

V - Viton

Diaphragm Material

A - Santoprene

C - Hytrel

G - Nitrile

L - Long Life PTFE

M - Medical Grade Santoprene

T - PTFE / Santoprene

V - Viton

Revision

B - Revision

Specialty Code 1 (Blank if no Speciality Code)

A - Solenoid 120 VAC, 110 VAC AND 60 VDC

B - Solenoid 12 VDC, 24 VAC AND 22 VAC

C - Solenoid 240 VAC, 220 VAC AND 120 VDC

D - Solenoid 24 VDC, 48 VAC AND 44 VAC

E - Solenoid 12 VDC NEC / CEC

F - Solenoid 24 VDC NEC / CEC

G - Solenoid 12 VDC ATEX / IECEX

H - Solenoid 24 VDC ATEX / IECEX

J - Solenoid 120 VAC NEC / CEC

K - Solenoid 220 VAC ATEX / IECEX

N - Solenoid with no Coil

P - Ported Motor (No Major Valve)

0 - Standard Valve Block (No Solenoid)

S - Cycle Sensing on Major Valve

Specialty Code 2 (Blank if no Speciality Code)

E - End of Stroke feedback + Leak Detection

F - End of Stroke feedback

G - End of Stroke ATEX / IECEX / NEC / CEC

H - End of Stroke + Leak Detection ATEX / IECEX / NEC / CEC

L - Leak Detection

M - Leak Detection ATEX / IECEX / NEC / CEC

R - End of Stroke NEC

T - End of Stroke NEC / Leak Detection NEC

U - Leak Detection ATEX / IECEX / CCC

0 - No Option

Special Testing

For Special Testing options, please contact your nearest **Ingersoll Rand** Customer Service Representative or Distributor.

NOTICE: All possible options are shown in the chart, however, certain combinations may not be recommended.

PX20X-XXX-XXX-BXXX (en)

OPERATING AND SAFETY PRECAUTIONS

READ, UNDERSTAND AND FOLLOW THIS INFORMATION TO AVOID INJURY AND PROPERTY DAMAGE.



⚠️ WARNING EXCESSIVE AIR PRESSURE. Can cause personal injury, pump damage or property damage.

- Do not exceed the maximum inlet air pressure as stated on the pump model plate.
- Be sure material hoses and other components are able to withstand fluid pressures developed by this pump. Check all hoses for damage or wear. Be certain dispensing device is clean and in proper working condition.

⚠️ WARNING STATIC SPARK. Can cause explosion resulting in severe injury or death. Ground pump and pumping system.

- Use the pump grounding screw terminal provided. Use ARO® part no. 66885-1 ground kit or connect a suitable ground wire (12 ga. min.) to a good earth ground source.
- Secure pump, connections and all contact points to avoid vibration and generation of contact or static spark.
- Consult local building codes and electrical codes for specific grounding requirements.
- After grounding, periodically verify continuity of electrical path to ground. Test with an ohmmeter from each component (e.g., hoses, pump, clamps, container, spray gun, etc.) to ground to insure continuity. Ohmmeter should show 0.1 ohms or less.
- Submerge the outlet hose end, dispensing valve or device in the material being dispensed if possible. (Avoid free streaming of material being dispensed.)
- Use hoses incorporating a static wire.
- Use proper ventilation.
- Keep inflammables away from heat, open flames and sparks.
- Keep containers closed when not in use.

⚠️ WARNING Pump exhaust may contain contaminants. Can cause severe injury. Pipe exhaust away from work area and personnel.

- In the event of a diaphragm rupture, material can be forced out of the air exhaust muffler.
- Pipe the exhaust to a safe remote location when pumping hazardous or inflammable materials.
- Use a grounded 1" minimum ID hose between the pump and the muffler.

⚠️ WARNING HAZARDOUS PRESSURE. Can result in serious injury or property damage. Do not service or clean pump, hoses or dispensing valve while the system is pressurized.

- Disconnect air supply line and relieve pressure from the system by opening dispensing valve or device and / or carefully and slowly loosening and removing outlet hose or piping from pump.

⚠️ WARNING HAZARDOUS MATERIALS. Can cause serious injury or property damage. Do not attempt to return a pump to the factory or service center that contains hazardous material. Safe handling practices must comply with local and national laws and safety code requirements.

- Obtain Material Safety Data Sheets on all materials from the supplier for proper handling instructions.

⚠️ WARNING EXPLOSION HAZARD. Models containing aluminum parts cannot be used with 1,1,1-trichloroethane, methylene chloride or other halogenated hydrocarbon solvents which may react and explode.

- Check pump motor section, fluid caps, manifolds and all wetted parts to assure compatibility before using with solvents of this type.

⚠️ WARNING MISAPPLICATION HAZARD. Do not use models containing aluminum wetted parts with food products for human consumption. Plated parts can contain trace amounts of lead.

⚠️ CAUTION Verify the chemical compatibility of the pump wetted parts and the substance being pumped, flushed or recirculated. Chemical compatibility may change with temperature and concentration of the chemical(s) within the substances being pumped, flushed or circulated. For specific fluid compatibility, consult the chemical manufacturer.

⚠️ CAUTION Maximum temperatures are based on mechanical stress only. Certain chemicals will significantly reduce maximum safe operating temperature. Consult the chemical manufacturer for chemical compatibility and temperature limits. Refer to PUMP DATA on page 1 of this manual.

⚠️ CAUTION Be certain all operators of this equipment have been trained for safe working practices, understand it's limitations, and wear safety goggles / equipment when required.

⚠️ CAUTION Do not use the pump for the structural support of the piping system. Be certain the system components are properly supported to prevent stress on the pump parts.

- Suction and discharge connections should be flexible connections (such as hose), not rigid piped, and should be compatible with the substance being pumped.

⚠️ CAUTION Prevent unnecessary damage to the pump. Do not allow pump to operate when out of material for long periods of time.

- Disconnect air line from pump when system sits idle for long periods of time.

⚠️ CAUTION Use only genuine ARO replacement parts to assure compatible pressure rating and longest service life.

NOTICE Replacement warning labels are available upon request: "Static Spark & Diaphragm Rupture" pn \ 94080.

| | |
|-------------------|---|
| ⚠️ WARNING | = Hazards or unsafe practices which could result in severe personal injury, death or substantial property damage. |
| ⚠️ CAUTION | = Hazards or unsafe practices which could result in minor personal injury, product or property damage. |
| NOTICE | = Important installation, operation or maintenance information. |

GENERAL DESCRIPTION

The ARO diaphragm pump offers high volume delivery even at low air pressure and a broad range of material compatibility options are available. Refer to the model and option chart. ARO pumps feature stall resistant design, modular air motor / fluid sections.

Air operated double diaphragm pumps utilize a pressure differential in the air chambers to alternately create suction and a positive fluid pressure in the fluid chambers, valve checks insure a positive flow of fluid.

Pump cycling will begin as air pressure is applied and will continue to pump and keep up with the demand. It will build and maintain line pressure and will stop cycling once maximum line pressure is reached (dispensing device closed) and will resume pumping as needed.

AIR AND LUBE REQUIREMENTS

⚠️ WARNING EXCESSIVE AIR PRESSURE. Can cause pump damage, personal injury or property damage.

- A filter capable of filtering out particles larger than 50 microns should be used on the air supply. There is no lubrication required other than the "O" ring lubricant which is applied during assembly or repair.
- If lubricated air is present, make sure that it is compatible with the "O" rings and seals in the air motor section of the pump.

OPERATING INSTRUCTIONS

- Always flush the pump with a solvent compatible with the material being pumped if the material being pumped is subject to "setting up" when not in use for a period of time.
- Disconnect the air supply from the pump if it is to be inactive for a few hours.
- The outlet material volume is governed not only by the air supply, but also by the material supply available at the inlet. The material supply tubing should not be too small or restrictive. Be sure not to use hose which might collapse.
- When the diaphragm pump is used in a forced-feed (flooded inlet) situation, it is recommended that a "check valve" be installed at the air inlet.
- Secure the diaphragm pump legs to a suitable surface to insure against damage by vibration.

PARTS AND SERVICE KITS

Refer to the part views and descriptions as provided on pages 5 through 8 for parts identification and service kit information.

- Certain ARO "Smart Parts" are indicated which should be available for fast repair and reduction of down time.
- Service kits are divided to service two separate diaphragm pump functions: 1. AIR SECTION, 2. FLUID SECTION. The Fluid Section is divided further to match typical part Material Options.

MAINTENANCE

- Provide a clean work surface to protect sensitive internal moving parts from contamination from dirt and foreign matter during service disassembly and reassembly.
- Keep good records of service activity and include the pump in preventive maintenance program.
- Before disassembling, empty captured material in the outlet manifold by turning the pump upside down to drain material from the pump.

FLUID SECTION DISASSEMBLY

1. Remove (61) outlet manifold and (60) inlet manifold.
2. Remove (22) balls, (19) "O" rings (if applicable) and (21) seats.
3. Remove (15) fluid caps.

NOTE: Only PTFE diaphragm models use a primary diaphragm (7) and a backup diaphragm (8). Refer to the auxiliary view in the Fluid Section illustration.

4. Remove the (6) diaphragm washer, (7) or 7 / 8 diaphragms and (5) backup washer.

NOTE: Do not scratch or mar the surface of (1) diaphragm rod.

FLUID SECTION REASSEMBLY

- Reassemble in reverse order. Refer to the torque requirements on page 6.
- Clean and inspect all parts. Replace worn or damaged parts with new parts as required.
- Lubricate (1) diaphragm rod and (144) "U" cups with Lubriplate® FML-2 grease (94276 grease packet is included in service kit).
- For models with PTFE diaphragms: Item (8) Santoprene diaphragm is installed with the side marked "AIR SIDE" towards the pump center body. Install the (7) PTFE diaphragm with the side marked "FLUID SIDE" towards the (15) fluid cap.
- Re-check torque settings after the pump has been re-started and run a while.

Illinois Location:

(847) 841-7867
860 Church Rd Elgin, IL 60120

Minnesota Location:

(651) 758-7867
330 Mill Bay South Suite :
Afton, MN 55001

PumpSupplyInc.com



PUMP SUPPLY
INCORPORATED

PX20X-XXX-XXX-BXXX (en)

PARTS LIST / PX20X-XXX-XXX-BXXX FLUID SECTION

FLUID SECTION SERVICE KITS (637309 -XXX or 637309 -XX)

★ **For Fluid Kits With Seats:**

637309-XXX Fluid Section Service Kits include: Seats (see SEAT Option, refer to -XXX in chart below), Balls (see BALL Option, refer to -XXX in chart below), Diaphragms (see DIAPHRAGM Option, refer to -XXX in chart below), and items: 19, 70, 144 and 175 (listed below) plus 174 and 94276 Lubriplate FML-2 grease (page 7).

★ **For Fluid Kits Without Seats:**

637309-XX Fluid Section Service Kits include: Balls (see BALL Option, refer to -XX in chart below), Diaphragms (see DIAPHRAGM Option, refer to -XX in chart below), and items: 19, 70, 144 and 175 (listed below) plus 174 and 94276 Lubriplate FML-2 grease (page 7).

EXTERNAL HARDWARE OPTIONS PX20X-XXX-XXX-BXXX

| Item | Description (size) | Qty | PX20X-XXP | | PX20X-XXS | |
|------|--------------------------------|------|-----------|-----|-----------|------|
| | | | Part No. | Mtl | Part No. | Mtl |
| 26 | Screw (M10 x 1.5 - 6g x 34 mm) | (8) | 94409-1 | [C] | 94409-2 | [SS] |
| 27 | Bolt (M10 x 1.5 - 6g x 45 mm) | (16) | 94990-1 | [C] | 94990 | [SS] |
| 29 | Nut (M10 x 1.5 - 6h) | (16) | 94992-1 | [C] | 94992 | [SS] |

✓ Air Section Service Kit Parts, see pages 7 and 8.

COMMON PARTS

| Item | Description (size) | Qty | Part No. | Mtl |
|--------|-----------------------------------|-----|----------|------|
| 1 | Connecting Rod | (1) | 97386 | [C] |
| 43 | Ground Lug (see page 8) | (1) | 93004 | [Co] |
| ★✓ 70 | Gasket | (2) | 94100 | [B] |
| ★✓ 144 | "U" Cup (3/16" x 1-3/8" OD) | (2) | Y186-51 | [B] |
| ✓ 180 | Gasket (0.406" ID x 0.031" thick) | (4) | 94098 | [Co] |

SEAT OPTIONS PX20X-XXX-XXX-BXXX

| ★ "21" | | | | | | | |
|--------|---------|-----|------|------|---------|-----|-------|
| -XXX | Seat | Qty | Mtl | -XXX | Seat | Qty | [Mtl] |
| -AXX | 94328-A | (4) | [Sp] | -HXX | 94354 | (4) | [SH] |
| -CXX | 94328-C | (4) | [H] | KXX | 94477-K | (4) | [K] |
| -EXX | 95677 | (4) | [C] | -LXX | 95639 | (4) | [Ha] |
| -FXX | 95673 | (4) | [A] | -SXX | 94353 | (4) | [SS] |
| -GXX | 94328-G | (4) | [B] | | | | |

NOTE: Seat options -AXX, -CXX and -GXX do not require item 19 "O" ring.

BALL OPTIONS PX20X-XXX-XXX-BXXX

| ★ "22" (2-1/2" dia.) | | | | | | | |
|----------------------|---------|-----|------|------|---------|-----|------|
| -XXX | Ball | Qty | Mtl | -XXX | Ball | Qty | Mtl |
| -XAX | 93358-A | (4) | [Sp] | -XSX | 94805 | (4) | [SS] |
| -XCX | 93358-C | (4) | [H] | -XTX | 93358-4 | (4) | [T] |
| -XGX | 93358-2 | (4) | [B] | -VXX | 93358-3 | (4) | [V] |

DIAPHRAGM OPTIONS PX20X-XXX-XXX-BXXX

| -XXX | ★ Service Kit With Seat | ★ Service Kit Without Seat | ★ "7" | | | ★ "8" | | | ★ "19" (1/8" x 3-5/8" OD) | | |
|------|--|-----------------------------------|-----------|-----|-------|-----------|-----|------|---------------------------|-----|-----|
| | -XXX = (Seat) -XXX = (Ball) -XXX = (Diaphragm) | -XX = (Ball) -XX = (Diaphragm) | Diaphragm | Qty | Mtl | Diaphragm | Qty | Mtl | "O" Ring | Qty | Mtl |
| -XXA | 637309-XXA | 637309-XA | 94329-A | (2) | [Sp] | ----- | --- | --- | 94356 | (4) | [E] |
| -XXB | 637309-XXB | 637309-XB | 94330-A | (2) | [Sp] | ----- | --- | --- | 94356 | (4) | [E] |
| -XXC | 637309-XXC | 637309-XC | 94329-C | (2) | [H] | ----- | --- | --- | Y327-237 | (4) | [V] |
| -XXG | 637309-XXG | 637309-XG | 96330-2 | (2) | [B] | ----- | --- | --- | Y325-237 | (4) | [B] |
| -XXL | 637309-XXL | 637309-XL | 94355-L | (2) | [L] | 94330-A | (2) | [SP] | Y328-237 | (4) | [T] |
| -XXM | 637309-XXM | 637309-XM | 94329-M | (2) | [MSP] | | | | Y328-237 | (4) | [T] |
| -XXT | 637309-XXT | 637309-XT | 94355-T | (2) | [T] | 94330-A | (2) | [SP] | Y328-237 | (4) | [T] |
| -XXV | 637309-XXV | 637309-XV | 95344 | (2) | [V] | ----- | --- | --- | Y327-237 | (4) | [V] |

CENTER SECTION OPTIONS PX20X-XXX-XXX-BXXX

| Item | Description (size) | Qty | Aluminum | | Stainless Steel | |
|--------|------------------------------------|-----|--------------------|------|--------------------|------|
| | | | PX20A-XXX-XXX-BXXX | | PX20S-XXX-XXX-BXXX | |
| | | | Part No. | Mtl | Part No. | Mtl |
| 5 | Backup Washer | (2) | 96503 | [A] | 94357-2 | [SS] |
| 68 | Air Cap | (1) | 94715-1 | [A] | 94349-1 | [SS] |
| 69 | Air Cap | (1) | 94715-2 | [A] | 94349-2 | [SS] |
| 74 | Pipe Plug (1/4 - 18 N.P.T x 7/16") | (2) | Y17-51-S | [SS] | Y17-51-S | [SS] |
| 126 | Plug | (1) | Y17-13-S | [SS] | Y17-13-S | [SS] |
| 131 | Screw (M10 x 1.5 - 6g x 120 mm) | (4) | 94531 | [C] | 96656 | [SS] |
| ★✓ 175 | "O" Ring (3/32" x 1" OD) | (2) | Y325-117 | [B] | ----- | --- |
| ★✓ | (3/32" x 1-1/16" OD) | (2) | ----- | --- | Y325-118 | [B] |
| 181 | Roll Pin (5/32" OD x 3/4" long) | (4) | ----- | --- | Y178-56-S | [SS] |

| MATERIAL CODE | |
|---------------|----------------------------|
| [A] | = Aluminum |
| [B] | = Nitrile |
| [C] | = Carbon Steel |
| [CI] | = Cast Iron |
| [Co] | = Copper |
| [E] | = E.P.R. |
| [H] | = Hytrel |
| [Ha] | = Hastelloy-C |
| [K] | = PVDF |
| [L] | = Long Life PTFE |
| [MSP] | = Medical Grade Santoprene |
| [SH] | = Hard Stainless Steel |
| [SP] | = Santoprene |
| [SS] | = Stainless Steel |
| [T] | = PTFE |
| [V] | = Viton |

MANIFOLD / FLUID CAP MATERIAL OPTIONS PX20X-XXX-XXX-BXXX

| Item | Description (size) | Qty | PX20X-XAX-XXX | | PX20X-XCX-XXX | | PX20X-XHX-XXX | | PX20X-XSX-XXX | | PX20X-FSX-XXX | | PX20X-FHX-XXX | |
|------|--------------------------------------|-----|---------------|-------|---------------|-------|---------------|-------|---------------|-------|---------------|-------|---------------|-------|
| | | | Part No. | [Mtl] | Part No. | [Mtl] | Part No. | [Mtl] | Part No. | [Mtl] | Part No. | [Mtl] | Part No. | [Mtl] |
| 6 | Diaphragm Washer | (2) | 96503 | [A] | 94357-2 | [SS] | 94357-3 | [Ha] | 94357-2 | [SS] | 94357-2 | [SS] | 94357-3 | [Ha] |
| 9 | Washer | (2) | 93065 | [SS] | 93065 | [SS] | 95683 | [Ha] | 93065 | [SS] | 93065 | [SS] | 95683 | [Ha] |
| 14 | Diaphragm Screw (5/8" - 18 x 2-1/2") | (2) | Y5-111-T | [SS] | Y5-111-T | [SS] | 95682 | [Ha] | Y5-111-T | [SS] | Y5-111-T | [SS] | 95682 | [Ha] |
| 15 | Fluid Cap | (2) | 94325 | [A] | 94346 | [CI] | 95679 | [Ha] | 95570 | [SS] | 95570 | [SS] | 95679 | [Ha] |
| 60 | Inlet Manifold | (1) | 94327-[◆] | [A] | 94347-[◆] | [CI] | 95680-[◆] | [Ha] | 95510-[◆] | [SS] | 95512 [◆] | [SS] | 96341 [◆] | [Ha] |
| 61 | Outlet Manifold | (1) | 94326-[◆] | [A] | 94348-[◆] | [CI] | 95681-[◆] | [Ha] | 95511-[◆] | [SS] | 95513 [◆] | [SS] | 96342 [◆] | [Ha] |
| 63 | Pipe Plug (2 - 11-1/2 NPT) | (2) | Y17-128 | [A] | Y17-28-C | [C] | ----- | --- | ----- | --- | ----- | --- | ----- | --- |
| | R 2 (2 - 11 BSP, taper) | (2) | 94439-2 | [A] | 94439-1 | [C] | ----- | --- | ----- | --- | ----- | --- | ----- | --- |

◆ For NPTF thread models (PX20X-AXX-XXX-BXXX) use „-1“.

For BSP thread models (PX20X-BXX-XXX-BXXX) use „-2“.

❖ Flange models

PARTS LIST / PX20X-XXX-XXX-BXXX FLUID SECTION

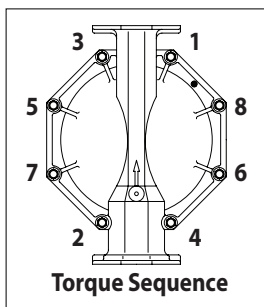

| COLOR CODE | | |
|---------------------|-----------------|------------|
| Material | Diaphragm Color | Ball Color |
| Hytrel | Cream | Cream (+) |
| Nitrile | Black | Red (-) |
| Santoprene | Tan | Tan |
| Santoprene (Backup) | Green | N/A |
| PTFE | White | White |
| Viton | Yellow (-) | Yellow (+) |
| | (-) Dash | (+) Dot |

FOR THE AIR MOTOR SECTION SEE PAGE 7 AND 8.

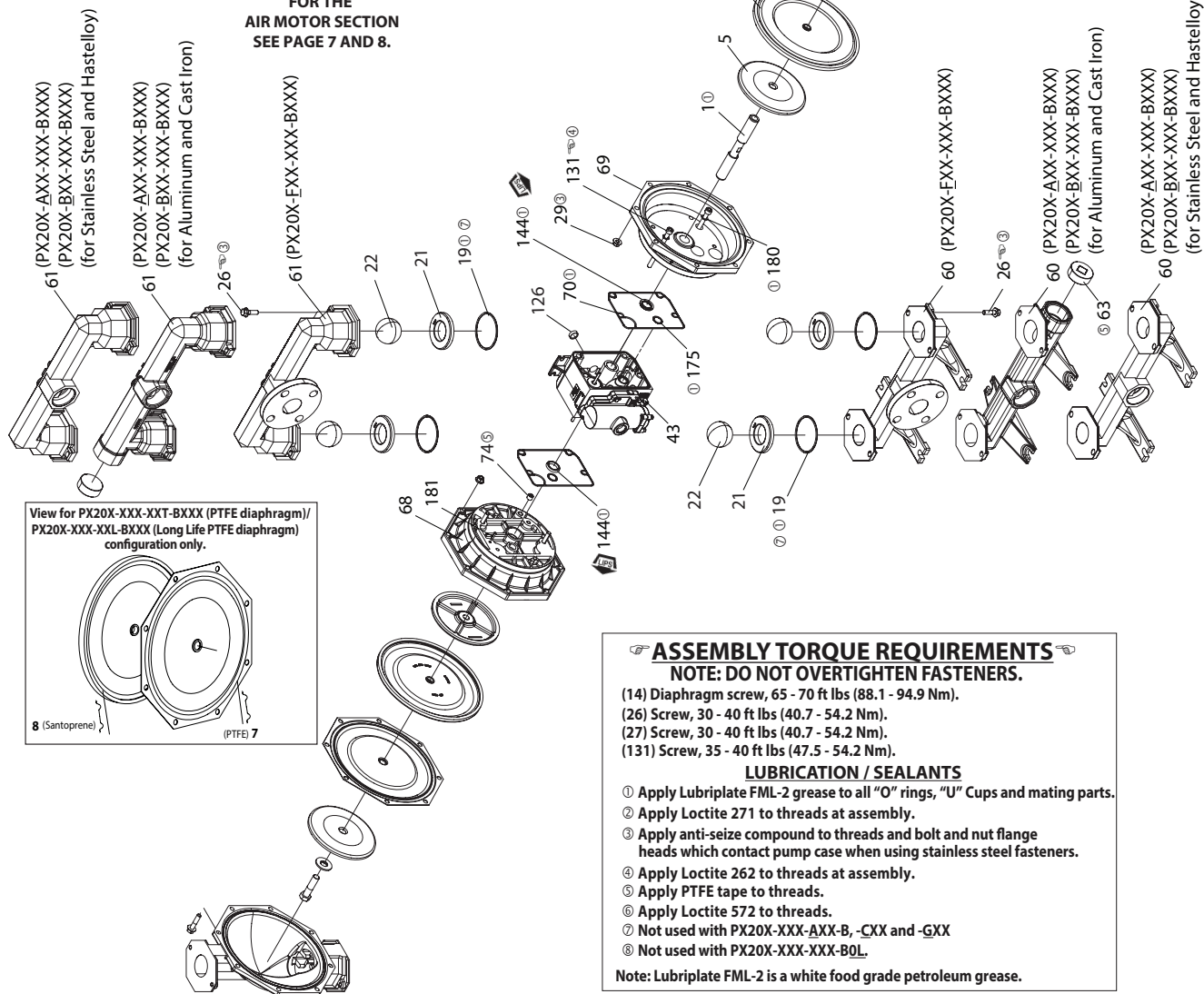

Figure 2

Illinois Location:
 (847) 841-7867
 860 Church Rd Elgin, IL 60120

Minnesota Location:
 (651) 758-7867
 330 Mill Bay South Suite
 Afton, MN 55001

PumpSupplyInc.com

PARTS LIST / PX20X-XXX-XXX-BXXX AIR MOTOR SECTION

⊗ Indicates parts included in 637421 air section service kit shown below and items (70), (144), (175) and (180) shown on page 5.

| Item | Description (size) | Qty | Part No. | Mtl |
|---------|--|-----|------------|-------|
| 101 | Center Body (PX20A-XXX-XXX-BXXX) | (1) | 97031 | [A] |
| | (PX20S-XXX-XXX-BXXX) | (1) | 97040 | [SS] |
| 103 | Bushing | (1) | 97394 | [D] |
| 105 | Screw (M6 x 1 - 6g x 20 mm) | (4) | 95887 | [SS] |
| 111 | Spool | (1) | 95651 | [D] |
| 118 | Actuator Pin (0.250" x 2.276" long) | (2) | 94083 | [SS] |
| 121 | Sleeve | (2) | 94084 | [D] |
| 127 | 90° St. Elbow (1-1/2 - 1-1/2 N.P.T.) | (1) | 94860 | [C/I] |
| 128 | Set Screw (1/4" - 20 x 1/4") | (2) | Y29-42-S | [SS] |
| ⊗ 132 | Gasket | (1) | 94099 | [B] |
| 133 | Lockwasher (1/4") (PX20A-XXX-XXX-BXXX) | (3) | Y117-416-C | [C] |
| | (PX20S-XXX-XXX-BXXX) | (3) | Y14-416-T | [SS] |
| 134 | Screw (M6 x 1 - 6g x 35 mm) | (4) | 95923 | [SS] |
| 135 | Valve Block (PX20A-XXX-XXX-BXXX) | (1) | 96334-1 | [A] |
| | (PX20S-XXX-XXX-BXXX) | (1) | 96337-1 | [SS] |
| 136 | Plug (PX20A-XXX-XXX-BXXX) | (1) | 96335 | [A] |
| | (PX20S-XXX-XXX-BXXX) | (1) | 96339 | [SS] |
| ⊗ 137 | "O" Ring (1/16" x 2" OD) | (1) | Y325-32 | [B] |
| ⊗ 138 | "U" Cup (3/16" x 1.792" OD) | (1) | 95966 | [B] |
| ⊗ 139 | "U" Cup (3/16" x 1-1/4" OD) | (1) | Y186-50 | [B] |
| 140 | Valve Insert | (1) | 95650 | [AO] |
| 141 | Valve Plate | (1) | 95659 | [AO] |
| ⊗ ⊗ 146 | "O" Ring (3/32" x 1-1/16" OD) | (1) | Y325-118 | [B] |
| ⊗ ⊗ 147 | "O" Ring (1/8" x 1/2" OD) | (2) | Y325-202 | [B] |
| ⊗ ⊗ 166 | Track Gasket | (1) | 94026 | [B] |
| ⊗ 167 | Pilot Piston (includes 168 and 169) | (1) | 67164 | [D] |

| Item | Description (size) | Qty | Part No. | Mtl |
|-------|------------------------------------|-----|----------|------|
| 168 | "O" Ring (3/32" x 5/8" OD) | (2) | 94433 | [U] |
| 169 | "U" Cup (1/8" x 7/8" OD) | (1) | Y240-9 | [B] |
| 170 | Piston Sleeve | (1) | 94081 | [D] |
| ⊗ 171 | "O" Ring (3/32" x 1-1/8" OD) | (1) | Y325-119 | [B] |
| ⊗ 172 | "O" Ring (1/16" x 1-1/8" OD) | (1) | Y325-22 | [B] |
| ⊗ 173 | "O" Ring (1/16" x 1-3/8" OD) | (2) | Y325-26 | [B] |
| ⊗ 174 | "O" Ring (1/8" x 1/2" OD) | (2) | Y325-202 | [B] |
| ⊗ 176 | Diaphragm (check valve) | (2) | 94102 | [Sp] |
| ⊗ 199 | Track Gasket | (1) | 95666 | [B] |
| ⊗ 200 | Gasket | (1) | 95665 | [B] |
| 201 | Muffler Kit (includes item 127) | (1) | 67213 | |
| 233 | Adapter Plate (PX20A-XXX-XXX-BXXX) | (1) | 96336 | [A] |
| | (PX20S-XXX-XXX-BXXX) | (1) | 96338 | [SS] |
| 240 | Screw (M6 x 1 - 6g x 16 mm) | (2) | 95991 | [SS] |
| ⊗ 241 | Track Gasket | (1) | 96344 | [B] |
| ⊗ 242 | "O" Ring (1/16" x 7/32" OD) | (1) | Y325-5 | [B] |
| ⊗ 243 | "O" Ring (1/8" x 5/8" OD) | (1) | Y325-204 | [B] |
| ⊗ 244 | "O" Ring (1/8" x 7/8" OD) | (1) | Y325-208 | [B] |
| ⊗ ⊗ | Lubriplate FML-2 grease | (1) | 94276 | |
| | Lubriplate Grease Packets (10) | | 637308 | |

ⓘ Items included in fluid section service kit, see pages 5 and 6.
 ⊗ Used on models PX20S-XXX-XXX-BXXX only.
 ⊗ Used on models PX20A-XXX-XXX-BXXX only.



AIR MOTOR SECTION SERVICE

Service is divided into two parts - 1. Pilot Valve, 2. Major Valve.

GENERAL REASSEMBLY NOTES:

- Air Motor Section service is continued from Fluid Section repair.
- Inspect and replace old parts with new parts as necessary. Look for deep scratches on metallic surfaces, and nicks or cuts in "O" rings.
- Take precautions to prevent cutting "O" rings upon installation.
- Lubricate "O" rings with Lubriplate FML-2 grease.
- Do not over-tighten fasteners. Refer to torque specification block on view.
- Re-torque fasteners following restart.
- SERVICE TOOLS - To aid in the installation of (168) "O" rings onto the (167) pilot piston, use tool # 204130-T, available from ARO.

PILOT VALVE DISASSEMBLY

1. A light tap on (118) actuator pin should expose the opposite (121) sleeve, (167) pilot piston and other parts.
2. Remove (170) sleeve. Inspect inner bore of sleeve for damage.

PILOT VALVE REASSEMBLY

1. Clean and lubricate parts not being replaced from service kit.
2. Install new (171 and 172) "O" rings. Replace (170) sleeve.
3. Install new (168) "O" rings and (169) "U" cup - Note the lip direction. Lubricate and replace (167) pilot piston.
4. Reassemble remaining parts. Replace (173 and 174) "O" rings.

| MATERIAL CODE | |
|---------------|-----------------|
| [A] | = Aluminum |
| [AO] | = Alumina Oxide |
| [B] | = Nitrile |
| [Br] | = Brass |
| [C] | = Carbon Steel |

| MATERIAL CODE | |
|---------------|-------------------|
| [D] | = Acetal |
| [I] | = Iron |
| [SP] | = Santoprene |
| [SS] | = Stainless Steel |
| [U] | = Polyurethane |

MAJOR VALVE DISASSEMBLY

1. Remove (135) valve block and (233) adapter plate, exposing (132 and 166) gaskets and (176) checks.
2. Remove (233) adapter plate, releasing (140) valve insert, (141) valve plate, (199, 200 and 241) gaskets and (243 and 244) "O" rings.
3. Remove (136) plug and (137) "O" ring, releasing (111) spool.

MAJOR VALVE REASSEMBLY

1. Install new (138 and 139) "U" cups on (111) spool - **LIPS MUST FACE EACH OTHER.**
 2. Insert (111) spool into (135) valve block.
 3. Install (137 and 242) "O" rings on (136) plug and assemble plug to (135) valve block, securing with (105) screws.
 4. Install (140) valve insert, (141) valve plate, (199) gasket and (243 and 244) "O" rings into (135) valve block.
- NOTE:** Assemble (140) valve insert with "dished" side toward (141) valve plate. Assemble (141) valve plate with part number identification toward (140) valve insert.
5. Assemble (200 and 241) gaskets and (233) adapter plate to (135) valve block, securing with (240) screws.
 6. Assemble (132 and 166) gaskets and (176) checks to (101) center body.
 7. Assemble (135) valve block and components to (101) center body, securing with (134) screws.

PARTS LIST / PX20X-XXX-XXX-BXXX AIR MOTOR SECTION

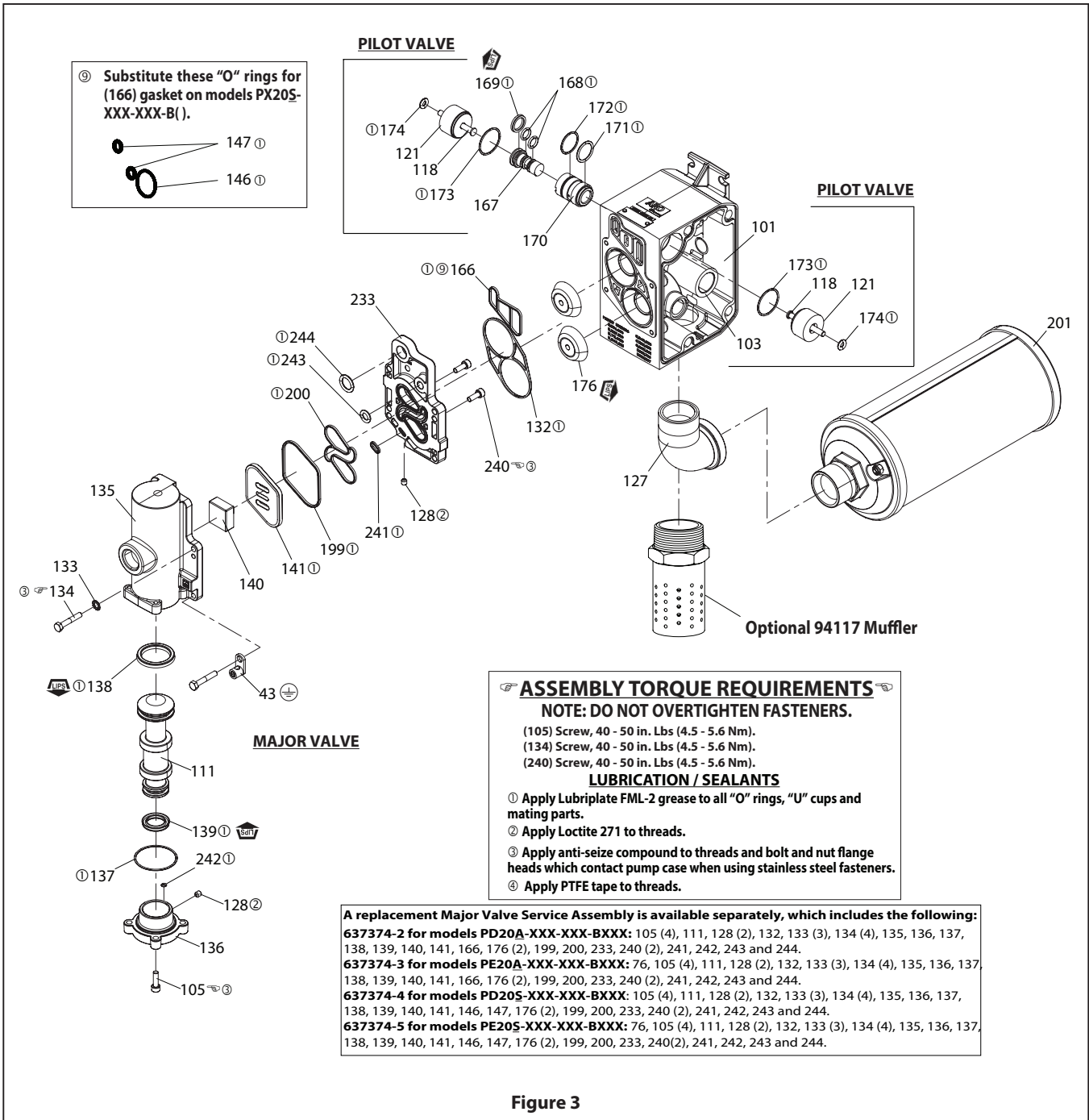

Figure 3

Illinois Location:
 (847) 841-7867
 860 Church Rd Elgin, IL 60120

Minnesota Location:
 (651) 758-7867
 330 Mill Bay South Suite :
 Afton, MN 55001

PumpSupplyInc.com

PS
PUMP SUPPLY
INCORPORATED

TROUBLESHOOTING

Product discharged from exhaust outlet.

- Check for diaphragm rupture.
- Check tightness of (14) diaphragm screw.

Air bubbles in product discharge.

- Check connections of suction plumbing.
- Check "O" rings between intake manifold and inlet side fluid caps.
- Check tightness of (14) diaphragm screw.

Motor blows air or stalls.

- Check (176) check valve for damage or wear.
- Check for restrictions in valve / exhaust.

Low output volume, erratic flow or no flow.

- Check air supply.
- Check for plugged outlet hose.
- Check for kinked (restrictive) outlet material hose.
- Check for kinked (restrictive) or collapsed inlet material hose.
- Check for pump cavitation - suction pipe should be sized at least as large as the inlet thread diameter of the pump for proper flow if high viscosity fluids are being pumped. Suction hose must be a non-collapsing type, capable of pulling a high volume.
- Check all joints on the inlet manifolds and suction connections. These must be air tight.
- Inspect the pump for solid objects lodged in the diaphragm chamber or the seat area.

DIMENSIONAL DATA

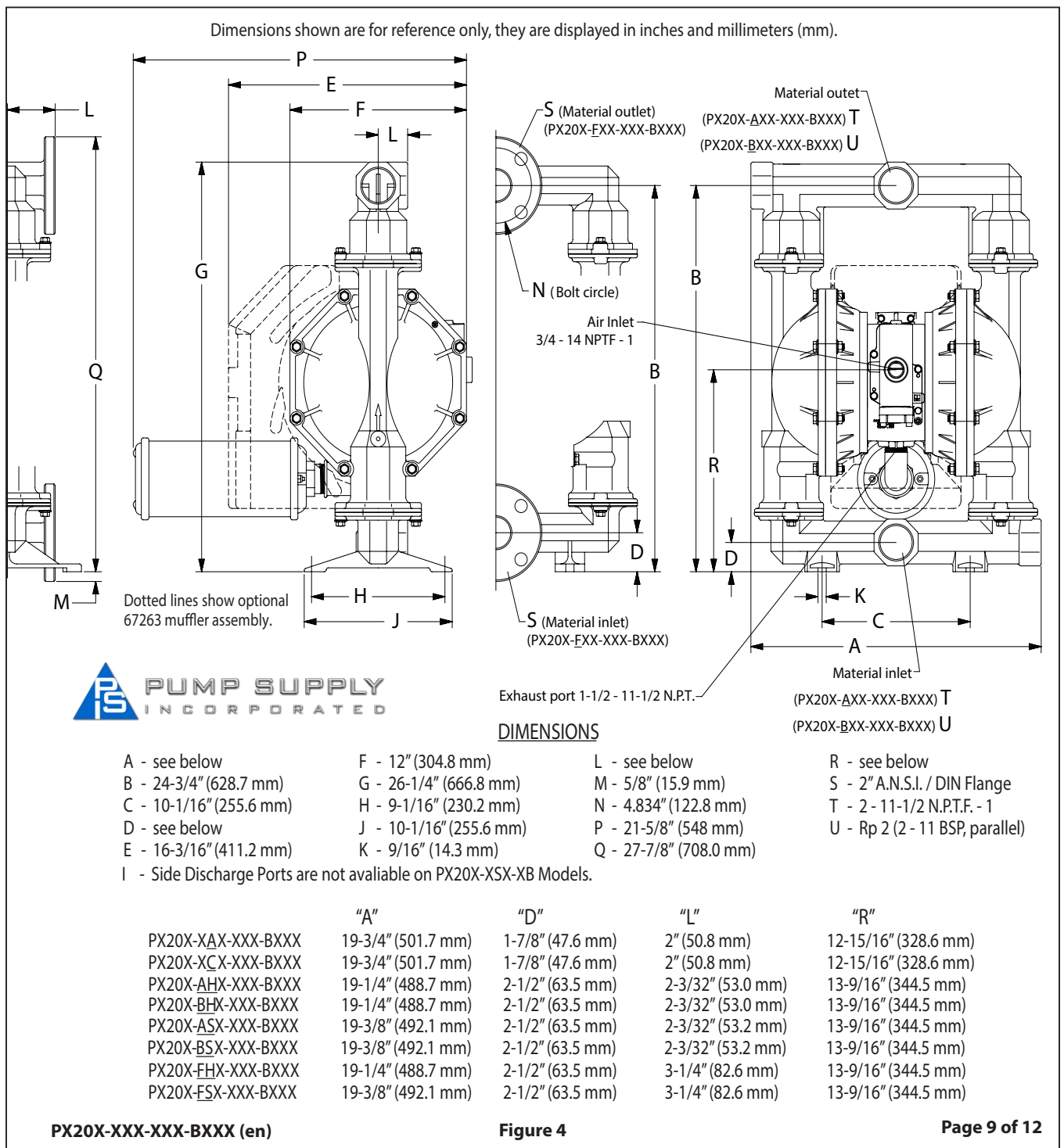

Illinois Location:
(847) 841-7867
860 Church Rd Elgin, IL 60120

Minnesota Location:
(651) 758-7867
330 Mill Bay South Suite
Afton, MN 55001

PumpSupplyInc.com





The complex block contains contact information for two locations. On the left, the Illinois location is listed with phone number (847) 841-7867 and address 860 Church Rd Elgin, IL 60120. Below it, the Minnesota location is listed with phone number (651) 758-7867 and address 330 Mill Bay South Suite, Afton, MN 55001. The website PumpSupplyInc.com is listed at the bottom left. On the right, there is a map of the United States with stars marking the locations in Illinois and Minnesota. Below the map is the Pump Supply Incorporated logo, which consists of a blue triangle containing the letters 'P' and 'S' in white, followed by the text 'PUMP SUPPLY' in a large, bold, sans-serif font, and 'INCORPORATED' in a smaller, spaced-out, sans-serif font below it.

Illinois Location:
(847) 841-7867
860 Church Rd Elgin, IL 60120

Minnesota Location:
(651) 758-7867
330 Mill Bay South Suite
Afton, MN 55001

PumpSupplyInc.com



The complex block contains contact information for two locations. On the left, the Illinois location is listed with phone number (847) 841-7867 and address 860 Church Rd Elgin, IL 60120. Below it, the Minnesota location is listed with phone number (651) 758-7867 and address 330 Mill Bay South Suite, Afton, MN 55001. The website PumpSupplyInc.com is listed at the bottom left. On the right, there is a map showing the outlines of Illinois and Minnesota. A star is placed in the western part of Illinois, and another star is placed in the western part of Minnesota. Below the map is the company logo, which consists of a blue triangle containing the letters 'P' and 'S' in white, followed by the text 'PUMP SUPPLY INCORPORATED' in a bold, sans-serif font.

Illinois Location:
(847) 841-7867
860 Church Rd Elgin, IL 60120

Minnesota Location:
(651) 758-7867
330 Mill Bay South Suite
Afton, MN 55001

PumpSupplyInc.com



The image shows a map of the United States with two stars indicating office locations: one in Illinois and one in Minnesota. Below the map is the Pump Supply Incorporated logo, which consists of a blue triangle containing the letters 'P' and 'S' in white, followed by the text 'PUMP SUPPLY INCORPORATED' in a bold, sans-serif font.