

# SENTRY™

PULSATION & SURGE CONTROL



## Installation and Operation Manual Inlet Stabilizer Dampener Models

**SENTRY dampeners are pressure vessels** containing a flexible bladder or bellows inside that separates an inert pressurized gas (air or Nitrogen) from a system fluid in the lower chamber. Depending on how dampeners are configured, they are used as **Pulsation Dampeners, Inlet Stabilizers or Surge Suppressors** to control pressure fluctuations and spikes in liquid piping systems.

Dampeners work on the principle that volume is inversely proportional to pressure ( $P_1V_1=P_2V_2$ ). Compressed air or Nitrogen (never Oxygen) is introduced into the non-wetted side of the dampener. The gas charge is contained by the bladder or bellows preventing contact between the system fluid and the gas.

When the dampener is sized correctly, properly installed and charged according to the instructions provided it will greatly reduce the damaging effects of pressure variations in piping systems and significantly improve the efficiency of transferring liquids.

**All dampeners manufactured by BLACOH use pressure bodies made in the USA to insure quality. Prior to shipment, each and every dampener is factory tested at design pressure or higher to assure proper function and leak-free operation.**

Go to [www.blacoh.com](http://www.blacoh.com) for literature in multiple languages.

**BLACOH™**  
FLUID CONTROL

## Table of Contents

<b>SAFETY Warnings .....</b>	<b>2</b>
Safety Symbols .....	2
General Safety .....	2
Equipment Misuse Hazard .....	3
<b>GENERAL Information .....</b>	<b>3</b>
Must Read Before Installation .....	3
Installation Notes.....	4
ATEX Standard .....	4
Maintenance.....	4
Temperature Limits .....	5
<b>Installation &amp; Operation Instructions: INLET SABILIZER Models.....</b>	<b>6</b>
Pre-Charge Notes .....	6
Installation for Pump Inlet.....	6
<b>Manufacturer’s Limited Warranty &amp; Return Policy.....</b>	<b>10</b>

## MODEL Specifications & Installation Information

Model No.	Serial No.	Installation Date
/		
Body Material: Wetted / Non-wetted	Bladder/Bellows Material	Pump Area and Number
Purchased From	Contact	Phone
		Email

The word “dampener”, as used in this Manual, has the same meaning as Pulsation Dampener, Inlet Stabilizer or Surge Suppressor.

Copyright © 2012 BLACOH Fluid Controls, Inc. All rights reserved.

Information in this document is subject to change without notice. No part of this publication may be reproduced, stored in a retrieval system or transmitted in any form or by any means electronic or mechanical, including photocopying and recording for any purpose other than the purchaser’s personal use without the express written permission of BLACOH Fluid Controls, Inc.

## SAFETY Warnings

Dampeners should only be installed, operated and repaired by experienced and trained professional mechanics. Read and observe all instructions and safety warnings in this Manual before installing, operating or repairing dampeners.

### Safety Symbols

The following symbols indicate cautions, warnings and notes that must be observed for safe and satisfactory installation, operation and maintenance of dampener.



#### WARNINGS

Danger of serious injury or death could occur if these warnings are ignored.



#### CAUTIONS

Equipment damage, injury or death could occur if these cautions are not observed.



#### NOTES

Special instructions for safe and satisfactory installation, operation and maintenance.

### General Safety



#### CAUTION!

- Observe all safety symbols in installation and operation instructions.
- The internal dampener pressure will equal the maximum fluid pressure of the system in which it is installed.
- **DO NOT** exceed maximum allowable working pressure (MAWP) specified on dampener serial tag or marked on dampener. If serial tag is missing, **DO NOT** use dampener without consulting distributor or factory for maximum pressure rating.
- Always make sure safety shutoff valves, regulators, pressure relief valves, gauges, etc. are working properly before starting system or assembly.
- Verify dampener model received against purchase order and shipper.
- Before starting a system or assembly make certain the discharge point of the piping system is clear and safe, and all persons have been warned to stand clear.
- **DO NOT** put your face or body near dampener when the system or assembly is operating or dampener is pressurized.
- **DO NOT** operate a dampener that is leaking, damaged, corroded or otherwise unable to contain internal fluid, air or gas pressure.
- **DO NOT** pump incompatible fluids through dampener. Consult distributor or factory if you are not sure of the compatibility of system fluids with dampener materials.
- Dampeners are designed to operate with compressed air or clean dry Nitrogen **only**. Other compressed gases have not been tested and may be unsafe to use. **DO NOT USE OXYGEN.**
- Always shut off air supply, remove internal dampener pressure and shut dampener isolation valve before performing dampener maintenance or repair.
- Remove all pressure from dampener AND pumping system before disassembly, removal or maintenance.
- **Static spark can cause an explosion resulting in severe injury or death. Ground dampeners and pumping system when pumping flammable fluids or operating in flammable environments.**
- **NOTE:** EC standard EN-13463-1 and EN-13463-5 (ATEX) require grounding (earthing) on dampeners when the potential for static sparking is present. A grounding point is located and marked on ATEX specific dampener models.

## Equipment Misuse Hazard

### CAUTION!

#### General Safety

**DO NOT** misuse dampener, including but not limited to over-pressurization, modification of parts, using incompatible chemicals, or operating with worn or damaged parts. **DO NOT** use any gases other than compressed air or clean dry Nitrogen to charge dampener. **DO NOT USE OXYGEN.** Any misuse could result in serious bodily injury, death, fire, explosion or property damage.

#### Over-Pressurization

Never exceed the maximum pressure rating for the dampener model being used. Maximum allowable working pressure (MAWP) is specified on dampener serial tag or marked on dampener. Maximum allowable working pressure (MAWP) is rated at 70°F (21°C).

#### Temperature Limits

**DO NOT** exceed the operating temperature limits for the body and/or elastomer materials being used. Excessive temperature will result in dampener failure. For temperature limits, refer to the "Temperature Limits" section of this Manual. Temperature limits are stated at zero psi/bar.

#### Installation and Start-Up Hazards

Install dampener before charging or pressurizing. **DO NOT** start system or assembly without first charging or pressurizing dampener. Failure to charge may result in damage to the elastomeric bladder or PTFE bellows.

#### Temperature & Pressure Hazard

Temperature and pressure reduce the strength and chemical resistance of plastic, metal, elastomers and PTFE.

#### Charging / Pressurization

Charge or pressurize dampener with compressed air or clean dry Nitrogen only. **DO NOT USE OXYGEN.**

#### Dampener Bladder/Bellows Failure

Dampeners utilize an elastomeric membrane (bladder) or PTFE bellows to separate system fluid from the air supply or gas charge. When failure occurs, system fluid may be expelled from the air valve. Always perform preventive maintenance and replace bladder/bellows before excessive wear occurs. O-rings for PTFE bellows cannot be re-used.

#### Maintenance Hazards

Never over-tighten fasteners. This may cause leakage of system fluid and damage to dampener body. Bolts on metal models should not be reused as re-torquing reduces bolt strength. **After maintenance or re-assembly of metal models, use new fasteners and torque fasteners according to specification on dampener tag.**

## GENERAL Information



For safe and satisfactory operation of dampener read all safety warnings, caution statements and this complete Manual before installation, startup, operation or maintenance.

## Must Read Before Installation



**DO NOT** use Oxygen to charge dampener. Use compressed air or clean dry Nitrogen only.



**DO NOT** exceed maximum allowable working pressure (MAWP) specified on dampener serial tag or marked on dampener.



Turn pump off and remove all pressure from system prior to dampener installation.



Always wear safety glasses and other appropriate safety equipment when installing, charging or repairing dampener.



**Danger of static spark!** Grounding precautions must be considered when dampener is used in flammable or explosive environments.



ATEX models must be grounded (earthed) before operation.



**DO NOT** operate a dampener that is leaking, damaged, corroded or otherwise unable to contain internal fluid, air or gas pressure.







Temperature, pressure and chemicals affect the strength of plastic, elastomer and metal components.



Many plastics lose strength rapidly as temperature increases. Consult factory if in doubt.

## Installation Notes

-  Dampening of flow pulsations can only be effective if 5 to 10 psi (0.4 to 0.7 bar) back pressure downstream of dampener is available. A BLACOH back pressure valve may be required downstream of dampener.
-  It is recommended that a BLACOH pressure relief valve be installed in all pump systems to ensure compliance with pressure limits on system equipment.
-  To avoid possible damage to bladder/bellows from a system pressure test:  
**Adjustable and Chargeable models** — charge dampener to 80% of the system test pressure prior to test.  
**Automatic models** — dampener must be equipped with a constant source of compressed air prior to test; connect a compressed air line and dampener will pressurize itself.
-  Install dampener in-line as close to the pump discharge/inlet or quick closing valve as possible. Dampener installation should be no more than ten pipe diameters from pump discharge/inlet or quick closing valve.
-  It is recommended that an isolation valve be installed between the dampener and system piping.

## ATEX Standard

-  Certain models made for the European market comply with the ATEX standard for use in potentially explosive atmospheres. These models have the AT designation at the end of the part number and comply with EC standard EN-13463-5 with protection degree of II 2GD TXC. AT models have a grounding lug and must be grounded (earthed) before operation.

## Maintenance



**Remove all pressure from dampener AND pumping system before disassembly, removal or maintenance.**

Dampeners require very little maintenance. There is only ONE wear part – the elastomeric bladder or the PTFE bellows. There is no need for lubrication.

Elastomeric bladder replacement should be part of a preventive maintenance program. Dampeners used in conjunction with diaphragm pumps should have the bladders replaced at least every second time the diaphragms in the pump are replaced. As with any pumping system, wear is dependent on many factors including material, temperature, chemicals, fluid abrasiveness and system design. This suggested maintenance program may need to be adjusted according to specific applications.

Periodic inspection of the dampener and fasteners should be conducted to visually check for signs of over-pressurization, fatigue, stress or corrosion. Body housings and fasteners must be replaced at first indication of deterioration.



**CAUTION! Replace nut and bolt fasteners on metal models at each re-assembly with fasteners of equal grade/strength value. DO NOT re-use old nuts and bolts.**

After the initial torque of fasteners, bolts will usually lose up to 20% of their strength when re-torqued. Failure to replace both nuts and bolts upon each vessel reassembly will void the product warranty given by the manufacturer and the manufacturer will have no liability whatsoever for any vessel failure or malfunction.

Where dampeners are used in corrosive environments, nut and bolt fasteners should be regularly inspected and replaced with nut and bolt fasteners of equal grade/strength value if corrosion is observed. Failure to conduct such regular inspections and replacement will void the product warranty given by the manufacturer and the manufacturer will have no liability whatsoever for any vessel failure or malfunction.



**IMPORTANT!** After maintenance or re-assembly of metal models, use new fasteners and torque fasteners according to specification on dampener tag.



**DO NOT** use dampener if the fasteners (nuts and bolts) are corroded. Check for fastener corrosion frequently, especially in atmospheres containing salt or corrosive chemicals, or if dampener leakage has occurred.

## Temperature Limits

**!** Operating temperatures are based on the maximum temperature of the wetted dampener components only. Non-wetted dampener components may have a lower temperature limit. Temperature and certain chemicals may reduce the maximum allowable working pressure (MAWP) of the dampener.

Elastomer Materials	Temperature Limits	Applications
Aflas	0°F to +400°F (-18°C to +204°C)	High temperature, petroleum based chemicals, strong acids and bases.
Buna	+10°F to +180°F (-12°C to +82°C)	Good flex life; use with petroleum, solvents and oil-based fluids.
FDA Buna	+10°F to +180°F (-12°C to +82°C)	FDA-approved food grade; similar characteristics of regular Buna.
EPDM	-60°F to +280°F (-51°C to +138°C)	Use in extreme cold; good chemical resistance with ketones, caustics.
Hypalon	-20°F to +275°F (-29°C to +135°C)	Excellent abrasion resistance; good in aggressive acid applications.
Neoprene	0°F to +200°F (-18°C to +93°C)	Good abrasion resistance and flex; use with moderate chemicals.
PTFE	+40°F to +220°F (+4°C to +104°C)	Bellows design; excellent flex life; use with highly aggressive fluids.
Santoprene	-20°F to +225°F (-29°C to +107°C)	Excellent choice as a low cost alternative for PTFE in many applications.
FDA Silicone	-20°F to +300°F (-29°C to +149°C)	FDA-approved food grade material; for use in food and pharmaceutical processing.
USP Class VI Silicone	-20°F to +300°F (-29°C to +149°C)	Pharmaceutical grade material; for use in food and pharmaceutical processing.
Viton®	-10°F to +350°F (-23°C to +177°C)	Use in hot and aggressive fluids; good with aromatics, solvents, acids and oils.

**!** **CAUTION!** Plastic materials lose strength as temperature increases which reduces the maximum pressure sustainable by the material.

Non-Metallic Body Materials	Temperature Limits	Applications
Acetal*	+32°F to +175°F (0°C to +79°C)	Good flex life; low moisture sensitivity; high resistance to solvents and chemicals.
CPVC	+32°F to +180°F (0°C to +82°C)	Chlorinated PVC (CPVC) retains strength to higher temperatures.
Noryl	+32°F to +220°F (0°C to +104°C)	Good resistance to acids and bases; good temperature stability.
Polypropylene*	+32°F to +175°F (0°C to +79°C)	Good general purpose plastic; broad chemical compatibility at medium temperatures.
PTFE	+40°F to +220°F (+4°C to +104°C)	Use with highly aggressive fluids.
PVC	See chart below.	Good general chemical resistance; loses strength quickly as temperature rises.
PVDF	+10°F to +200°F (-12°C to +93°C)	Excellent resistance to most acids and bases; highest temperature plastic available.

\* Conductive Acetal and Conductive Polypropylene available.

**!** **CAUTION!** PVC loses strength more rapidly than other plastic materials as temperature increases. Certain chemicals can also affect material strength reducing maximum pressure ratings. The chart below shows reduced maximum pressure ratings based on temperature for PVC only. Note that these are general guidelines only; selection of dampener materials must be determined by each individual application to avoid equipment damage and unsafe operation.

<b>!</b> PVC Maximum Pressure Guidelines by Temperature							
Temperature	73.4°F (23° C)	80°F (27°C)	90°F (32°C)	100°F (38°C)	110°F (43°C)	120°F (48°C)	130°F (54°C)
Maximum Pressure	150 psi (10.3 bar)	142.5 psi (9.8 bar)	135 psi (9.3 bar)	112.5 psi (7.6 bar)	97.5 psi (6.7 bar)	90 psi (6.2 bar)	75 psi (5.2 bar)



## Installation & Operation Instructions: INLET SABILIZER Models

- ❗ Inlet Stabilizer dampener models are for use on the inlet side of pumps only.
- ❗ ATEX models must be grounded (earthed) before operation.
- ⚠ Turn pump off and remove all pressure from system prior to dampener installation.
- ⚠ Remove all pressure from dampener AND pumping system before disassembly, removal or maintenance.
- ⚠ Use compressed air to charge dampener. **DO NOT USE OXYGEN.**
- ⚠ **DO NOT exceed 30 psi (2 bar) maximum allowable working pressure (MAWP) to prevent damage to the compound pressure gauge. Check maximum pressure rating specified on dampener serial tag.**
- ⚠ Before performing a system pressure test, dampener must be charged with 80% of system test pressure, not to exceed 30 psi (2 bar), to avoid possible damage to bladder/bellows.
- ⚠ Always wear safety glasses and other appropriate safety equipment when installing, charging or repairing dampener.
- ⚠ Read and observe all safety warnings and instructions in this Manual before installation, operation or repair.
- ⚠ **IMPORTANT! After maintenance or re-assembly of metal models, use new fasteners and torque fasteners according to specification on dampener tag.**
- ⚠ To properly adjust an Inlet Stabilizer dampener model, a compound pressure gauge must be installed in the pump inlet piping.

### Pre-Charge Notes

Read Before Installation

Pre-charge pressure should be checked at least monthly as gas molecules will diffuse through elastomeric bladders, the speed of which depends on the elastomer material, temperature and pressure. Checks must occur when no system pressure is present or inaccurate readings will be recorded. If temperature is above 72°F (22°C) and/or pressure is over 300 psi (20.7 bar), checks should be performed more frequently. **To prevent pre-charge loss through the fill valve, always replace the fill valve cap after charging.** A proper gas charge is the key to dampener effectiveness and bladder/bellows life.

### Installation for Pump Inlet

Read Before Installation

#### Step 1 — Installation Position

Install the dampener in-line as close to the pump inlet as possible and after any upstream equipment such as risers, valves, elbows, meters or filters. Dampener installation should be no more than ten pipe diameters from pump inlet. If using a flexible connector on the inlet side of the pump between the system piping and pump, the dampener should be installed on a tee at the pump inlet manifold. The flexible connector should be attached to the dampener's tee and system piping (see FIGURE 1). A compound pressure gauge should be installed upstream of the dampener to aid in proper dampener adjustment.

#### Step 2 — Charging and Start-Up (see Pre-Charge Notes)

Inlet Stabilizer dampener models do not require an air line connection.

- A. **Suction Lift/Negative Inlet Pressure Application:** Follow the steps below to make required adjustments. Pump must be running before adjusting dampener.
  1. Close the ball valve (Part ② on FIGURE 2).
  2. Turn the pump on and observe the changes in pressure on the compound pressure gauge at the pump inlet (FIGURE 1).
  3. Attach a compressed air line with an air chuck (not included) to the venturi valve (Part ① on FIGURE 2).
  4. Open the ball valve. As compressed air flows through the venturi valve, observe the compound pressure gauge (Part ③ on FIGURE 2) on the dampener. As soon as the gauge reads 5" to 6" Hg vacuum (-0.17 to 0.20 bar), close the ball valve. If the ball valve is left open too long while adding compressed air pressure to the venturi valve, the

bladder/bellows will be drawn all the way up to the top of the dampener. This will eliminate the vacuum pull of the bladder/bellows making the dampener less effective. If this occurs, turn the pump off, add 10 psi (0.7 bar) pressure to the dampener to push the bladder/bellows back down, and repeat steps 1 through 4.

5. The vacuum observed on the dampener's compound pressure gauge (Part ③ on FIGURE 2) should read approximately the same as that on the inlet pipe's compound gauge, and needle fluctuations should now be minimal. The vacuum may need to be adjusted up or down to obtain minimum movement on the inlet pipe's compound gauge.

**B. Positive Inlet Pressure:** Pre-charge the dampener with 50%, not to exceed 30 psi (2 bar), of the static system pressure realized at the pump inlet. Start the pump to generate working pressure. Minor pressure adjustments may be required. Allow the system to respond to each adjustment (this may take a minute or two) before making further adjustments. Follow the steps below to make required adjustments.

1. Close the ball valve (Part ② on FIGURE 2).
2. Attach a compressed air line with an air chuck (not included) to the venturi valve (Part ① on FIGURE 2).
3. Open the ball valve.
4. With a finger partially covering the exhaust air from the bottom of the venturi valve, watch the compound pressure gauge on the dampener (Part ③ on FIGURE 2) until it reaches 50%, not to exceed 30 psi (2 bar), of static inlet pressure. Close the ball valve.



To prevent damage to the compound pressure gauge, **DO NOT** exceed 30 psi (2 bar) maximum allowable working pressure (MAWP).

FIGURE 1

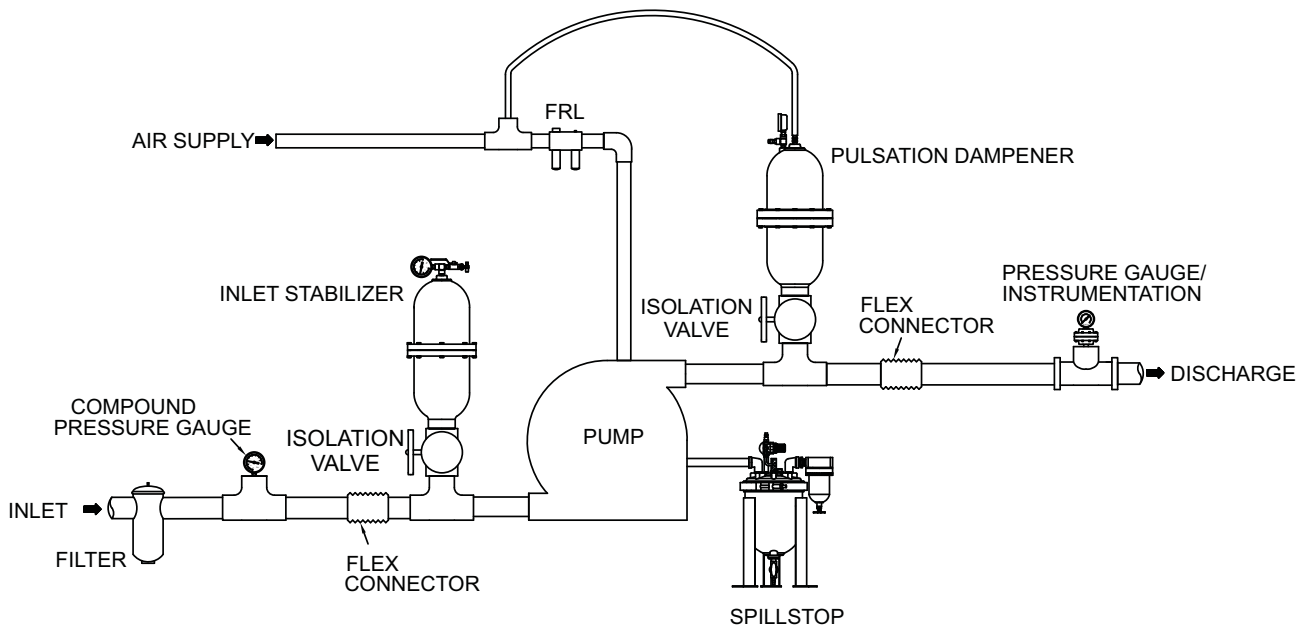



**FIGURE 2**

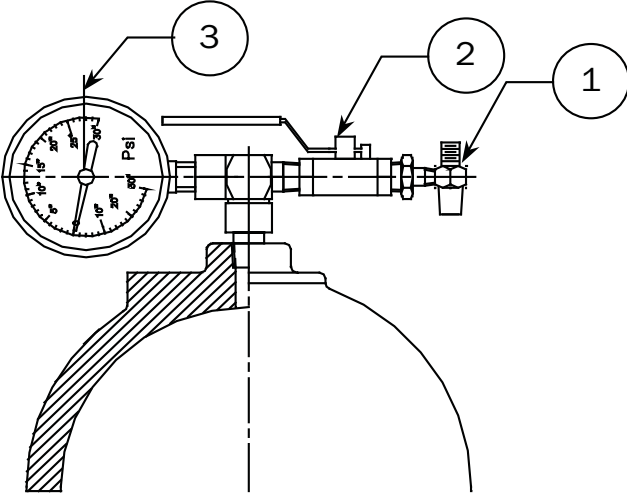



## **Manufacturer's Limited Warranty & Return Policy**

### **Standard Product Limited Warranty**

Subject to the limitations set forth below, BLACOH Fluid Controls, Inc. ("BLACOH") warrants its products to be free from defects in material and workmanship under normal use, service, and maintenance in accord with BLACOH's published specifications for a period of two years from date of shipment by BLACOH (the "Warranty"). The EXCLUSIVE REMEDY for any product defect covered under this Warranty shall be one of the following, as determined by BLACOH in BLACOH's sole discretion: (a) refund of the purchase price; or (b) replacement or repair of the defective part or parts at BLACOH's facility. This Warranty will be null and void if the product is used in an inappropriate application or if the product has been altered, misapplied, improperly installed, or not properly inspected and maintained. To the maximum extent allowed by applicable law, BLACOH will not be responsible for nor have any liability for any "Damage," which means any of the following, whether the claim sounds in breach of contract, breach of warranty, tort, strict liability, implied contractual indemnity, or otherwise: (i) any damage, loss, or injury of any kind, or destruction, or death, whether or not caused by any defect in a BLACOH product and whether or not the BLACOH product is installed, used, operated, and/or maintained in accord with BLACOH instructions, to other products, machinery, buildings, property, or persons, and (ii) any costs, expenses, losses, or incidental, consequential, or special damages of any kind or nature, including but not limited to loss of profits, arising from or related to any BLACOH product, whether or not caused by any defect in a BLACOH product and whether or not the BLACOH product is installed, used, operated, and/or maintained in accord with BLACOH instructions. Damage resulting from chemical incompatibility or from over-pressurization of a product, whether from gas or fluid, is not covered under this Warranty, nor will BLACOH be responsible in any way for any such Damage. Because BLACOH does not determine and cannot anticipate or control the many different conditions under which its products may be used, BLACOH does not warrant the applicability, suitability, or fitness of any of its products for any particular use or purpose. Statements concerning the possible use of BLACOH products are not intended and shall not be interpreted as warranties of fitness for any specific use of such products. Each user of BLACOH products must conduct its own engineering analysis and tests to determine the suitability of each BLACOH product for the user's intended uses or purposes, including but not limited to chemical compatibility and pressurization, and any written or oral assistance from BLACOH in this regard does not relieve the user from exclusive responsibility for such engineering analysis and testing. BLACOH products are sold with only this limited Warranty, and each buyer assumes all responsibility for Damage (as defined above), including but not limited to, Damage arising from defects in BLACOH products and/or from the handling and use of BLACOH products whether used in accordance with BLACOH's directions or otherwise. Any products sold by BLACOH which are manufactured by and sold under the name of another company are NOT WARRANTED by BLACOH under the foregoing Warranty or otherwise. The buyer must rely exclusively on the product warranty, if any, given by such other company. Products manufactured by BLACOH as an original equipment manufacturer (OEM) to be sold by a customer under the customer's brand and name are warranted by BLACOH only under the above Warranty, and BLACOH shall have no liability whatsoever with respect to any representation or warranty given by such customer (or such customer's representatives, distributors, agents, employees, or independent contractors) to any of its buyers which is different in any respect whatsoever from the foregoing Warranty. EXCEPT FOR THE WARRANTY GIVEN ABOVE, WHICH IS SUBJECT TO THE ADDITIONAL LIMITATIONS STATED ABOVE, AND EXCEPT FOR THE ADDITIONAL LIMITED WARRANTY ON BLACOH'S PTFE BELLOWS STATED BELOW, BLACOH GIVES NO WARRANTY OF ANY NATURE WHATSOEVER, EXPRESS OR IMPLIED, WITH RESPECT TO ANY OF ITS PRODUCTS, INCLUDING WITHOUT LIMITATION NO WARRANTY OF MERCHANTABILITY AND NO WARRANTY OF FITNESS FOR A PARTICULAR PURPOSE. NO COURSE OF DEALING, USAGE OF TRADE, OR OTHER ORAL OR WRITTEN STATEMENTS SHALL MODIFY THE FOREGOING WARRANTY PROVISIONS AND LIMITATIONS IN ANY RESPECT WHATSOEVER. This Warranty shall be governed by and construed in accordance with the laws of the State of California.

### **PTFE Bellows Limited Warranty**

In addition to BLACOH's Standard Product Limited Warranty and subject to the limitations set forth below, BLACOH warrants that its PTFE Bellows equipment ("PTFE Bellows") on BLACOH's PTFE Bellows-fitted pulsation dampener will perform in accordance with BLACOH's written product description for three years from date of shipment ("PTFE Bellows Warranty"). This PTFE Bellows Warranty applies only to PTFE Bellows that are sized, charged, installed, used, operated, and maintained strictly in accordance with all installation, use, operation, and maintenance instructions provided by BLACOH, and failure to properly size, charge, install, use, operate, and maintain the PTFE Bellows (or failure to do any of them) shall make the PTFE Bellows Warranty null and void. This PTFE Bellows Warranty does not include applications where failure of performance is due to an unbalanced pressure load or a transient pressure spike (sometimes called a water hammer). The EXCLUSIVE REMEDY for breach of this PTFE Bellows Warranty is replacement of the PTFE Bellows at BLACOH's facility, and not any other equipment or parts whatsoever, and BLACOH will not be responsible for any Damage or any other loss of any kind, including but not limited to incidental, consequential, or special damages (including but not limited to loss of profits), in any way arising from failure of the PTFE Bellows to perform in accordance with BLACOH's written product description. This PTFE Bellows Warranty shall be governed and construed in accordance with the laws of the State of California.

## Warranty Claims

1. Prior to returning any product to BLACOH based on a claim of breach of Warranty or PTFE Bellows Warranty, a BLACOH Return Request form must be completed. The form will be reviewed by BLACOH to determine if a Return Merchandise Authorization (RMA) number will be issued. The issuance of an RMA number does not constitute BLACOH's acknowledgment or agreement that the warranty claim is justified or correct.
2. If an RMA number is issued by BLACOH, customer should then deliver the product in question to the address specified on the RMA, freight prepaid.
3. All products so returned to BLACOH based on a claim of breach of Warranty or of PTFE Bellows Warranty must be cleaned, sanitized and neutralized prior to shipment to BLACOH. BLACOH will not accept any part that contains corrosive chemicals, organic cultures, blood, any harmful residue or air borne materials that might contaminate a breathable atmosphere or put at risk any person or property. Any shipment that does not comply will be returned at the expense of the customer, or the customer will be required to arrange for pickup.
4. HAZMAT SHIPMENTS WILL BE REMOVED AND PROCESSED AT CUSTOMER'S EXPENSE.
5. Receipt by BLACOH of a return does not constitute BLACOH's agreement that BLACOH is in breach of its Warranty or PTFE Bellows Warranty.
6. If BLACOH determines that a defect in workmanship or material of a part has occurred, customer is not entitled to a complete unit replacement. In the event of such a defect, BLACOH will repair or replace the defective part or parts or refund the purchase price, as BLACOH determines in BLACOH's sole discretion.

## New Product Returns

1. If a customer wishes to return a new, unused product, the customer must first request a Return Merchandise Authorization (RMA) number from BLACOH. BLACOH will determine if the unit can be returned for possible credit.
2. Product to be returned must be new, unused, and of current design and purchased within thirty (30) days of the return request. In addition the product must not have been damaged after original shipment by BLACOH.
3. Product returns must be delivered, freight prepaid.
4. BLACOH has the right to inspect all returned products prior to acceptance or rejection.
5. ALL RETURNS are subject to a minimum \$50.00 or 30% restocking fee, whichever is greater. (Higher restocking fees may be charged on special items and some models may not be eligible for return). Returns accepted by BLACOH will be credited to the customer's account less the re-stocking fee. Refunds will not be issued.
6. Any outsourced product supplied by BLACOH will be subject to the warranty, return policy and re-stock fee charged by the manufacturer of the outsourced product.

[L11E11\_060]



### **BLACOH Fluid Control**

601 Columbia Ave, Bldg D  
Riverside, CA 92507 USA

Phone: 951.342.3100  
800.603.7867

Fax: 951.342.3101

Email: [Sales@BLACOH.com](mailto:Sales@BLACOH.com)

[www.BLACOH.com](http://www.BLACOH.com)