



HTW 300

3" x 2-1/2" End Suction Centrifugal Hot Water Pump

The HTW 300 is a patented, unique centrifugal pump specifically designed for high temperature process manufacturing applications using hot water, ethylene glycol, propylene glycol and triethylene glycol. The Tempuflo HTW Series utilizes an isolated seal chamber, which is effectively cooled by both a cooling loop (heat exchanger) and by a fan clamp which couples the unit to the shaft of a standard NEMA C Face frame motor.

The isolator technology combined with the heat exchanger allows the seal cavity to reach a maximum and seal chamber temperature of 170°F (77°C) while the process temperature is at 400°F (204°C). This lower seal temperature greatly increases seal life, which means less down time for the end user.

Discharge port location can be provided as either Horizontal or Vertical position.



Application

- Industrial
- OEM

SPECIFICATIONS:

Suction And Discharge	3" x 2-1/2" ANSI 150# flat flange
Materials Of Construction	Ductile iron
Flow	Up to 500 GPM
Head Feet	Up to 190'
Impeller	7.0" cast iron, enclosed
Motor	Up to 20 HP
Drive Options	Close coupled 184TC, Close coupled 215TC, Pedestal, PumPAK® (without motor)
Seal	Carbon / silicon carbide / Viton

Illinois Location:

(847) 841-7867
860 Church Rd Elgin, IL 60120

Minnesota Location:

(651) 758-7867
330 Mill Bay South Suite
Afton, MN 55001

PumpSupplyInc.com



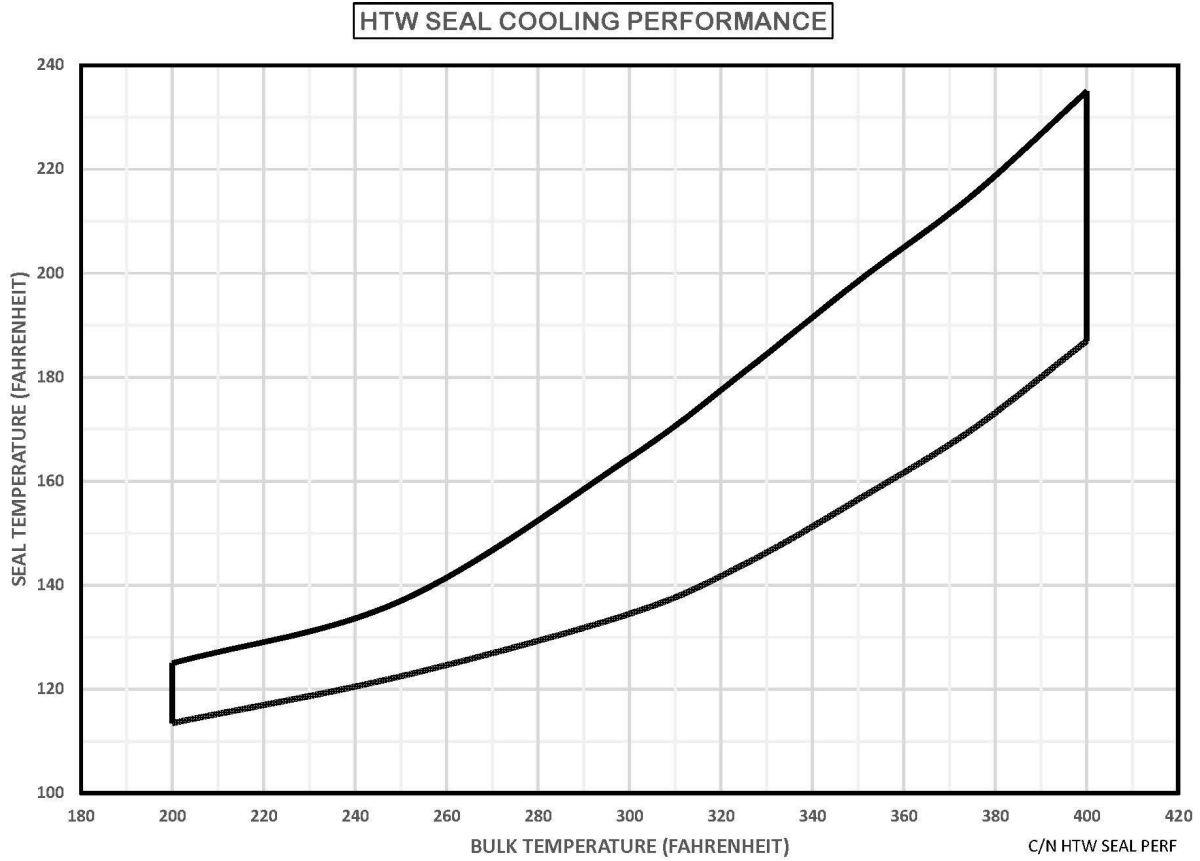

Illinois Location:
 (847) 841-7867
 860 Church Rd Elgin, IL 61

Minnesota Location:
 (651) 758-7867
 330 Mill Bay South Suite
 Afton, MN 55001

PumpSupplyInc.com



PS **PUMP SUPPLY**
 INCORPORATED



HTW Pressure Temperature Limits

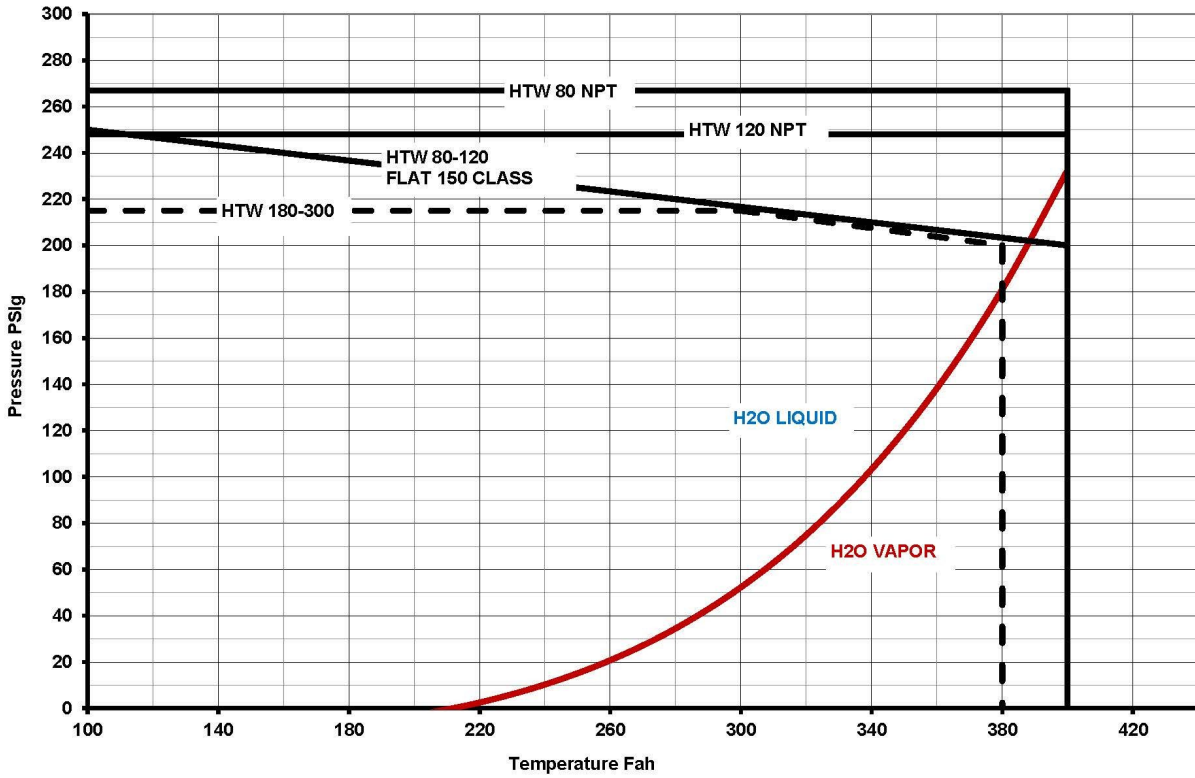

Illinois Location:

(847) 841-7867
860 Church Rd Elgin, IL 61

Minnesota Location:

(651) 758-7867
330 Mill Bay South Suite
Afton, MN 55001

PumpSupplyInc.com

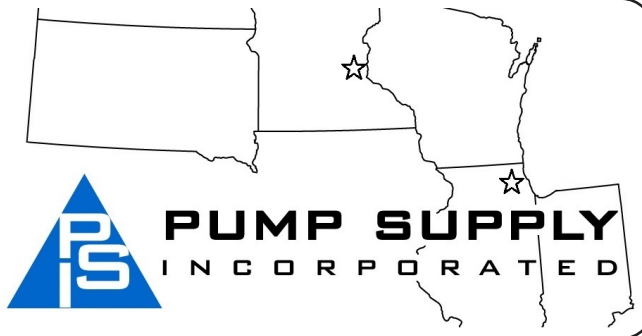

HTW 300

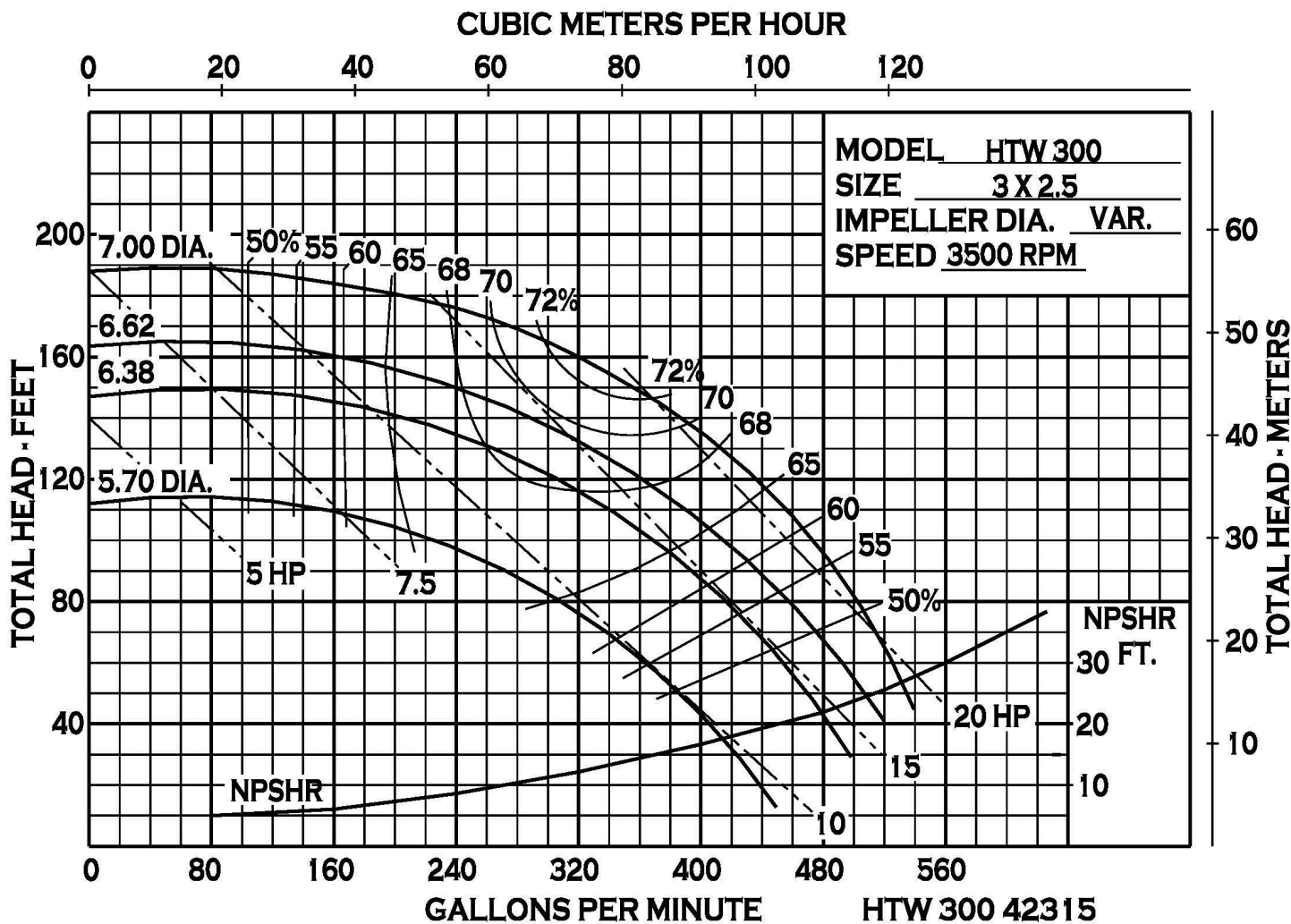

Illinois Location:

(847) 841-7867
 860 Church Rd Elgin, IL 61

Minnesota Location:

(651) 758-7867
 330 Mill Bay South Suite
 Afton, MN 55001

PumpSupplyInc.com

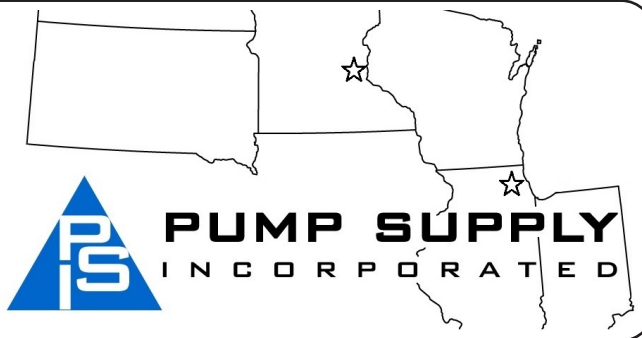

36636

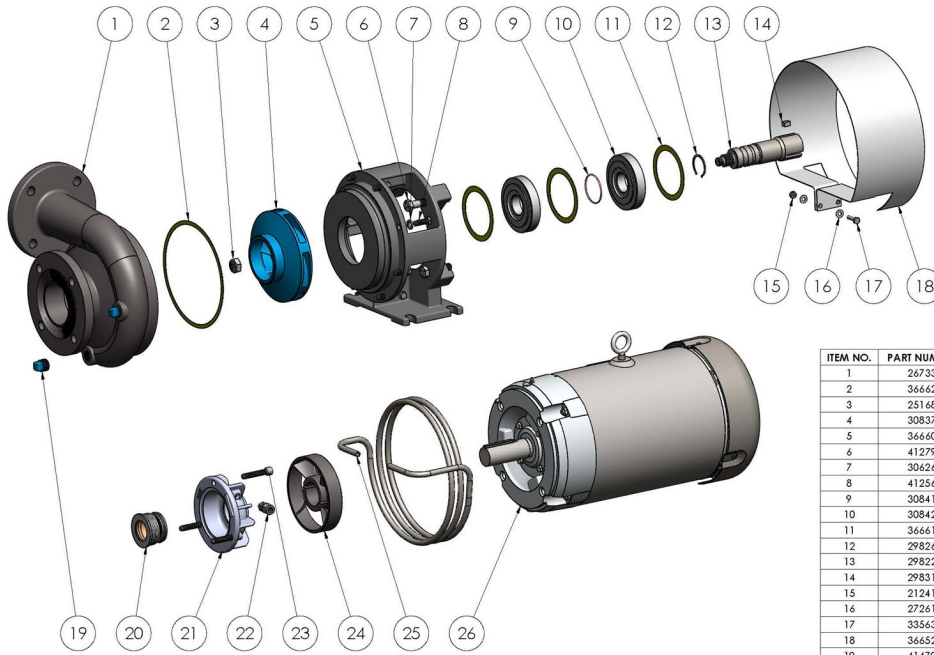

ITEM NO.	PART NUMBER	DESCRIPTION	MATERIAL	QTY.
1	24733	HOUSING	DUCTILE IRON	1
2	34662	GASKET	KLINGER TOP-SIL	1
3	25168	HEX JAM NUT 5/8-18	STEEL	1
4	30837	IMPELLER	CAST IRON	1
5	34660	ADAPTOR	DUCTILE IRON	1
6	41279	CAPSCREW 1/2-13X2	STEEL	4
7	30626	LOCKWASHER	STEEL	8
8	41256	CAPSCREW 3/8-16X1	STEEL	8
9	30841	O-RING	VITON	1
10	30842	ISOLATOR	CG	2
11	34661	GASKET	KLINGER TOP-SIL	3
12	29826	SNAP RING	STEEL	1
13	29822	DRIVE SLEEVE	303 STAINLESS STEEL	1
14	29831	SQUARE KEY	STEEL	1
15	21241	HEXNUT 1/4-20	304 STAINLESS STEEL	2
16	27261	WASHER	STEEL	4
17	33563	CAPSCREW 1/4-20X1	304 STAINLESS STEEL	2
18	34652	SHIELD	STEEL	1
19	41479	PIPE PLUG 1/2 NPT	CAST IRON	2
20	34933	SEAL ASSEMBLY	CSC/VITON	1
21	34639	HOUSING SEAL	DUCTILE IRON	1
22	34644	ADP FITTING	304 STAINLESS STEEL	2
23	39600	CAPSCREW 3/8-16X2	304 STAINLESS STEEL	3
24	29833	CLAMP FAN ASSEMBLY	DUCTILE IRON/STEEL	1
25	34635	HE COIL	304 STAINLESS STEEL	1
26	31294	ELECTRIC MOTOR	TEFC	1

NOTE: THIS DRAWING IS THE PROPERTY OF MP PUMPS, INC. CONSULTING ENGINEERS AND CONTRACTORS. IT IS TO BE USED ONLY AS APPROVED BY MP PUMPS. NO PARTS ARE TO BE COPIED, REPRODUCED OR OTHERWISE USED WITHOUT THE WRITTEN CONSENT OF MP PUMPS. RETURN TO MP PUMPS PROMPTLY WHEN REQUESTED.

MP PUMPS, INC.
FRANK, MICHIGAN 48026, U.S.A.

DATE: 4/27/15
HTW300PMP D:20-3 215TC 6.62

36636

Illinois Location:

(847) 841-7867
860 Church Rd Elgin, IL 61

Minnesota Location:

(651) 758-7867
330 Mill Bay South Suite
Afton, MN 55001

PumpSupplyInc.com

