



HTW 180

3" x 1-1/2" End Suction Centrifugal Hot Water Pump

HTW 180 is a patented, unique centrifugal pump specifically designed for high temperature process manufacturing applications using hot water, ethylene glycol, propylene glycol and triethylene glycol. The Tempuflo HTW Series utilizes an isolated seal chamber, which is effectively cooled by both a cooling loop (heat exchanger) and by a fan clamp which couples the unit to the shaft of a standard NEMA C Face frame motor.

The isolator technology combined with the heat exchanger allows the seal cavity to reach a maximum and seal chamber temperature of 170°F (77°C) while the process temperature is at 400°F (204°C). This lower seal temperature greatly increases seal life, which means less down time for the end user.

Discharge port location can be provided as either Horizontal or Vertical position.



Application

- Industrial
- OEM

SPECIFICATIONS:

Suction And Discharge	3" x 1-1/2" ANSI 150# flat flange
Materials Of Construction	Ductile iron
Flow	Up to 320 GPM
Head Feet	Up to 162'
Impeller	6.45"
Motor	Up to 10 HP
Drive Options	Close coupled 184TC, Close coupled 215TC, Pedestal, PumPAK® (without motor)
Seal	Carbon / silicon carbide / Viton

Illinois Location:

(847) 841-7867
860 Church Rd Elgin, IL 60120

Minnesota Location:

(651) 758-7867
330 Mill Bay South Suite 100
Afton, MN 55001

PumpSupplyInc.com

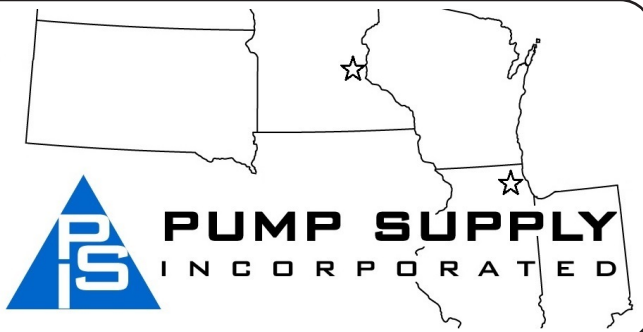

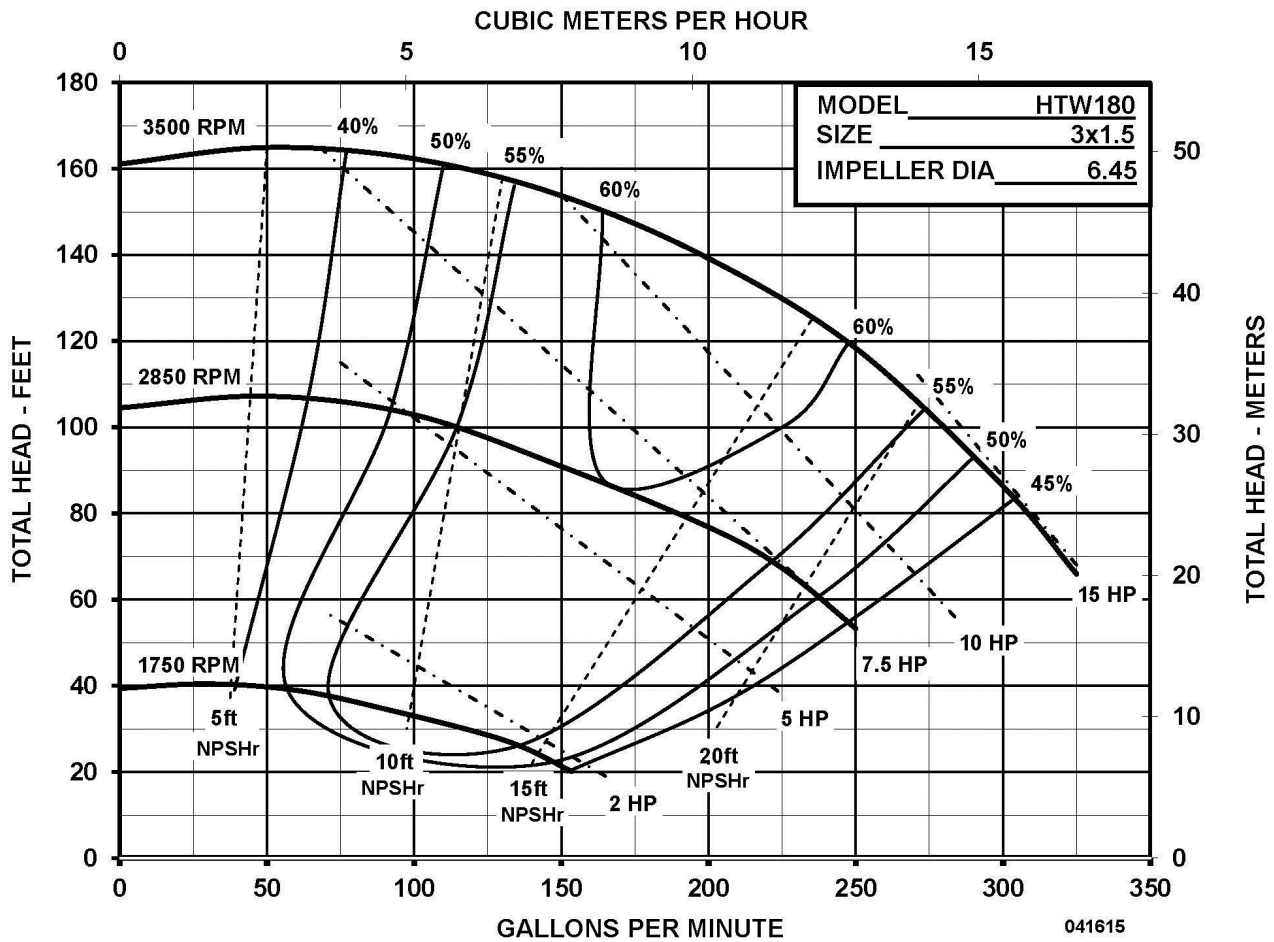

Illinois Location:
 (847) 841-7867
 860 Church Rd Elgin, IL 61

Minnesota Location:
 (651) 758-7867
 330 Mill Bay South Suite :
 Afton, MN 55001

PumpSupplyInc.com



PS
PUMP SUPPLY
 INCORPORATED

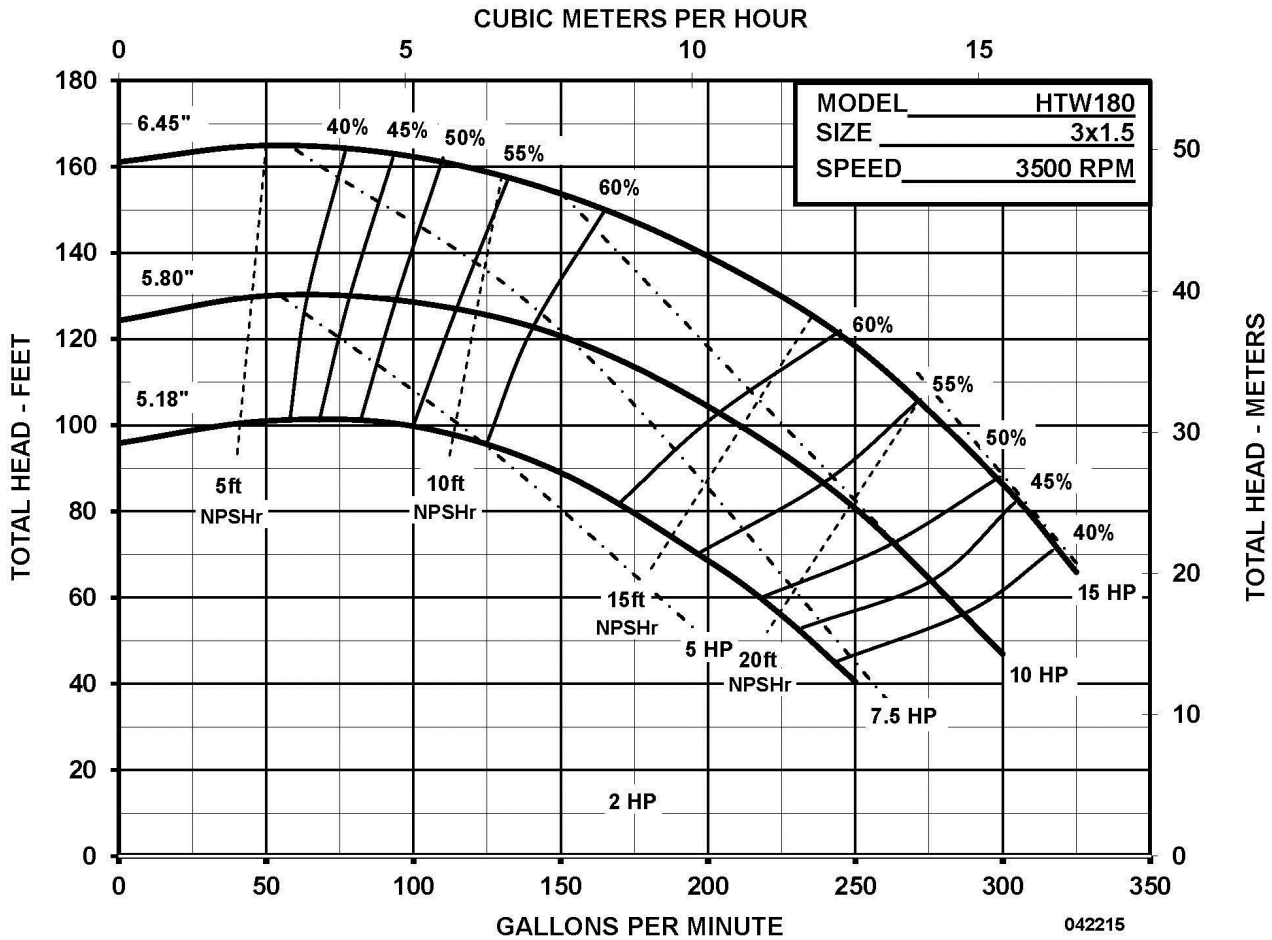

Illinois Location:

(847) 841-7867
 860 Church Rd Elgin, IL 61

Minnesota Location:

(651) 758-7867
 330 Mill Bay South Suite :
 Afton, MN 55001

PumpSupplyInc.com



HTW SEAL COOLING PERFORMANCE

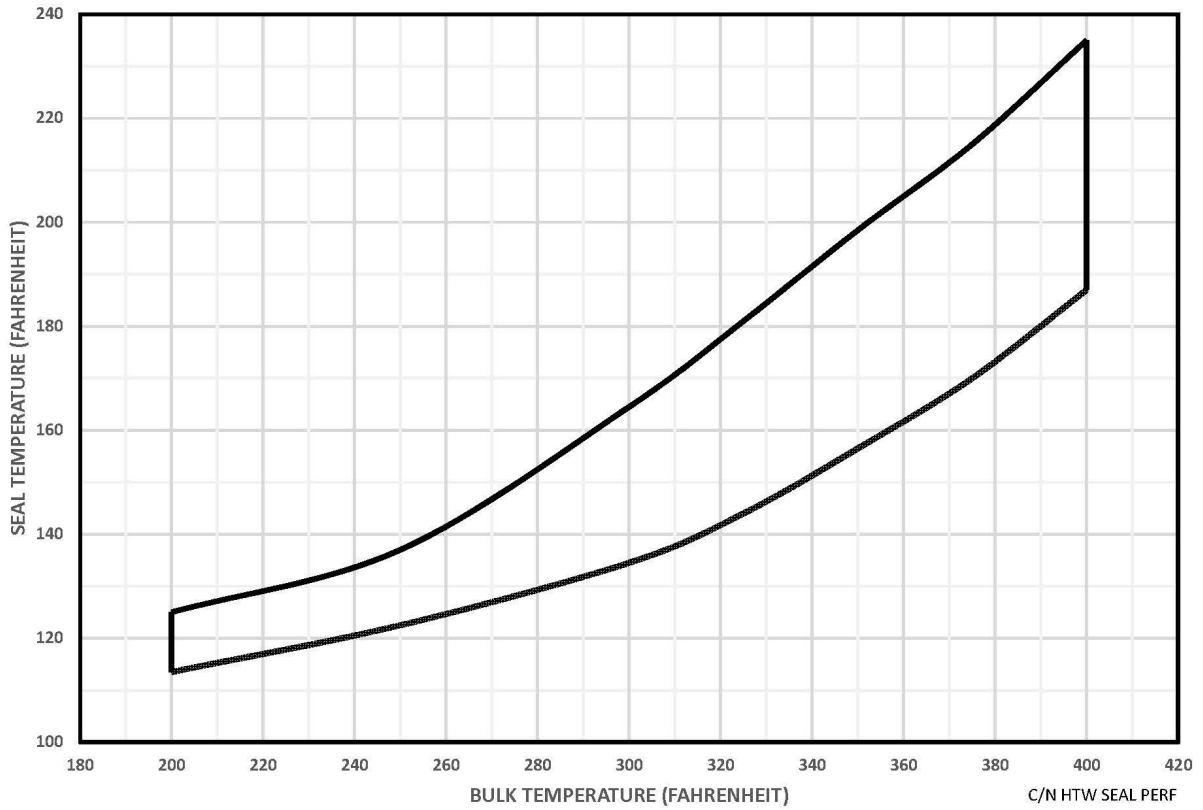

Illinois Location:
 (847) 841-7867
 860 Church Rd Elgin, IL 60120

Minnesota Location:
 (651) 758-7867
 330 Mill Bay South Suite :
 Afton, MN 55001

PumpSupplyInc.com



PS **PUMP SUPPLY**
INCORPORATED



HTW Pressure Temperature Limits

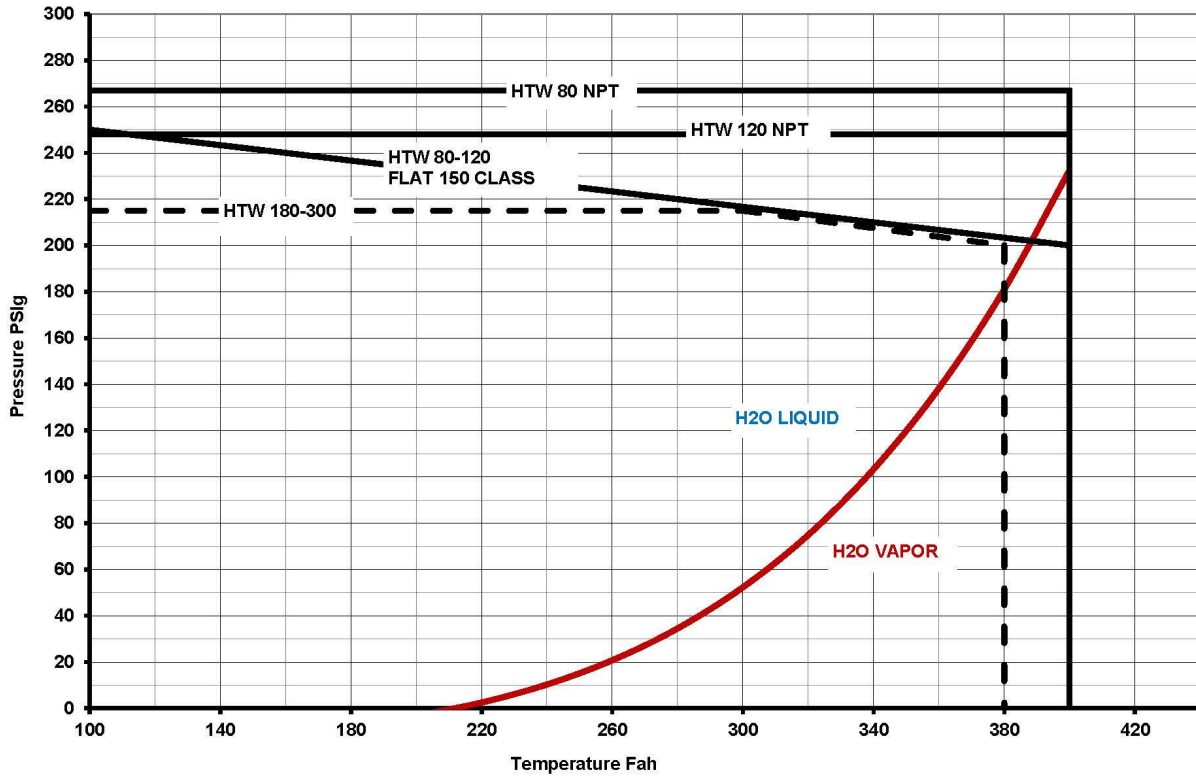

Illinois Location:

(847) 841-7867
860 Church Rd Elgin, IL 61

Minnesota Location:

(651) 758-7867
330 Mill Bay South Suite :
Afton, MN 55001

PumpSupplyInc.com



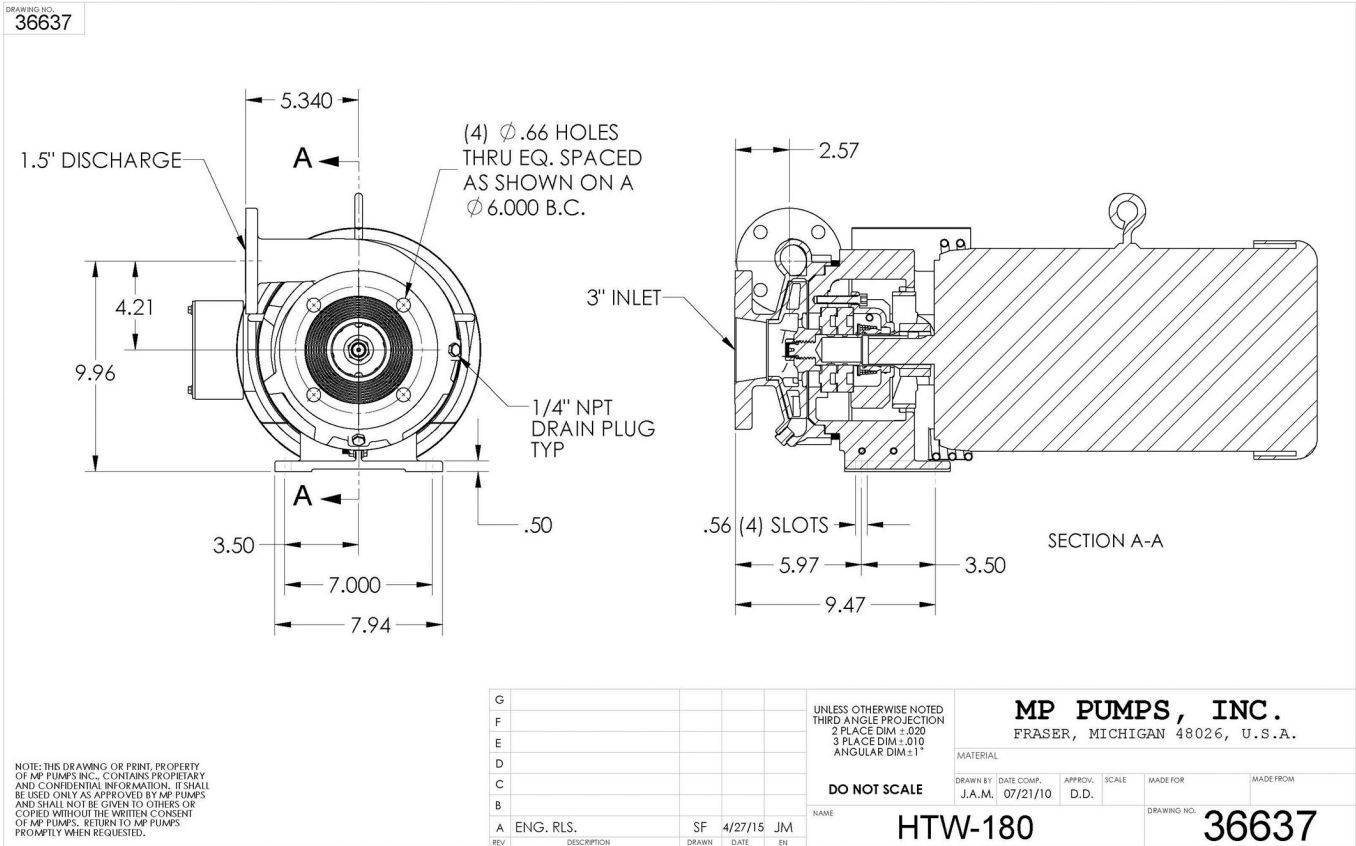

Illinois Location:
(847) 841-7867
860 Church Rd Elgin, IL 61

Minnesota Location:
(651) 758-7867
330 Mill Bay South Suite :
Afton, MN 55001
PumpSupplyInc.com

PUMP SUPPLY INCORPORATED



36637

ITEM NO.	PART NUMBER	DESCRIPTION	MATERIAL	QTY.
1	33503	HOUSING	DUCTILE IRON	1
2	36662	GASKET	KLINGER TOP-SIL	1
3	25168	HEX JAM NUT 5/8-18	STEEL	1
4	33505	IMPELLER	DUCTILE IRON	1
5	30626	LOCKWASHER	STEEL	8
6	41256	CAPSCREW 3/8-16X1	STEEL	8
7	36656	ADAPTOR	DUCTILE IRON	1
8	41279	CAPSCREW 1/2-13X2	STEEL	4
9	30842	ISOLATOR	CG	2
10	36661	GASKET	KLINGER TOP-SIL	3
11	30841	O-RING	VITON	1
12	29826	SNAP RING	STEEL	1
13	29822	DRIVE SLEEVE	303 STAINLESS STEEL	1
14	29831	SQUARE KEY	STEEL	1
15	21241	HEXNUT 1/4-20	304 STAINLESS STEEL	2
16	27261	WASHER	STEEL	4
17	33563	CAPSCREW 1/4-20X1	304 STAINLESS STEEL	2
18	36652	SHIELD	STEEL	1
19	41475	PIPE PLUG; 1/4 NPT	STEEL	2
20	34933	SEAL ASSEMBLY	CSC/VITON	1
21	36639	HOUSING SEAL	DUCTILE IRON	1
22	39800	CAPSCREW 3/8-16X2	304 STAINLESS STEEL	3
23	36646	ADP FITTING	304 STAINLESS STEEL	2
24	29833	CLAMP FAN ASSEMBLY	DUCTILE IRON/STEEL	1
25	36635	HE COIL	304 STAINLESS STEEL	1
26	30384	ELECTRIC MOTOR	TEFC	1

NOTE: THE DRAWING OR PRINT PROPERTY OF MP PUMPS, INC. CONTAINS PROPRIETARY AND CONFIDENTIAL INFORMATION. IT SHALL BE USED ONLY AS APPROVED BY MP PUMPS, INC. AND SHALL NOT BE GIVEN TO OTHERS OR COPIED, REPRODUCED, OR TRANSMITTED IN ANY FORM OR BY ANY MEANS, WITHOUT THE WRITTEN CONSENT OF MP PUMPS, INC. RETURN TO MP PUMPS PROMPTLY WHEN REQUESTED.

UNLESS OTHERWISE NOTED THIRD ANGLE PROJECTION
 1. PLACE DIM + 0.00
 2. PLACE DIM ± .010
 3. ANGULAR DIM ± 1°

DO NOT SCALE

MP PUMPS, INC.
 FRASER, MICHIGAN 48026, U.S.A.

DRAWN BY: DATE: 10/9/14
 S.J. D.D.

NAME: HTW180PMP D:1.5-3 21.5TC 6.5 CSC

DRAWING NO: 36637

Illinois Location:
 (847) 841-7867
 860 Church Rd Elgin, IL 61

Minnesota Location:
 (651) 758-7867
 330 Mill Bay South Suite :
 Afton, MN 55001

PumpSupplyInc.com

