



MODEL: G 1304T

OPERATING INSTRUCTIONS, INSTALLATION & MAINTENANCE MANUAL INCLUDING SPARE PARTS LIST



Illinois Location:

(847) 841-7867
860 Church Rd Elgin, IL 60120

Minnesota Location:

(651) 758-7867
330 Mill Bay South Suite 100
Afton, MN 55001

PumpSupplyInc.com





LIFE IS PRECIOUS - THINK SAFETY

1. Most accidents can be avoided by using COMMON SENSE.
2. Please read the operation and maintenance instruction manual supplied with the pump. If you did not receive one, please call your local distributor before pump installation.
3. Do not wear loose apparel that may become entangled in the impeller or other moving parts.
4. Always use appropriate safety equipment, such as safety glasses, when working on the pump or piping.
5. Pumps build up heat and pressure during operation-allow time for pumps to cool before handling or servicing.
6. Only qualified service personnel should install, operate and repair pump.
7. Keep clear of suction and discharge openings. DO NOT insert fingers in pump with power connected.
8. Do not pump flammable or hazardous materials (gasoline, acids, alkalis, etc.)
9. Do not block or restrict discharge hose, as it may whip or burst catastrophically under pressure.
10. Make sure lifting handles/hooks are securely fastened each time before lifting.
11. Do not lift pump by the power cord under any circumstances.
12. Do not exceed manufacturer's recommendation for optimum performance, as this could cause the motor/pump to overheat and lead to premature wear or failure.
13. Secure the pump in its operating position so it does not tip over, fall or slide.
14. Keep away from impeller when power is connected.
15. Submersible Pumps are not approved for use in swimming pools, recreational water installations, decorative fountains or any installation where human contact with the pumped fluid is common.
16. Do not operate pump without adequate protection and safety devices in place.
17. Always replace safety devices that have been removed during service or repair.
18. To reduce risk of electrical shock, pump must be properly grounded in accordance with the National Electric Code and all applicable state and local codes and ordinances.
19. To reduce risk of electrical shock, always disconnect the pump from the power source before handling or servicing.
20. Any wiring of pumps should be performed by a qualified electrician.
21. Never operate a pump with a power cord that has frayed or brittle insulation.
22. Cable should be protected at all times to avoid punctures, cuts, and abrasions - inspect frequently.
23. Never handle connected - "hot" power cords with wet hands.
24. Never operate a pump with a plug-in type power cord without a ground fault circuit interrupter, adequate overload and short circuit protection.

IMPORTANT !!! MODY Pumps Inc. is not responsible for losses, injury, or death resulting from a failure to observe these safety precautions, misuse or abuse of pumps or equipment.



ISO 9001 Certified

INTRODUCTION

THE **"mody"** ELECTRIC DRIVEN PORTABLE SUBMERSIBLE PUMPS HAVE BEEN DEVELOPED DUE TO A LONG FELT NEED OF HAVING A TRULY MAINTENANCE FREE PUMPSET FOR VARIOUS APPLICATIONS. THE PUMP IS A LIGHTWEIGHT, COMPACT UNIT ENABLING IT TO BE USED IN MOST SEA-CRAFT AND DIFFICULT LAND INSTALLATIONS. THE UNIT CONSISTS OF A VERTICAL CENTRIFUGAL PUMP WITH AN IN-BUILT SQUIRREL CAGE, INDUCTION ELECTRIC MOTOR WHICH IS AVAILABLE FOR VARIOUS ELECTRIC SUPPLY CONFIGURATIONS. THE PUMPED WATER IS USED AS A COOLING MEDIUM WHICH COOLS THE ELECTRIC MOTOR. THE PUMPSET CAN ALSO BE USED IN ANY POSITION THUS MAKING IT IDEAL FOR DEWATERING IN DIFFICULT LOCATIONS.

THE SERVICE LIFE OF A SUBMERSIBLE PUMP DEPENDS MAINLY ON TWO THINGS: THE DEPENDABILITY OF THE SEALING SYSTEM AND THE WEAR RESISTANCE OF THE PUMP WEAR PARTS.

ALL **"mody"** SUBMERSIBLE SUMP PUMPS INCORPORATE A UNIQUE SEALING SYSTEM. THE CONSTRUCTION CONSISTS OF TWO MECHANICAL SEALS, ARRANGED IN TANDEM, IMMERSSED IN AN OIL BATH. THE COMPLETE PACKAGE IS A PRESSURE COMPENSATED SEALING DEVICE WHICH ENSURES A MINIMAL PRESSURE DIFFERENTIAL ACROSS THE SEAL FACES, IRRESPECTIVE OF THE DEPTH SETTING OF THE PUMP OR THE HEAD AGAINST WHICH THE PUMP IS OPERATING.

IN **"mody"** SUBMERSIBLE SUMP PUMPS, ALL WEAR PARTS ARE RUBBER LINED/COVERED AND ARE READILY REPLACEABLE AS NEEDED. BOTH WEAR AND ELECTRICITY CONSUMPTION ARE STILL FURTHER REDUCED WHEN THE PUMPS ARE FITTED WITH LEVEL CONTROLS FOR AUTOMATIC STARTING AND STOPPING.

IT IS RECOMMENDED THAT IRRESPECTIVE OF TYPE OF PUMP, ADEQUATE MOTOR PROTECTION SWITCHGEAR SHOULD BE USED AT THE INSTALLATION. WE STRONGLY RECOMMEND THE USE OF SUITABLE CONTROL BOXES WHICH ARE AVAILABLE FROM US INCORPORATING ALL REQUIRED PROTECTION.

IT IS IN THE INTEREST OF THE USER THAT HE GO THROUGH THIS MANUAL IN DETAIL PRIOR TO USING THE PUMP. THE MANUAL WILL HELP HIM UNDERSTAND THE CONSTRUCTIONAL FEATURES AND TO OBTAIN TROUBLE FREE SERVICE FROM THE PUMP.

PURPOSE:

THE PUMP HAS BASICALLY BEEN DESIGNED AS A DEWATERING UNIT TO PUMP OUT FLOODED INSTALLATIONS OR ANY CONDITIONS THAT NEED DEWATERING OF UNWANTED FLUIDS. THE PUMP HAS BEEN DESIGNED TO HANDLE WATER CONTAMINATED WITH OIL AS WELL AS ABRASIVE PARTICLES NORMALLY ASSOCIATED WITH RAW WATER. THE MAXIMUM SIZE OF PARTICLES THAT CAN BE HANDLED IS APPROX. 0.5"



OVERALL DIMENSIONS AND WEIGHT.

OVERALL HEIGHT 60.5"/1538 MM (APPROX.)
MAX. DIAMETER 30.5"/776 MM (APPROX.)
MAX. WEIGHT (EXCL. CABLE) 1540 lbs.

MAINTENANCE SERVICES REQUIRED.

THE FOLLOWING CHECKS TO BE DONE AT INTERVALS INDICATED BELOW:

1. CONDITION OF SEALS TO BE CHECKED AT EVERY 2500 HOURS OF OPERATION BY ASCERTAINING THE CONDITION OF OIL IN THE SEAL CHAMBER.
2. MONTHLY RUNNING OF PUMP FOR AT LEAST 5/10 MINUTES AND CHECKING OF AMPERES DRAWN AND INSULATION RESISTANCE. (MIN. INSULATION RES. 1 MEG. OHM. AND MAX. CURRENT DRAWN AS PER NAME PLATE)

SAFETY PRECAUTIONS.

1. ENSURE THAT THE INSULATION RESISTANCE OF THE MOTOR IS AT LEAST 1 MEG. OHM BEFORE ENERGIZING THE UNIT.
2. CHECK THAT THE AVAILABLE POWER SUPPLY (VOLTAGE, PHASE, FREQUENCY) MATCHES WITH THE DETAILS ON THE PUMP NAMEPLATE.
3. ENSURE THAT THE GROUND WIRE IN THE 4 CORE CABLE SUPPLIED WITH THE PUMP IS SECURELY EARTHED.
4. ENSURE DISCHARGE CONNECTION IS CORRECTLY AND SECURELY FITTED
5. ENSURE DELIVERY HOSE IS FREE FROM KINKS AND SHARP BENDS.
6. **DO NOT LIFT OR PULL THE PUMP UNDER ANY CIRCUMSTANCES BY MEANS OF THE CABLE.** THE PUMP MUST BE LOWERED/LIFTED FROM THE AREA TO BE PUMPED BY USING A LIFTING ROPE ATTACHED TO THE EYEBOLTS PROVIDED ON THE TOP OF THE PUMP.
7. WHEN THE PUMP IS ENERGIZED IT WILL KICK WHICH IS OPPOSITE TO THE DIRECTION OF ROTATION OF THE IMPELLER. ENSURE THE KICK IS IN THE CORRECT DIRECTION (SEE THE ARROW MARKED ON THE PUMP). SHIFT ANY TWO PHASES IN POWER SUPPLY IF THE KICK IS WRONG.
8. DRY RUNNING OF THE PUMP IS NOT DESIRABLE. HOWEVER THE PUMP WILL NOT BE DAMAGED OR SUFFER ANY ILL EFFECTS IF IT IS RUN DRY FOR SHORT PERIODS (UPTO APPROX. 10 MINUTES).
9. **THE MAXIMUM PUMP SUBMERGENCE RECOMMENDED IS 50 FEET.**
10. ENSURE CORRECT RATING H.R.C. BACK UP PROTECTION FUSES ARE INSTALLED IN POWER CIRCUIT BEFORE STARTING THE PUMP. (REFER TABLE BELOW).
11. **THE MAXIMUM SPECIFIC GRAVITY OF PUMPED FLUID SHOULD NOT EXCEED 1.1. PUMP IS DESIGNED TO OPERATE IN FLUIDS WITH pH from 6 - 11.**
12. **IF PUMP IS NOT USED AND LYING IN STORAGE FOR MORE THAN 30 DAYS PLEASE ENSURE THAT THE SEAL FACES ARE NOT GAUGE LOCKED - ROTATE THE IMPELLER/KICK START THE UNIT ONCE A MONTH. REFER TO INSTRUCTIONS ON DISASSEMBLY/REASSEMBLY OF MECH. SEALS IN THE EVENT THE FACES HAVE LOCKED.**
13. 110HP @60HZ/460, 128FLA; 82kW @ 50HZ/400V, 147FLA



MAINS VOLTAGE AT SITE

HRC FUSE RECOMMENDED

380 VOLTS / 3 PHASE
460 VOLTS / 3 PHASE

250 AMPERES
200 AMPERES

FAULT FINDING IN THE UNIT.

TROUBLE GUIDE	CAUSE	REMEDY
<u>PUMP DOES NOT START.</u>	1.FUSES BLOWN. 2.CABLE DAMAGED 3.NO POWER. 4.BLOCKED IMPELLER. 5.STATOR WINDING BURNT.	1.REPLACE FUSES 2.SHORTEN/REPLACE CABLE 3.CHECK POWER SUPPLY. 4.CLEAN BOTTOM PARTS. 6.REPLACE STATOR/REWIND
<u>PUMP STARTS BUT STOPS.</u>	1.BLOCKED IMPELLER. 2.IMPELLER ROT.WRONG 3.CONNECTED FOR WRONG VOLTAGE. 4.VOLTAGE LOW/HIGH 5.CLOGGED STRAINER 6.PUMP RUNNING DRY 7.WATER TOO WARM (ABOVE 60 DEGREES C)	1.CLEAN BOTTOM PARTS. 2.SHIFT TWO PHASE CONN. 3.CHECK & RECONNECT. 4.CONTACT POWER CO. 5.CLEAN STRAINER 6.SWITCH OFF POWER 7.SWITCH OFF POWER
<u>PUMP GIVES TOO LITTLE OUTPUT</u>	1.IMPELLER ROT.BACKWARD. 2.PUMP WORN DOWN. 3.LONG HOSE AND DIAMETER TOO SMALL. 4.PRESSURE HEAD TOO HIGH 5.DISCHARGE HOSE TORN 6.LEAKING/CRACKED OUTLET	1.SHIFT TWO PHASE CONN. 2.REPLACE WEAR PARTS 3.CHECK PRESSURE LOSSES 4.USE PUMPS IN TANDEM. 5.USE NEW HOSE 6.REPL.OUTLET/GASKET.

OPTIONAL FEATURES INCLUDE START/DELTA START, SEAL PROBE SENSOR OR THERMAL OVERLOAD PROTECTION. EXTERNAL CONTROL BOXES ARE AVAILABLE FOR THE ABOVE FEATURES. PLEASE CONTACT MODY.

Illinois Location:
(847) 841-7867
860 Church Rd Elgin, IL 60120

Minnesota Location:
(651) 758-7867
330 Mill Bay South Suite :
Afton, MN 55001

PumpSupplyInc.com





PUMP SUPPLY
INCORPORATED

TECHNICAL DESCRIPTION.

THE MODY SUBMERSIBLE PUMP IS IN ITSELF A COMPLETE PUMPING STATION. BESIDES A POWER SUPPLY, CONTROL BOX AND A DISCHARGE HOSE NO EXTRA EQUIPMENT IS REQUIRED. THE COMPLETE PUMPSET IS IN A MODULAR CONSTRUCTION ENSURING GOOD AND SIMPLE SERVICEABILITY. MAJOR DESIGN FEATURES ARE AS UNDER:

THE MOTOR

A RUGGED ALUMINUM DIE CAST ROTOR DYNAMICALLY BALANCED TO GRADE 2.5 ACCURACY OF ISO 942. A STAINLESS STEEL SHAFT RUNNING IN TWO BALL BEARINGS. INSULATION CLASS "H" (180 DEGREES CELSIUS). END WINDINGS DULY EPOXY COATED TO PREVENT DETERIORATION OF INSULATION EVEN IN EXTREMELY HUMID CONDITIONS. WINDING WIRE IS DUAL COATED SUITABLE FOR "H" CLASS INSULATION.

THE SEAL CHAMBER

THE HEART OF THE MODY PUMP. TANDEM MECHANICAL, TUNGSTEN CARBIDE V/S TUNGSTEN CARBIDE SEAL FACES (LOWER SEAL) AND TUNGSTEN CARBIDE V/S TUNGSTEN CARBIDE (UPPER SEAL), SECONDARY SEALS OF HNBR RUBBER AND METAL PARTS IN STAINLESS STEEL, RUNNING IN AN OIL BATH - CREATES THE ULTIMATE SEAL SOLUTION. THE DESIGN OPTIMIZES SEAL LIFE AND ALLOWS FOR SIX MONTHLY (2500 HOURS) SERVICE INTERVALS.

BEARINGS.

TWO ANGULAR CONTACT BALL BEARINGS (IMPELLER SIDE), ARRANGED BACK TO BACK, FILLED WITH A SPECIAL HIGH TEMPERATURE BEARING GREASE REQUIRING NO PERIODIC MAINTENANCE WHATSOEVER. THE TOP BEARING IS A SINGLE ROW DEEP GROOVE BALL BEARING, GREASE FILLED AND SEALED FOR LIFE.

THE HYDRAULIC ELEMENTS.

THE HARDENED STAINLESS STEEL IMPELLER RUNNING AGAINST A RUBBER LINED DIFFUSER AND WEAR PLATE, CONSTITUTE THE HYDRAULIC ELEMENTS OF THE PUMP. THE IMPELLER/DIFFUSER CAN BE ADJUSTED TO MAINTAIN MAXIMUM OUTPUT AFTER USAGE WITHOUT PARTS REPLACEMENT. IT IS IMPORTANT, HOWEVER, TO MAINTAIN CLEARANCES BETWEEN THE WEAR PARTS.

CABLE GLAND ASSEMBLY. (REFER DRG.)

THE PUMP IS SUPPLIED WITH 50 FEET CABLE AS STANDARD. THE CABLE IS A 4 CORE EPR SHEATHED AND INSULATED CABLE CONFORMING TO INT'L STD. THE CABLE IS WATERPROOF AND CAN BE COMPLETELY SUBMERGED IN WATER. THE CABLE IS TERMINATED IN THE PUMP AT THE CABLE GLAND. THE GLAND ASSEMBLY SEALS THE CABLE ON THE OUTSIDE SHEATH AS WELL AS A WATER DAM ARRANGEMENT IS PROVIDED WHICH SEALS THE INDIVIDUAL CORES OF THE CABLE. THIS FEATURE IS UNIQUE AND IS ESSENTIAL TO PREVENT WATER SEEPING THROUGH THE CORES OF THE CABLE INTO THE MOTOR CHAMBER IN THE EVENT OF A CUT CABLE. THE CABLE IS ALSO SHEATHED FOR THE FIRST ONE METER BY MEANS OF A CABLE GRIP MADE OF STAINLESS STEEL. THIS IS ESSENTIAL TO ENSURE THAT THERE IS NO UNDUE STRAIN ON THE CABLE IF THE PUMP IS PULLED OR LOWERED INADVERTENTLY BY MEANS OF THE CABLE. COMPLETE DETAILS OF THE CABLE GLAND ASSEMBLY ARE SHOWN IN THE DRAWING.



NON REPAIRABLE ITEMS

1. ALL "O" RINGS TO BE REPLACED WHENEVER PARTS ARE DISMANTLED.
2. SEAL ELASTOMER PARTS SHOULD NEVER BE RE-USED AFTER DIS-ASSEMBLY.
3. DO NOT REFILL BEARING GREASE. NEW BEARINGS MUST BE INSTALLED WITH SPECIAL HIGH TEMPERATURE GREASE.

ELECTRICAL INFORMATION.

MOTORS ARE DESIGNED TO OPERATE ON SINGLE VOLTAGE AND FREQUENCY. MAXIMUM DEVIATION IN VOLTAGE ALLOWED IS +/-6% AND FREQUENCY +/-3%. CHECK NAME PLATE FOR OPERATING VOLTAGE AND FREQUENCY.

DISMANTLING AND OVERHAULING.

GENERAL OVERHAUL AND OIL CHECK

1. ALWAYS REPLACE O-RINGS WITH NEW ONES WHENEVER DISMANTLING AND RE-ASSEMBLING A PUMP. NEVER RE-USE OLD O-RINGS.
2. ALWAYS ISOLATE THE UNIT BEFORE REMOVING THE CABLE GLAND (63). BE CAREFUL WITH O-RINGS (27, 28, and 64) AND SEALING SURFACES. PROTECT THE CHAMBER AGAINST RAIN AND MOISTURE.
3. DISCONNECT STATOR LEADS. SNIP OFF LEAD WIRE CONNECTORS AND UNSCREW EARTHING SCREW. LOOSEN SCREWS, REMOVE CABLE GROMMET (58) AND CABLE LEAD GROMMET (57). CLEAN THE SEALING SURFACES CAREFULLY AND GREASE THE NEW O-RINGS BEFORE FITTING THE SAME. DO NOT USE THE OLD O-RINGS.
4. LOOSEN HEX. BOLTS AND LOCK WASHERS (34) AND REMOVE BASE PLATE, STRAINER (18), DIFFUSER CENTER (45). PRY OUT DIFFUSER RING (17) FROM OUTER CASING (15). THE DRAWING SHOWS THESE DETAILS. CHECK BY HAND THAT THE ROTOR SHAFT IS NOT JAMMED.
5. PLACE THE PUMP ON THE BOTTOM STUDS (29). TAP THE OUTER CASING (15) WITH NYLON HAMMERS/MALLET TILL IT LOOSENS FROM THE TOP BRACKET (2). SEPARATE THE OUTER CASING FROM THE TOP BRACKET BY EMPLOYING TWO SCREW DRIVERS AS LEVERS AND PUSH THE OUTER CASING DOWNWARDS TILL IT STANDS ON THE FLOOR. LIFT THE UNIT BY THE LIFTING HOOKS (19) CLEAR OFF THE OUTER CASING.
6. THE SEAL CHAMBER CONTAINS APPROX. 6.5 LITERS OF OIL. THE LEVEL AND CONDITION OF THE OIL SHOULD BE CHECKED EVERY SIX MONTHS. UNSCREW THE OIL PLUGS AND POUR OUT SOME OIL. NOTE THAT THE OIL GETS A SLIGHTLY DARKER SHADE, BUT THIS IS NORMAL AND IS NO CAUSE FOR WORRY. IF THE OIL IS EMULSIFIED BY WATER, THE SEALS HAVE WORN OUT AND MUST BE REMOVED FROM THE ROTOR FOR FURTHER ACTION.
7. LAY DOWN THE PUMP AND REMOVE THE REMAINING PARTS. UNSCREW NUT AND REMOVE LOCK WASHER (31) (USE IMPELLER SPANNER (T7009) TO HOLD IMPELLER WHILE UNSCREWING NUTS) AND SLIDE OFF IMPELLER (16) FROM SHAFT. THEN REMOVE TRIMMING SPACERS AND SAND GUARD (44). THE SAND GUARD IS SCREWED TO THE SEAL HOUSING (13) WITH FOUR CHEESE HEAD SCREWS.
8. UNSCREW SCREWS (54) AND REMOVE WEAR PLATE (14). THIS CAN BE EASILY DONE BY INSERTING TWO SCREWDRIVERS BETWEEN WEAR PLATE AND LOWER BRACKET (9) AND PRYING THE WEAR PLATE LOOSE. ALL THE PUMP PARTS HAVE BEEN DISMANTLED. REPLACE WORN PARTS.



9. UNSCREW BOTH THE OIL PLUGS AND DRAIN OUT THE OIL FROM THE OIL CHAMBER. REMOVE OUTER CIRCLIP (12) FROM ROTOR SHAFT AND REMOVE LOWER MECHANICAL SEAL. BE VERY CAREFUL IN HANDLING THE TUNGSTEN CARBIDE SEAL FACE. LEAVE STATIONARY TUNGSTEN CARBIDE SEAT IN THE SEAL HOUSING. PULL OUT SEAL HOUSING (13). THE STATIONARY TUNGSTEN CARBIDE SEAL FACE WILL COME OUT WITH THE SEAL HOUSING. HANDLE THE FACE CAREFULLY. THE UPPER MECHANICAL SEAL IS NOW IN VIEW. REMOVE THE UPPER SEAL IN THE SAME WAY AS THE LOWER SEAL

10. THE LOWER BRACKET COMPLETE WITH THE ROTOR (1), BEARING (10), BEARING COVER (11) AND TUNGSTEN CARBIDE SEAT WILL COME OUT WITH THE LOWER BEARING BRACKET. REMOVE BOLTS (42) AND REMOVE BEARING COVER. PULL OUT ROTOR WITH BEARING FROM LOWER BEARING BRACKET. (IF THIS IS DIFFICULT USE A HAND PRESS TO REMOVE ROTOR FROM BEARING BRACKET. ENSURE NO DAMAGE TO THE TUNGSTEN CARBIDE SEAT IN BEARING BRACKET). THE TC SEAT WITH CUP SEAL HOLDER CAN NOW BE PUSHED OUT FROM THE BEARING SIDE BY GENTLY TAPPING THE SAME. (USE FINGERS OR A NYLON TIPPED LIGHT HAMMER ONLY).

11. CHECK BOTH UPPER AND LOWER BEARINGS (3 & 10) FOR ANY RADIAL OR AXIAL PLAY OR ANY ABNORMAL NOISE WHILE SPINNING THE SAME. CHECK FOR ANY LEAKAGE OF GREASE THROUGH THE SHIELD OF THE UPPER BEARING. IF BEARING SEEMS WORN OUT OR ANY GREASE LEAKAGE IS OBSERVED, REPLACE BEARING. (DO NOT USE ANY STANDARD BEARING PROCURED FROM THE MARKET. THE PUMPS USE BEARINGS WHICH ARE PRE-FILLED WITH A SPECIAL HIGH TEMPERATURE GREASE AVAILABLE FROM US READILY).

12. THE TOP BRACKET (2) IS HELD IN POSITION BY EIGHT STUDS (35) ON THE INNER CASING. UNSCREW THE NUTS AND REMOVE THE INNER CASING WITH THE HELP OF PULLER FOR STATOR (T8006). ALTERNATIVELY TWO SCREWDRIVERS MAY BE USED TO PRY THE TOP BRACKET FROM THE STATOR.

13. THE STATOR IS SHRINK-FITTED IN THE INNER CASING. THE STATOR CAN NOW BE CHECKED FOR ANY ELECTRICAL FAULTS.

14. IF THE STATOR MEGS LOW BAKE IT IN AN OVEN FOR 3 HOURS AT 300F. MEG OHM TEST THE STATOR AND ALSO MEASURE LINE TO LINE RESISTANCE. THE RESISTANCE VALUE SHOULD BE APPROXIMATELY THE SAME BETWEEN THE THREE LEGS/PHASES OF THE WINDING. PERFORM A HI-POT TEST IF POSSIBLE.

Illinois Location:
(847) 841-7867
860 Church Rd Elgin, IL 60120

Minnesota Location:
(651) 758-7867
330 Mill Bay South Suite 100
Afton, MN 55001

PumpSupplyInc.com

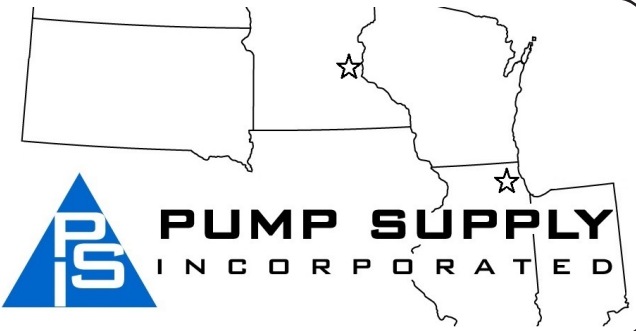

The complex block contains contact information for two locations and a logo. On the left, the Illinois location is listed with phone number (847) 841-7867 and address 860 Church Rd Elgin, IL 60120. Below it, the Minnesota location is listed with phone number (651) 758-7867 and address 330 Mill Bay South Suite 100, Afton, MN 55001. At the bottom left of the block is the website PumpSupplyInc.com. On the right side of the block is a map showing the outlines of Illinois and Minnesota. A star is placed in the western part of Illinois, and another star is placed in the southern part of Minnesota. Below the map is the Pump Supply Incorporated logo, which consists of a blue triangle containing the letters 'PS' in white, followed by the words 'PUMP SUPPLY' in a large, bold, sans-serif font, and 'INCORPORATED' in a smaller, spaced-out, sans-serif font below it.

RE-ASSEMBLY OF THE PUMPSET.

THE PUMP CAN BE RE-ASSEMBLED AS PER PROCEDURE GIVEN BELOW. PLEASE HOWEVER NOTE THE FOLLOWING:

- A) ALWAYS REPLACE NEW O-RINGS AND DISCARD OLD ONES.
- B) REPLACE LOCK WASHER WHEN RE-ASSEMBLING.

1. THE CHECKED/REPAIRED STATOR IS KEPT UPRIGHT AND THE TOP BRACKET IS AFFIXED THROUGH THE EIGHT STUDS (35).
2. ALL THE ELECTRICAL CONNECTIONS OF THE STATOR LEAD WIRES AND EARTHING WIRE SHOULD BE SECURE AND INSULATED.
3. SLIDE BEARING COVER (11) ON ROTOR SHAFT.
4. FIT BEARINGS (IF REMOVED OR REPLACED) ON ROTOR SHAFT (USE EITHER A HAND PRESS OR SHRINK THE SAME -- DO NOT HAMMER THE BEARINGS ON THE SHAFT-- YOU MAY SCORE/BEND THE SHAFT AND ALSO DAMAGE THE BEARINGS) AND FIT CIRCLIPS ON TOP AND BOTTOM GROOVES ON SHAFT. (IF THE BEARINGS ARE SHRINK FITTED ON THE SHAFT, HEAT THE BEARINGS IN OIL TO A MAXIMUM TEMPERATURE OF 120 DEGREES CELSIUS AS A HIGHER TEMPERATURE WILL LIQUEFY THE GREASE IN THE BEARING AND RENDER THE SAME UNUSABLE). DO NOT REUSE OLD BEARINGS THAT HAVE BEEN PULLED OFF.
5. SLIDE LOWER BEARING BRACKET (10) ON TO LOWER BEARING AND ALIGN HOLES ON BEARING COVER WITH THE TAPPED HOLES ON LOWER BEARING BRACKET. FIT THE BOLTS AND TIGHTEN BEARING COVER.
6. FIT COMPLETE ROTOR ASSEMBLY IN STATOR HOUSING GUIDING UPPER BEARING IN TOP BEARING BRACKET SEAT. TIGHTEN BOLTS. FIT UPPER TC SEAT IN LOWER BEARING BRACKET (LIGHTLY OIL THE RUBBER SEAT CUP -- ENSURE THE SEAT SITS SQUARE IN THE BRACKET) AND SLIDE ON UPPER SEAL ASSEMBLY ON ROTOR SHAFT. (USE SEAL ASSEMBLY MANDREL (T9004) TO ASSIST IN SLIDING BELLOWS ON TO THE SHAFT). LIGHTLY OIL THE ROTOR SHAFT BEFORE PUSHING BELLOWS ON SHAFT. USE EXTREME CARE SO THAT THE SEAL FACES ARE NOT DAMAGED. SLIDE ON CIRCLIP (12) AND FIT IN GROOVE ON SHAFT.
7. PRESS BY HAND LOWER SEAL TUNGSTEN CARBIDE SEAT INTO SEAL HOUSING (13). LIGHTLY OIL THE RUBBER SEAT CUP BEFORE PRESSING IN CAVITY. THE SEAT MUST SIT SQUARE IN THE HOUSING.
8. FIT SEAL HOUSING (13) INTO LOWER BRACKET AND TIGHTEN BOLTS.
9. SLIDE ON LOWER SEAL ASSEMBLY ON SHAFT. APPLY LIGHT COAT OF OIL ON SHAFT BEFORE SLIDING BELLOWS ON THE SAME. (USE SAME SEAL MANDREL AS USED FOR THE UPPER SEAL TO SLIDE BELLOWS ON SHAFT). FIT CIRCLIP (4) AS FOR THE UPPER SEAL ASSEMBLY.
10. INSTALL SAND GUARD (44) INTO SEAL HOUSING USING THE FOUR CHEESE HEAD SCREWS.
11. FIT ONE DRAIN PLUG WITH "O" RING IN LOWER BEARING BRACKET AND FILL OIL IN THE OIL CHAMBER KEEPING THE THIRD OIL PLUG OPEN ENSURING NO AIR IS ENTRAPPED INSIDE. REPLACE PLUGS WITH "O" RINGS.
12. SLIDE ON WEAR PLATE AGAINST LOWER BEARING BRACKET AND TIGHTEN THE SAME. FIT KEY (30) ON THE SHAFT AND SLIDE ON IMPELLER. CLEARANCES BETWEEN IMPELLER AND WEAR PLATE CAN BE ADJUSTED BY MEANS OF THE TRIMMING SPACERS. SLIDE ON LOCK WASHER (31) ENSURING THAT TONGUE OF LOCK WASHER IS IN GROOVE OF THREADING AND TIGHTEN NUT. BEND LOCK WASHER OVER ANY SIDE OF THE HEX NUT. ENSURE THAT ROTOR SHAFT IS ROTATING FREE.



14. FIT OUTER CASING ON TOP BRACKET WITH "O" RING. FIT DIFFUSER RING AND DIFFUSER HOLDER AND TIGHTEN NUTS. FIT DIFFUSER CENTER AND ADJUST CLEARANCE BETWEEN IMPELLER AND DIFFUSER CENTER TO THE MINIMUM BY USING TRIMMING WASHERS. FIX STRAINER, BASE PLATE AND TIGHTEN BOLTS

OIL SPECIFICATIONS

- A). SHELL TELLUS 29.
- B). EXXON UNIVOLT 61
- C) CHEVRON SUPERLA FDA APPROVED # 10

USE NON-CONDUCTING, NON-FOAMING, NON-DETERGENT OIL ONLY

PARTS CATALOG

1. COMPONENTS LIST :

DRAWINGS :

- 1. SECTIONAL ASSEMBLY
- 2. MATERIAL PARTS LIST

R: RECOMMENDED SPARES FOR TWO YEARS OPERATION

<u>SR. NO.</u>	<u>DESCRIPTION</u>	<u>PART NO.</u>	<u>RECOMMENDED QTY.</u>
1.	MECHANICAL SEAL	535-050-00	2 NOS.
2.	"O" RING SET	"O" Ring Set	2 SETS.
3.	CABLE GROMMET	260-121-66	2 NOS.
4.	CABLE LEAD GROMMET	260-122-66	2 NOS.
5.	UPPER BEARING	020-025-07	1 NOS.
6.	LOWER BEARING	020-026-07	1 SET.
7.	IMPELLER (60HZ)	300-142-22	1 NOS.
8.	DIFFUSER CENTER	155-015-80	1 NOS.
9.	WEAR PLATE LOCK	715-017-80	1 NOS.
10.	WASHER	695-013-21	2 NOS.

REFER TO PARTS LIST AT END OF MANUAL FOR CORRECT CABLE GROMMETS.

Illinois Location:

(847) 841-7867
860 Church Rd Elgin, IL 61

Minnesota Location:

(651) 758-7867
330 Mill Bay South Suite:
Afton, MN 55001

PumpSupplyInc.com

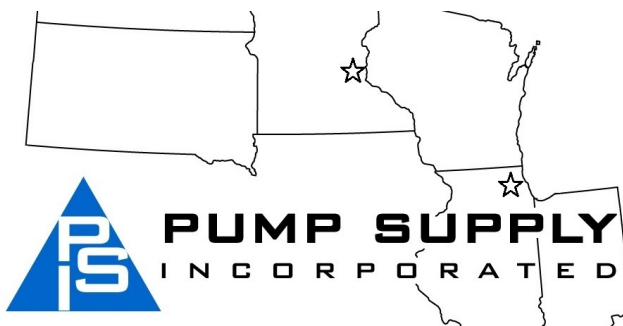



G1304T

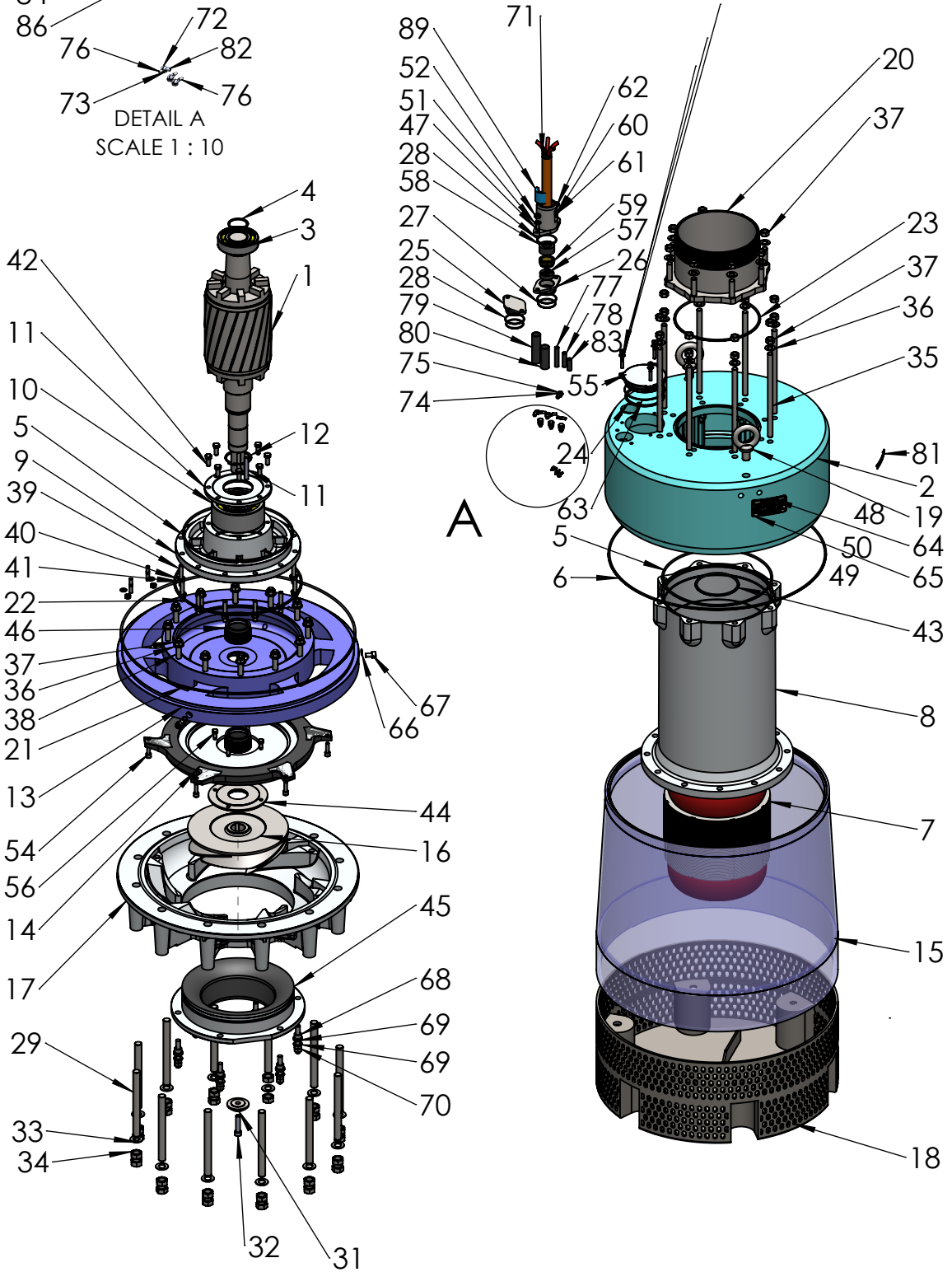
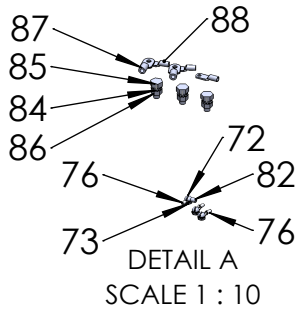

PUMP SUPPLY
INCORPORATED

G1304T PART LIST

ITEM NO.	PART NUMBER	DESCRIPTION	QTY.
1	480-080-00	ROTOR COMPLETE	1
2	035-082-30	TOP BRACKET	1
3	020-025-07	BEARING	1
4	080-020-08	CIRCLIP	1
5	380-204-66	O'RING	2
6	380-206-66	O'RING	1
7	619-115-00	BARE STATOR	1
8	625-051-30	STATOR CASING	1
9	035-081-30	LOWER BEARING BRACKET	1
10	020-026-07	BEARING	1
11	037-013-01	BEARING COVER	1
12	080-021-08	CIRCLIP	1
13	545-020-30	SEAL HOUSING	1
14	715-017-80	WEAR PLATE	1
15	400-050-04	OUTER CASING	1
16	300-132-22	IMPELLER 60Hz	1
17	170-008-80	DIFFUSER RING	1
18	030-032-04	PUMP BASE /STRAINER	1
19	270-023-21	LIFTING HOOK	2
20	405-138-21	OUTLET	1
21	380-207-66	`O' RING	1
22	380-205-66	`O' RING	1
23	380-039-66	`O' RING	1
24	380-202-66	`O' RING	1
25	430-054-21	BLANK CAP	1
26	235-028-21	CABLE GLAND BASE	1
27	380-013-66	`O' RING	2
28	380-201-66	O'RING	3
29	650-105-21	STUD	12
30	320-042-21	KEY	1
31	695-013-21	LOCK WASHER	1
32	520-015-21	CAP SCREW	1
33	700-015-21	WASHER	12
34	370-020-21	HEX. HD. NUT	24
35	650-102-21	STUD	8
36	700-010-21	WASHER	28
37	370-015-21	HEX. HD. NUT	36
38	650-056-21	STUD	20

39	650-059-21	STUD	12
40	700-008-21	WASHER	12
41	370-009-21	HEX. HD. NUT	12
42	045-033-21	BOLT	8
43	380-203-66	`O' RING	1
44	515-014-21	SAND GUARD	1
45	155-015-80	DIFFUSER CENTERE	1
46	535-050-00	MECHANICAL SEAL	2
47	650-020-21	STUD	4
48	650-011-21	STUD	3
49	700-004-21	WASHER	3
50	370-006-21	NUT	3
51	700-006-21	WASHER	4
52	370-008-21	NUT	4
53	650-106-21	STUD	6
54	520-004-21	CAP SCREW	6
55	105-016-30	TERMINAL COVER	1
56	045-016-21	HEX. HD. BOLT	4
57	260-122-66	LEAD GROMMET FOR CABLE	1
58	260-121-66	CABLE GROMMET FOR CABLE	1
59	600-110-40	SPACER FOR GLAND	1
60	525-020-21	C.H. SCREW	2
61	085-029-21	CABLE CLAMP	1
62	230-018-21	CABLE GLAND	1
63	380-208-66	O' RING	1
64	350-027-21	NAME PLATE	1
65	465-006-21	RIVET	6
66	380-049-66	O'RING	3
67	520-016-21	CAP SCREW	3
68	710-021-21	WASHER	6
69	700-009-21	WASHER	30
70	370-019-21	NUT	12
71	065-042-82	CABLE 4G35 + 2(2 X 1.5)	1
72	370-004-21	M5 x .80 5.0mm Slotted round head screw	3
73	525-001-21	M5 x .80 Nut with star washer	3
74	700-002-21	WASHER	1
75	525-019-21	M6 x 10 Pan head screw	1
76	740-001-46	LUG FOR EARTHING	5

77	278-003-50	Single wall heat shrink 12.72mm I.D x 70mm length	1
78	278-002-50	Single wall heat shrink 12.72mm I.D x 50mm length	1
79	278-007-50	single wall heat Shrink 25.40mm I.D x100mm length	1
80	278-006-50	single wall heat Shrink 25.40mm I.D x 70mm length	1
81	635-009-21	ARROW	1
82	740-006-46	Lug for sensor probe leads	1
83	278-001-50	Double wall heat Shrink 12.72mm I.D x 40mm length	1
84	695-015-46	lock washer for M8 nut	3
85	045-008-21	M8 1.25 pitch 15mm bolt	3
86	370-006-21	M8 x 1.25 pitch nut	3
87	740-010-46	Lug for stator lead	3
88	740-012-46	Lug for Power lead	4
89	662-008-66	cable support	1
90	O' RING SET	O' RING SET (5 6 21 22 23 24 27 28 43 63 66)	1

Illinois Location:
(847) 841-7867
860 Church Rd Elgin, IL 60120

Minnesota Location:
(651) 758-7867
330 Mill Bay South Suite :
Afton, MN 55001

PumpSupplyInc.com





PUMP SUPPLY
INCORPORATED



LIMITED WARRANTY

We warrant to our immediate customer and to the ultimate consumer that products of our manufacture will be free of defects in material and workmanship under normal use and service for the following time periods, when installed and maintained in accordance with our instructions.

PUMPS: One (1) year from date of installation or (18) months from date of shipment, whichever occurs first. As used herein, "the ultimate consumer" is defined as the purchaser who first uses the product after it's initial installation or, in the case for product designed for non-permanent installation, the first owner who uses the product. It is the purchaser's or any sub-vendor's obligation to make known to the ultimate consumer the terms and conditions of this warranty. This warranty gives you specific legal rights, and there may also be other rights which vary from state to state. In the event the product is covered by the Federal Consumer Product Warranties Law (1) the duration of any implied warranties associated with the product by virtue of said law is limited to the same duration as stated herein, (2) this warranty is a LIMITED WARRANTY, and (3) no claims of any nature whatsoever shall be made against us, until the ultimate consumer, his successor, or assigns, notifies us in writing of the defect, and delivers the product and/or defective part(s) freight prepaid to our facility or nearest authorized service station. Some states do not allow limitations on how long an implied warranty lasts, so the above limitation may not apply. **THE SOLE AND EXCLUSIVE REMEDY FOR BREACH OF ANY AND ALL WARRANTIES WITH RESPECT TO ANY PRODUCT SHALL BE TO REPLACE OR REPAIR AT OUR ELECTION, FOB POINT OF MANUFACTURE OR AUTHORIZED REPAIR STATION, SUCH PRODUCTS AND/OR PARTS AS PROVEN DEFECTIVE. THERE SHALL BE NO FURTHER LIABILITY, WHETHER BASED ON WARRANTY, NEGLIGENCE OR OTHERWISE.**

Unless expressly stated otherwise, guarantees in the nature of performance specifications furnished in addition to the foregoing material and workmanship warranties on a product manufactured by *Mody*, if any, are subject to laboratory tests corrected for field performance. Any additional guarantees, in the nature of performance specifications must be in writing and such writing must be signed by our authorized representative. Due to inaccuracies in field testing if a conflict arises between the results of field testing conducted by or for user, and laboratory tests corrected for field performance, the latter shall control. Components or accessories supplied by us but manufactured by others are warranted only to the extent of and by the terms and conditions of the original manufacturer's warranty.

RECOMMENDATIONS FOR SPECIAL APPLICATIONS OR THOSE RESULTING FROM SYSTEMS ANALYSES AND EVALUATIONS WE CONDUCT, WILL BE BASED ON OUR BEST AVAILABLE EXPERIENCE AND PUBLISHED INDUSTRY INFORMATION. SUCH RECOMMENDATIONS DO NOT CONSTITUTE A WARRANTY OF SATISFACTORY PERFORMANCE AND NO SUCH WARRANTY IS GIVEN.

This warranty shall not apply when damage is caused by (a) improper installation, (b) improper voltage, (c) lightning, (d) sand or other abrasive materials, (e) scale or corrosion build-up due to excessive chemical content. Any modification of the equipment will also void the warranty. We will not be responsible for loss, damage or labor cost due to interruption of service caused by defective parts. Neither will we accept charges incurred by others without our prior written approval. This warranty is void if our inspection reveals the product was used in a manner inconsistent with normal industry practice and/or our specific recommendations. The purchaser is responsible for communication of all necessary information regarding the application and use of the product. **UNDER NO CIRCUMSTANCES WILL WE BE RESPONSIBLE FOR ANY OTHER DIRECT OR CONSEQUENTIAL DAMAGES, INCLUDING BUT NOT LIMITED TO LOST PROFITS, LOST INCOME, LABOR CHARGES, DELAYS IN PRODUCTION, IDLE PRODUCTION, WHICH DAMAGES ARE CAUSED BY ANY DEFECTS IN MATERIAL, AND/OR WORKMANSHIP AND/OR DELAYS IN SHIPMENT. THIS WARRANTY IS EXPRESSLY IN LIEU OF ANY OTHER EXPRESS OR IMPLIED WARRANTY, INCLUDING ANY WARRANTY OF MERCHANTABILITY OR FITNESS FOR A PARTICULAR PURPOSE.**

No rights extended under this warranty shall be assigned to any person, whether by operation or otherwise, without our prior written approval.

Mody Pumps Inc.: 2166 Zeus Court, Bakersfield, CA 93308 Tel.: (661) 392-7600 Fax: (661) 392-7601