Model DWU, DWXU

Dominator™

Submersible Sewage Pump



Operating Instructions, Installation & Maintenance Manual



EBARA Pumps Americas Corporation



Thank you for purchasing this Ebara Stainless Steel Pump. We hope you are pleased with your purchase and that our pumps will provide you with long service life and exceptional performance.

To ensure satisfactory service life, there are several considerations regarding proper installation, operation and power source. Please review the recommendations outlined within the installation and operation manual.

Please contact your supplier (supplying dealer or contractor) if service is necessary or if you have any questions or need further assistance.

Please retain the following information for your records and to help expedite service:

Purchase Date: _____

Purchased From: _____

Serial No: _____

(Located on the pump nameplate)

Note: For assistance locating the serial number and name plate, please refer to page 4 of your owner's manual.



DWU, DWXU

Contents

Section	Page
Manufacturer Data	3
Pump Identification Data	4
Safety Information/Warnings	5
Electrical Information (Single phase)	6
Wiring Diagrams (Single phase)	8
Electrical Information (Three phase)	10
Wiring Diagrams (Three phase)	11
Typical Wiring Diagram	12
Installation Instructions	13
Installation Diagrams	14
Float Switch Adjustment	15
Troubleshooting	16
Sectional Diagram	17
Assembly and Disassembly	18
Warranty	19



Note: All Models are CSA listed except 3HP Dominator.

File #: 105970

Manufacturer Data

Manufacturer Data
 EBARA Pumps Americas Corporation
 1651 Cedar Line Drive
 Rock Hill, SC 29730



DWU, DWXU

Pump Identification Data

Pump Data

Description: Submersible Sewage Pump
 Model: DWU, DWXU
 Year of manufacture: see name plate on the pump (see nameplate illustration below)

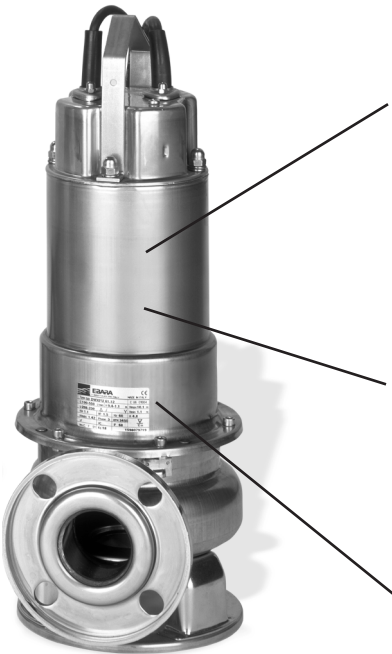

Caution

- Service and installation should be done by a qualified person.
- Provide appropriate motor controls at installation.
- This pump has not been investigated for use in swimming pool areas.

Warning

- Do not connect conduit to the pump.
- Risk of shock, do not remove cord and strain relief.
- To reduce the risk of electric shock, see instruction manual for proper installation.
- To reduce the risk of electric shock connect only to a properly grounded, grounding type receptacle.

 EBARA International Corporation
 1651 Cedar Line Drive, Rock Hill, SC 29730 USA

Model # 50DWXFU6.752
Serial # 1234-1-2
Date 8-17-01

MOTOR TYPE	MEC 90 H 60 M
VOLT	115 Hz 60
2 POLES MOTOR	PHASE 1~
P/N *	S/N *

Note: This label shows all of the electrical data required for proper installation.

⚠ CAUTION
 Call an electrician when in doubt. Improper installation can result in harm to people and/or damage to equipment.



DWU, DWXU

Safety Information and Introduction

WARNING



Before handling this pump, always disconnect the power first.

This pump should only be serviced by a qualified person or a factory trained person.

CAUTION

This instruction manual includes necessary items for installation, operation and maintenance.

Read this manual carefully to ensure correct installation, operation and maintenance.

Be sure to keep this instruction manual on hand for future reference.

EBARA's Dominator sewage pumps are designed for reliable pumping of waste water with suspended solids up to 2" in diameter. **Maximum fluid temperature 40 C, 104 F (possible intermittent duty to 60 C, 140 F when totally submersed).**

Stainless steel construction is ideal for residential, commercial, and industrial applications. Dual seals are a standard feature enhancing the rugged, high service factor motor design.

The EBARA Dominator is superior in dependability and efficiency. High quality components are stronger, dimensionally consistent, and lighter weight compared to conventional cast iron parts. EBARA stainless steel is engineered for the professional and built for lasting performance and value.

Electrical Installation

Electrical service for any sump pump installation must be grounded and separately fused or breakered directly from the entrance box with a single grounding type receptacle. You should never touch a sump pump or discharge piping while the pump is connected to electrical power and water is present. The pump should be disconnected from the electrical source before handling in all cases.

CAUTION

Call an electrician when in doubt. Improper installation can result in harm to people and/or damage to equipment. These models are not recommended for use with VFDs

Discharge Piping Installation

To assure the maximum performance from your pump, the discharge pipe size and piping fittings should not be smaller than the discharge port of the pump. Smaller pipe will add to friction losses and reduce the capacity of the pump.



DWU, DWXU

Safety Information and Introduction (continued)

Normally accepted materials are galvanized pipe, rigid plastic pipe or acceptable flexible pipe or hose. Where the discharge pipe is long, a check valve is often employed to prevent the water from flowing back into the sump when the pump turns off. If the discharge is directed into a sanitary sewer, a suitable anti-siphon device or a free flow check valve should be inserted in the line to prevent back-flow into the pit.

Pump Installation

When the sump, electrical and discharge plumbing installation is complete and ready for the pump, clean all solid debris from the pit. Complete the plumbing connection to the pump and then plug the pump into the electrical outlet. A few extra minutes to test the sump pump installation are now in order.

Fill the sump with water, note the turn on and turn off level of the pump, and the pumping cycle. This will allow you to calculate the approximate discharge flow of the pump system. If everything is operating properly, install the sump cover.

Electrical information – Single Phase

- Pumps are 115 V, 60Hz or 230V 60Hz.
- Please check the voltage rating on the pump nameplate prior to installation.

WARNING



Risk of electric shock

This pump is supplied with a grounding conductor or a grounding-type attachment plug. To reduce the risk of electric shock, be certain that it is connected only to a properly grounded, grounding-type receptacle.

IMPORTANT INSTRUCTIONS BEFORE INSTALLATION

Failure to follow these instructions may cause serious bodily injury and/or property damage.

- Use a separate 15 amp circuit breaker or 15 amp fuse block with the pump.
- **Do not** use an extension cord with the pump.
- **Do not** cut off the ground pin or use an adapter fitting.
- **Do not** work on the pump or switch until any or all power cords are unplugged.
- Failure to follow these guidelines may cause severe damage to the pump and will void warranty.



DWU, DWXU

Electrical information – Single Phase (continued)

1. Before installing or servicing your pump, BE CERTAIN pump power source is disconnected.
2. Installation and electrical wiring must adhere to state and local codes. Check appropriate community agencies, or contact local electrical and pump professionals.
3. **CALL AN ELECTRICIAN WHEN IN DOUBT.** Pump should be connected to a separate 15 amp circuit breaker or 15 amp fuse block. Plugging into existing outlets may cause low voltage at motor, causing blown fuses, tripping of motor overload, or burned out motor.
4. Do not connect pump to a power supply until permanently grounded. For maximum safety, ground pump to a circuit equipped with a ground fault interrupter device.
5. Voltage of power supply must match the voltage of the pump.
6. Before installing pump, clear sump basin of any water, debris, or sediment.

WARNING!

Sump basin must be vented in accordance with local plumbing codes. EBARA DOMINATORS are not designed for and CANNOT be installed in locations classified as hazardous in the National Electric Code, ANSI/NFPA 70.



DWU, DWXU

Wiring Diagram for Automatic Pumps (Single Phase)

- Output 1/2 to 1 HP (0.4kw to 0.75kw)
115V

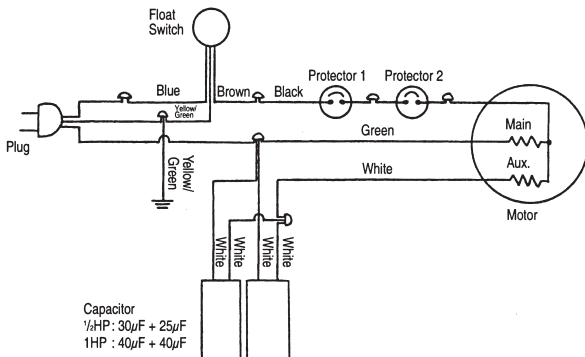

230V

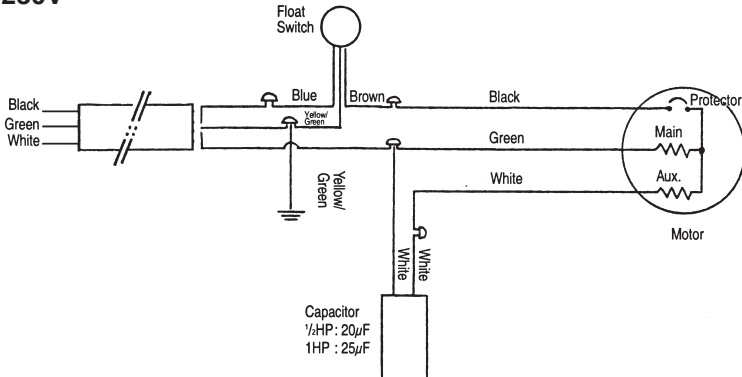

- Output 1 1/2HP (1.1kw)
230V

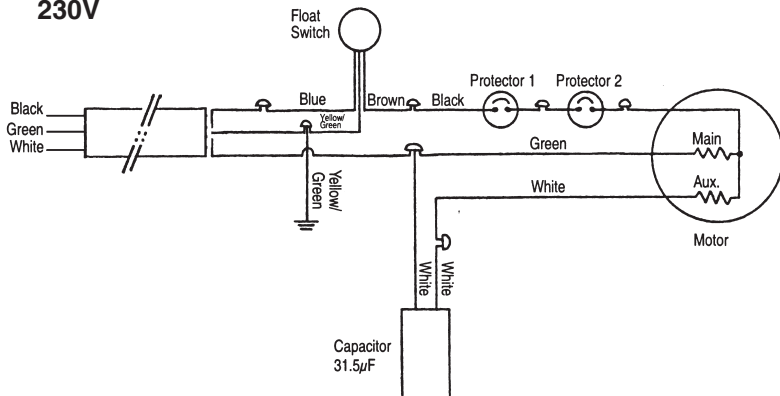

DWU, DWXU

Wiring Diagram for Manual Pumps (Single Phase)

- Output 1/2 to 1 HP (0.4kw to 0.75kw)

115V

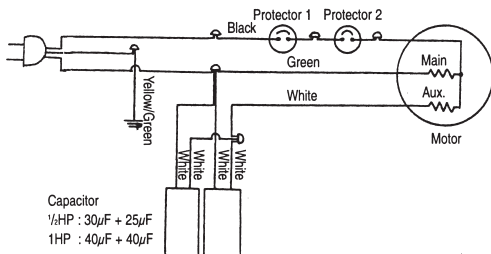

- Output 1/2 to 1 HP (0.4kw to 0.75kw)

230V

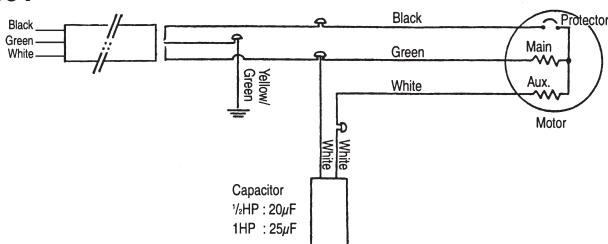

- Output 1 1/2HP (1.1kw)

230V

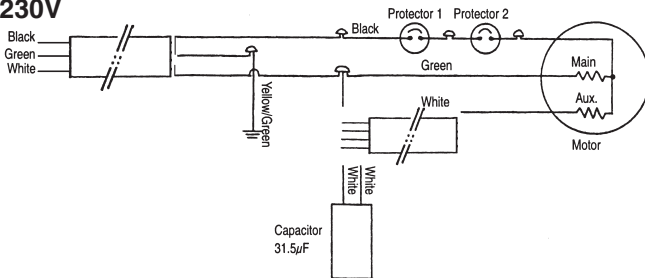

- Output 2HP (1.5kw)

230V

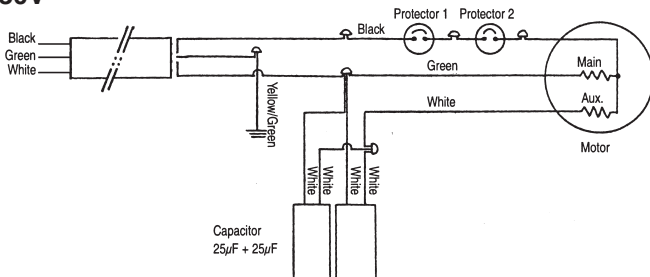

DWU, DWXU

Electrical Information – Three Phase

⚠ WARNING



Check that the power is locked off and disconnected before working on pump. All electric work should be performed by a qualified electrician and all national and local electrical codes must be observed.

(1) Wiring

- a) Wire as indicated in Fig. 4
- b) Loose connections will stop the pump. Make sure all electrical connections are secure.

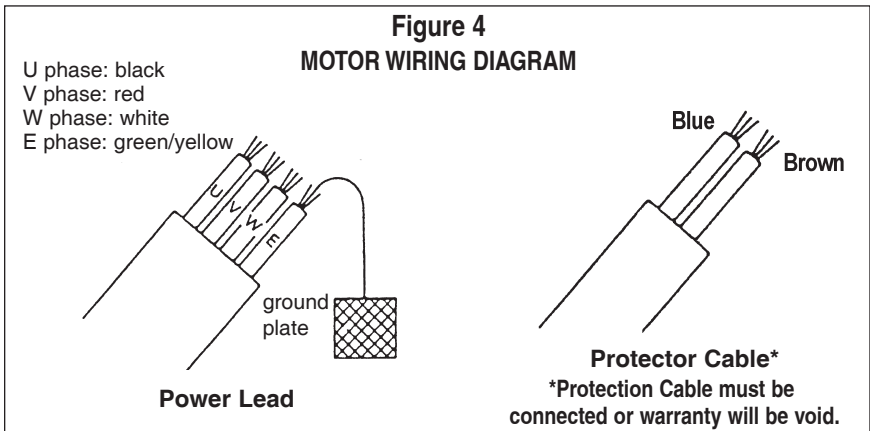

NOTE:

Use with approved motor control that matches motor input in full load amperes.

Utiliser un démarreur approuvé convenant au courant à pleine charge du moteur.

(2) Cable

- a) Never let the end of the cable contact water.
- b) If the cable is extended, do not immerse the splice in water.
- c) Fasten the cable to the discharge piping with tape or vinyl strips.
- d) Install the cable so that it will not overheat. Overheating is caused by coiling the cable and exposing it to direct sunlight.

(3) Grounding

As shown in Fig. 5 ground the green/yellow wire (label E). Under no circumstances should the green/yellow wire be connected to the power supply.

- (4) Use short circuit breakers to prevent danger of electrical shock.



PUMP SUPPLY
INCORPORATED

DWU, DWXU

Wiring Diagram for Manual Pumps (Three Phase)

230V

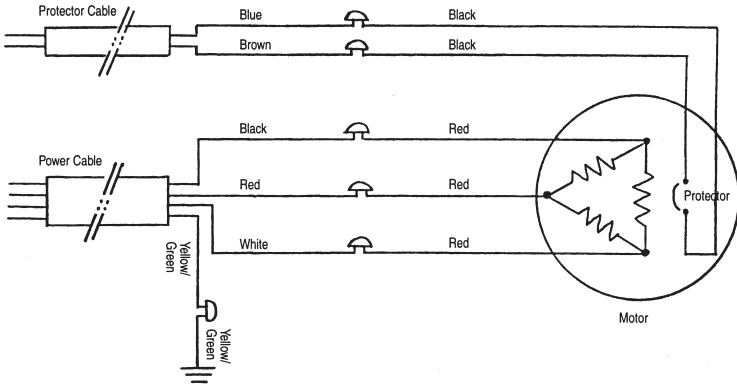

460V

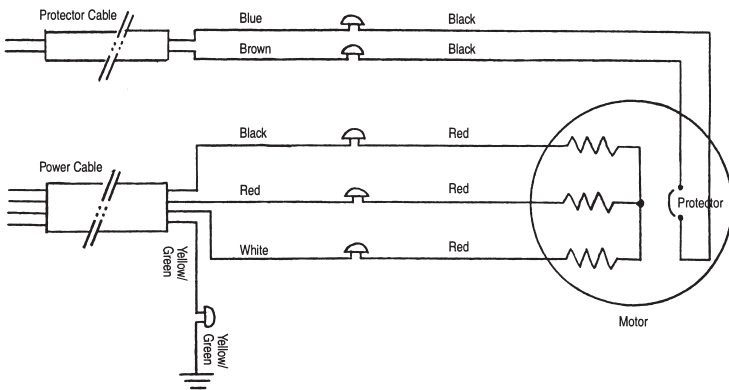

DWU, DWXU

Installation Instructions

Pump Installation

WARNING



When lifting the pump, attach an appropriate lifting cable or rope to the lifting handle before installation.

Do not lift the pump by the electrical cables.

Handle the cables very carefully. Excessive bending or pulling may damage the cable and molded seal, resulting in insulation failure. Protect cable ends against water intrusion.

CAUTION

Check rotation **BEFORE** installation. Correct rotation is clockwise when viewed from top of the motor. Read **ELECTRICAL WIRING**.

1. Clean the installation area.
2. Under no circumstances should the cable be pulled while the pump is being transported or installed. Attach a chain or rope to the grip and install the pump.
3. This pump is **NOT** to be installed on its side. Ensure that it is installed upright and on a secure base.
4. Install the pump at a location in the tank where there is the least turbulence.
5. If there is a flow of liquid inside the tank, support the cable where appropriate.
6. Install piping so that air will not be entrapped. If piping must be installed in such a way that air pockets are unavoidable, install an air release valve wherever such air pockets are most likely to develop.
7. Do not permit end of discharge piping to be submerged as backflow will result when the pump is shut down.
8. Non-automatic pumps do not have an automatic operation system based on built-in floats. Do not operate the pump for an extended period of time with the water level near the minimum operation level as the automatic cut-off switch is incorporated inside the motor will be activated.



DWU, DWXU

Typical Installation with Quick Disconnect

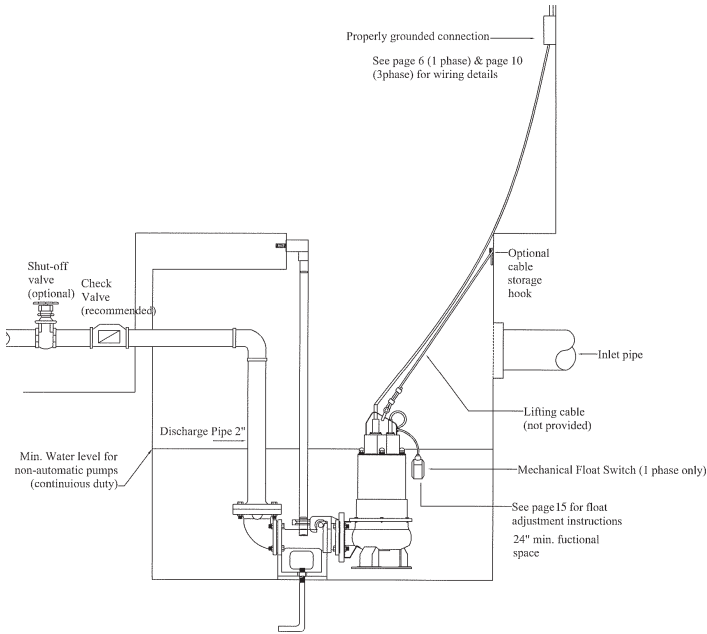

Typical Installation with Pipe

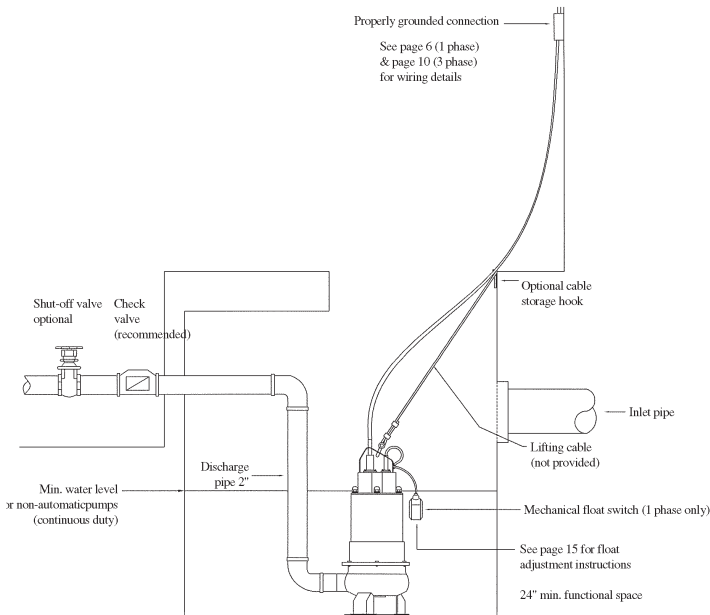

PUMP SUPPLY
INCORPORATED

DWU, DWXU

Float Switch Adjustment

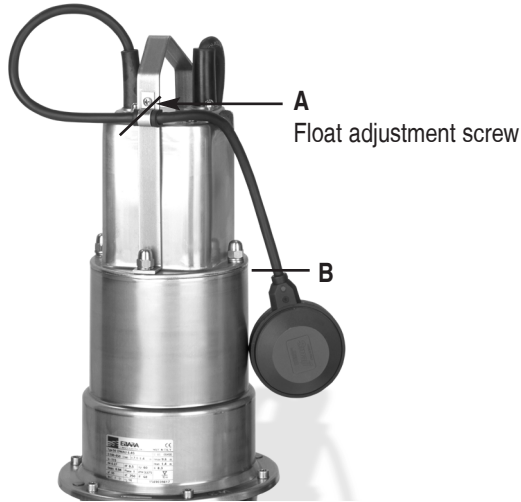

Float Switch Adjustment

Float switch should be adjusted to ensure unrestricted operation.

- Loosen float adjustment screw.
- Adjust float length by sliding float cord through bracket.
- **Minimum** cord length from bracket "A" to float "B" shall be 6".
- Tighten adjustment screw after adjustment.

DWU, DWXU

Troubleshooting Checklist

PROBLEM	POSSIBLE CAUSES
Pump does not run or hums.	<ul style="list-style-type: none"> Line circuit breaker is off, or fuse is blown or loose. Water level in sump has not reached turn-on level as indicated in installation drawing. Pump cord is not making contact in receptacle. Float is stuck. It should operate freely in basin. If all of the above are OK, consult your distributor.
Pump runs but does not deliver water.	<ul style="list-style-type: none"> Check valve is installed backwards. Arrow on valve should point in direction of flow. Discharge shut-off valve (if used) may be closed. Pump is air-locked. Start and stop several times by plugging and unplugging cord. Check for clogged vent hole in pump case. Impeller or volute openings are fully or partially clogged. Remove pump and clean. Vertical pumping distance is too high. Reduce distance or resize pump.
Pump runs and pumps out sump, but does not stop.	<ul style="list-style-type: none"> Float is stuck in up position. Be sure float operates freely in basin. Defective float switch.
Pump runs but delivers only a small amount of water.	<ul style="list-style-type: none"> Pump is air-locked. Start and stop several times by plugging and unplugging cord. Check for clogged vent hole in pump case. Vertical pumping distance is too high. Reduce distance or resize pump. Impeller or volute openings is fully or partially clogged. Remove pump and clean.
Fuse blows or circuit breaker trips when pump starts.	<ul style="list-style-type: none"> Pump impeller is partially clogged causing motor to run slow and overload. Remove pump and clean. Motor stator may be defective. Fuse size or circuit breaker may be too small. Must be 15 amps. Volute opening is fully or partially clogged. Remove pump and clean.
Motor runs for a short time, then stops.	<ul style="list-style-type: none"> Pump impeller is partially clogged causing motor to run slow and overload. Remove pump and clean. Motor stator may be defective. Volute opening is fully or partially clogged. Remove pump and clean.



DWU, DWXU

Sectional View

DW(F)U, DW(F)AU Single Phase Motor

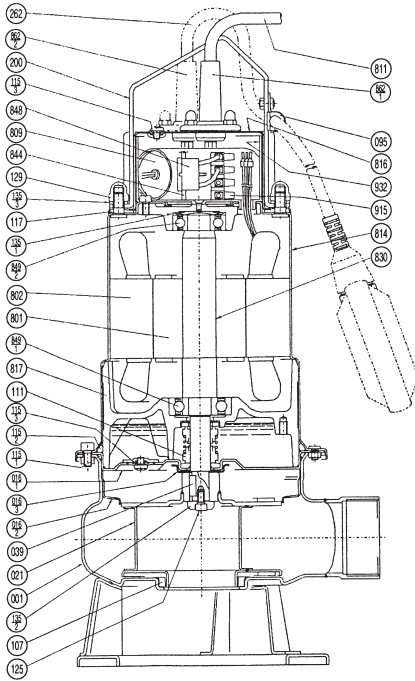

Three Phase Motor

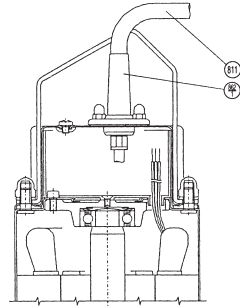

DWX(F)U, DWX(F)AU

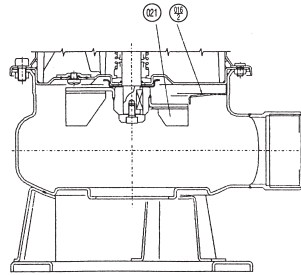

Part No.	Part Name	Material	ASTM, AISI Code	No. for 1 Unit
001	Casing	304 SS	AISI 304	1
016-1	Casing Cover	304 SS	AISI 304	1
016-2	Disk	304 SS	AISI 304	1
016-3	Seal Support	304 SS	AISI 304	1
021	Impeller	304 SS	AISI 304	1
039	Key	304 SS	AISI 304	1
095	Float Switch Stay	—		1
107	Casing Ring	Viton		1
111	Mechanical Seal	—		1 Set
115-1	O-ring	Viton		1
115-2	O-ring	Viton		1
115-3	O-ring	Viton		3
117	Gasket	Viton		1
125	Impeller Bolt	304 SS	AISI 304	1
129	Nut	304 SS	AISI 304	4
135-1	Washer	304 SS	AISI 304	1
135-2	Washer	304 SS	AISI 304	1
135-3	Washer	304 SS	AISI 304	4

Part No.	Part Name	Material	ASTM, AISI Code	No. for 1 Unit
200	Lifting Hanger	304 SS	AISI 304	1
262	Float Switch	—		1
801	Rotor	—		1
802	Stator	—		1
809	Capacitor	—		1
811	Submersible Cable	—		1
814	Motor Frame	304 SS	AISI 304	1
816	Bracket	304 SS	AISI 304	1
817	Bracket	304 SS	AISI 304	1
830	Shaft	304 SS	AISI 304	1
844	Motor Protector Bracket	Plastic		1
848	Motor Protector	—		1
849-1	Ball Bearing	—		1
849-2	Ball Bearing	—		1
862-1	Cable Connector	Rubber (NBR)		1
862-2	Cable Connector	Rubber (NBR)		1
915	External Terminal	—		1
932	Capacitor Holder	Nylon		1

Contact your supplier for spare parts availability.



DWU, DWXU

Disassembly and Assembly

1. Disassembly

When disassembling pump, have a piece of cardboard or wooden board ready to place the different parts on as you work. Do not pile parts on top of each other. They should be laid out neatly in rows. The O-ring and gasket cannot be used again once they are removed. Have replacement parts ready.

Disassemble in the following order, referring to the sectional view.

Be sure to cut off power source before beginning disassembly.

- (1) Loosen casing bolts and remove casing.
- (2) Loosen bolt at end of pump shaft and lift impeller off shaft.
- (3) Remove pump shaft key and mechanical seal.
- (4) Loosen inner casing bolts and remove inner casing.

Note 1: Contaminated oil should be replaced. Drain the lubricant oil into a container.

- (5) Remove the mechanical seal from the main shaft.

Note 2: Be careful not to cut your fingers on the shaft key groove when pulling out the mechanical seal.

Note 3: Be careful not to scratch or bend the pump shaft during disassembly.

2. Assembly

Re-assemble in reverse order of disassembly.

Be careful of the following points.

- (1) During re-assembly, rotate the impeller by hand and check for smooth rotation.
- (2) Replace the O-ring.
- (3) Fill oil chamber with clean mineral oil.
- (4) Replace all parts that are damaged.
- (5) Tighten bolts evenly.

Please obtain O-rings, and other parts from pump dealer.

* All specifications subject to change without notice.

In this catalog, the particulars in { } are in accordance with the International System of Units (SI) and given for reference only.



DWU, DWXU

Warranty

COMMERCIAL PUMP/ PRODUCTS LIMITED WARRANTY

Ebara Pumps Americas Corporation (EPAC) warrants to the original purchaser only ("Customer") that the EPAC Commercial Pump/Product ("Pump") will be free of defects in workmanship and material for a period of twelve (12) months from the date of installation or eighteen (18) months from the date of shipment by EPAC, whichever comes first, provided that notification of any such defect is promptly given in writing to EPAC. Customer may be required at EPAC's request to verify that it is the Customer of the Pump and that the Pump was installed and operated in accordance with EPAC's instructions.

EPAC's sole obligation under this warranty will be to repair or replace with a new or reconditioned Pump, such Pump as has failed or has been found to be defective during the warranty period, or at EPAC's sole option, to refund to the customer an equitable part of the purchase price. In no event shall EPAC's cost responsibility exceed the initial purchase price paid by the Customer for the Pump.

EPAC shall be liable only for the cost of the Pump, or the cost of repair or replacement of any defective Pump. Customer shall be responsible for labor, cost of removal and installation at Customer's premises, transportation and insurance costs to EPAC and any other incidental costs.

This warranty is void and does not apply if damage is caused by improper installation, improper maintenance, accident, alteration, abuse, misuse or if the Pump has been disassembled prior to warranty evaluation without written authorization from EPAC.

Warranty service and information for return procedures will be provided by EPAC upon receipt of written notice describing the defect or problem to:

Ebara Pumps Americas Corporation
Warranty/Claims
1651 Cedar Line Drive Rock Hill, SC 29730
803-327-5005 Phone
803-327-5097 Fax

THE FOREGOING WARRANTY IS THE SOLE AND EXCLUSIVE WARRANTY ON THIS PUMP, AND ALL OTHER WARRANTIES, EXPRESSED OR IMPLIED, INCLUDING ANY WARRANTY OF MERCHANTABILITY OR FITNESS FOR A PARTICULAR PURPOSE, ARE DISCLAIMED AND EXCLUDED FROM THE TERMS OF THIS WARRANTY. EPAC'S SOLE OBLIGATION IN CASE OF ANY DEFECT WILL BE TO PROVIDE THE WARRANTY SERVICE SPECIFIED ABOVE THE FOREGOING IS CUSTOMER'S SOLE AND EXCLUSIVE REMEDY, WHETHER IN CONTRACT, TORT OR OTHERWISE AND EPAC SHALL NOT BE LIABLE FOR ANY CONSEQUENTIAL OR INCIDENTAL DAMAGES OF ANY KIND WHATSOEVER.





Illinois Location:

(847) 841-7867

860 Church Rd Elgin, IL 60123

Minnesota Location:

(651) 758-7867

330 Mill Bay South Suite 1511 Afton, MN 55001

PumpSupplyInc.com

