

EBARA Submersible Propeller Pumps

DSZ3

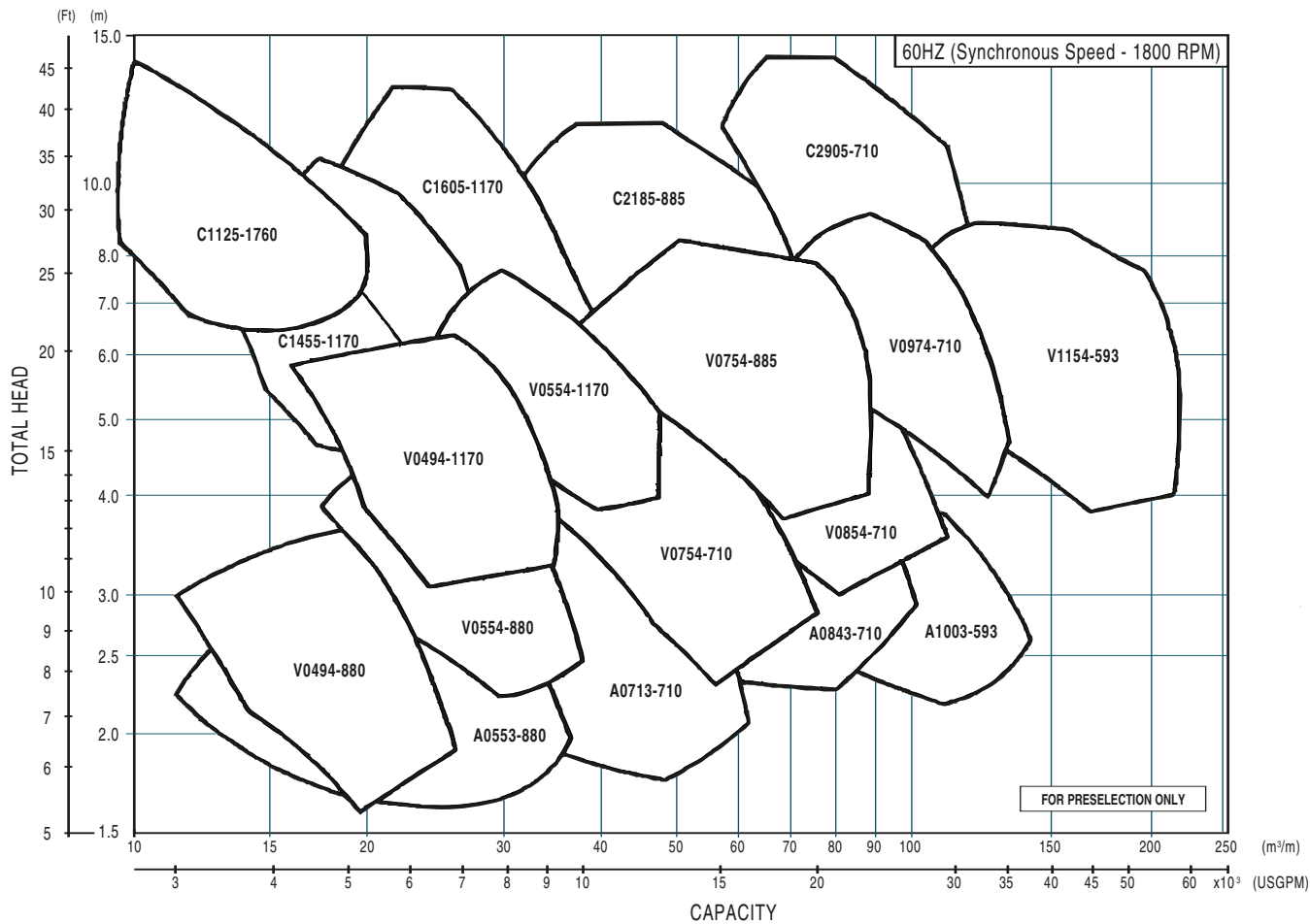

Selection Chart



Illinois Location:
 (847) 841-7867
 860 Church Rd Elgin, IL 60123

Minnesota Location:
 (651) 758-7867
 330 Mill Bay South Suite 1511
 Afton, MN 55001

PumpSupplyInc.com





DSZ3

EBARA Submersible Propeller Pumps

Performance Curves

How to use Performance Curves

Pump Size	Pump Model	Rated Capacity	Total Head	Pump Speed	Motor HP
EBARA Submersible Propeller Pumps					
Performance Curves					
Curve No.	Project:	Chk'd:	Date:		
	Curve No. 40553-80U Rev.0				
Model 400DSZ3	GPM	FT	RPM	HP	r=1.0
	6000	X 18.4	X 880	x40	

Specific gravity of pumping liquid

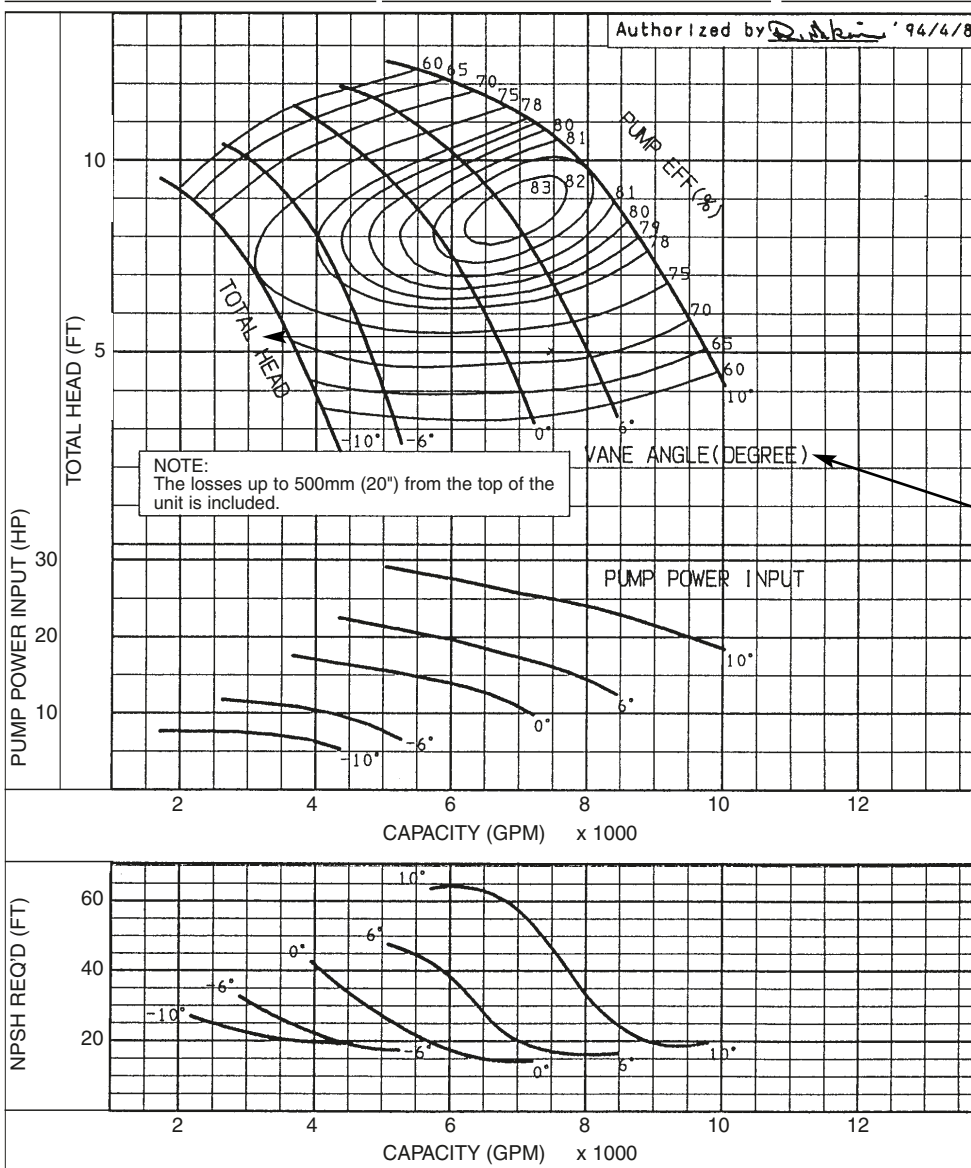

EBARA International Corporation
3-212
rev. 08/01





DSZ3

EBARA Submersible Propeller Pumps

Performance Curves

Project:

Chk'd:

Date:

Curve No: A0553-880U Rev.0

Model	GPM	FT	RPM	HP
	X	X	880	X

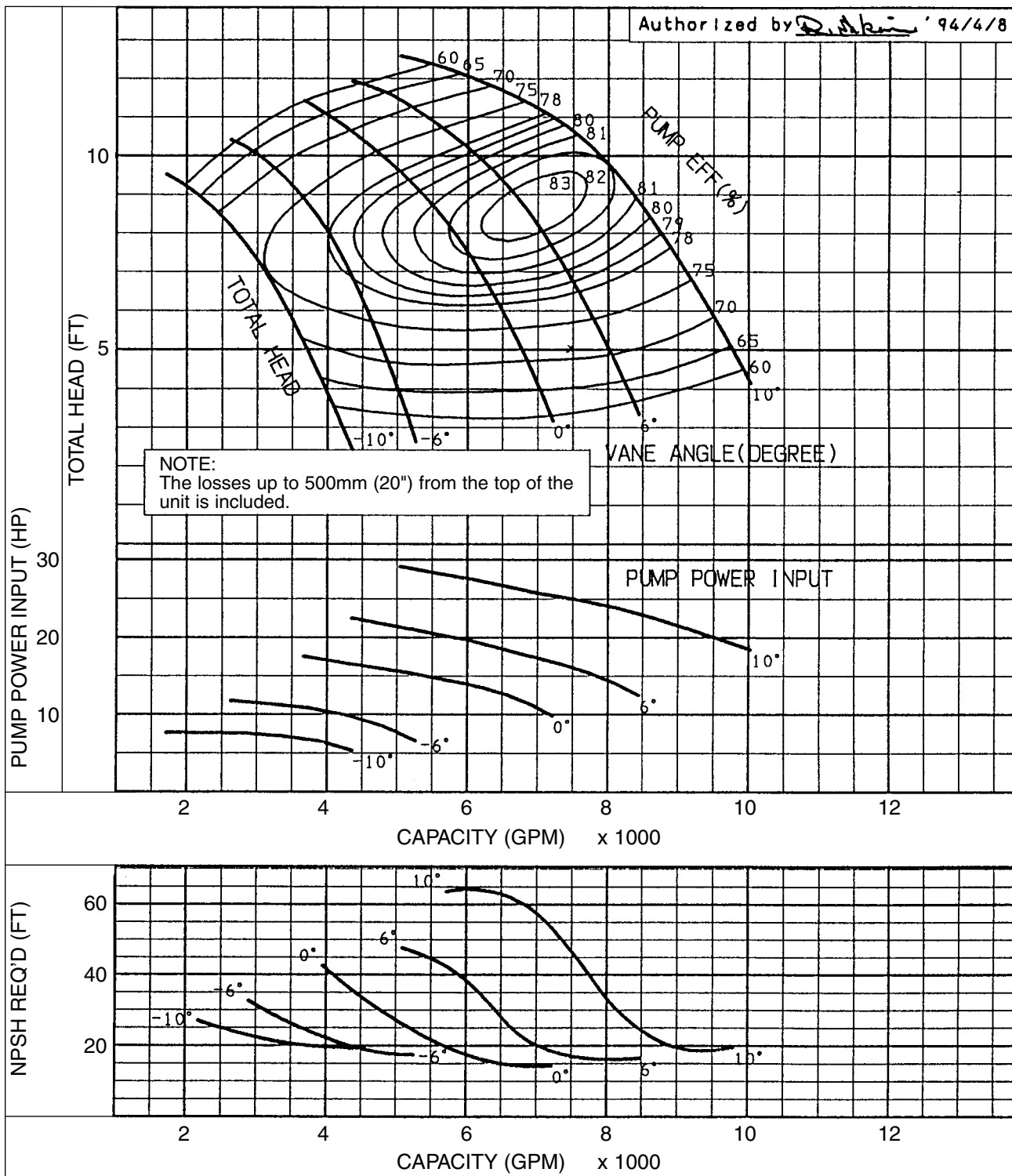



DSZ3

EBARA Submersible Propeller Pumps

Performance Curves

Project:

Chk'd:

Date:

Curve No: A0713-710U Rev.0

Model	GPM	FT	RPM	HP
	X	X	710	X

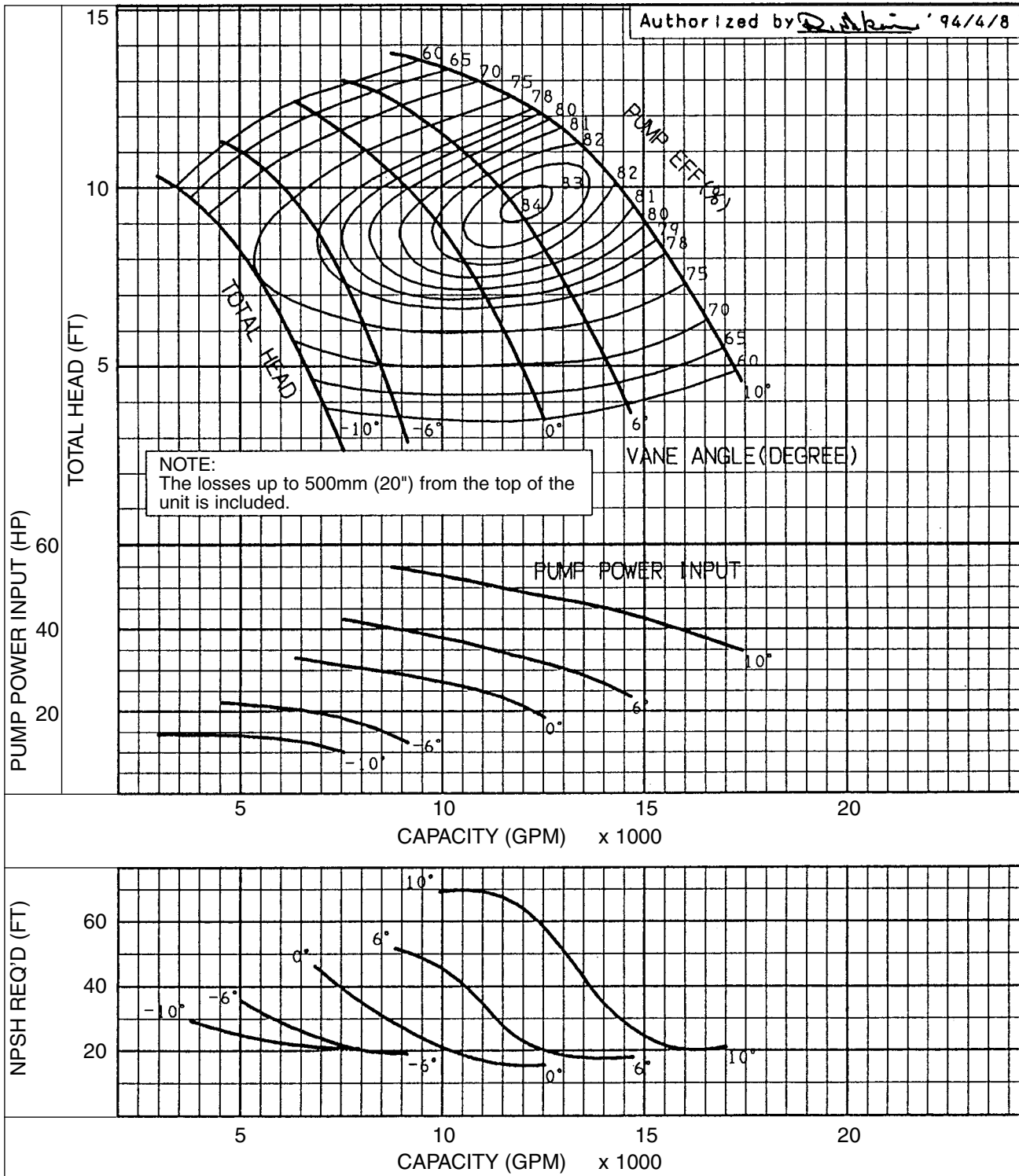



DSZ3

EBARA Submersible Propeller Pumps

Performance Curves

Project:

Chk'd:

Date:

Curve No: A0843-710U Rev.0

Model	GPM	FT	RPM	HP
	X	X	710	X

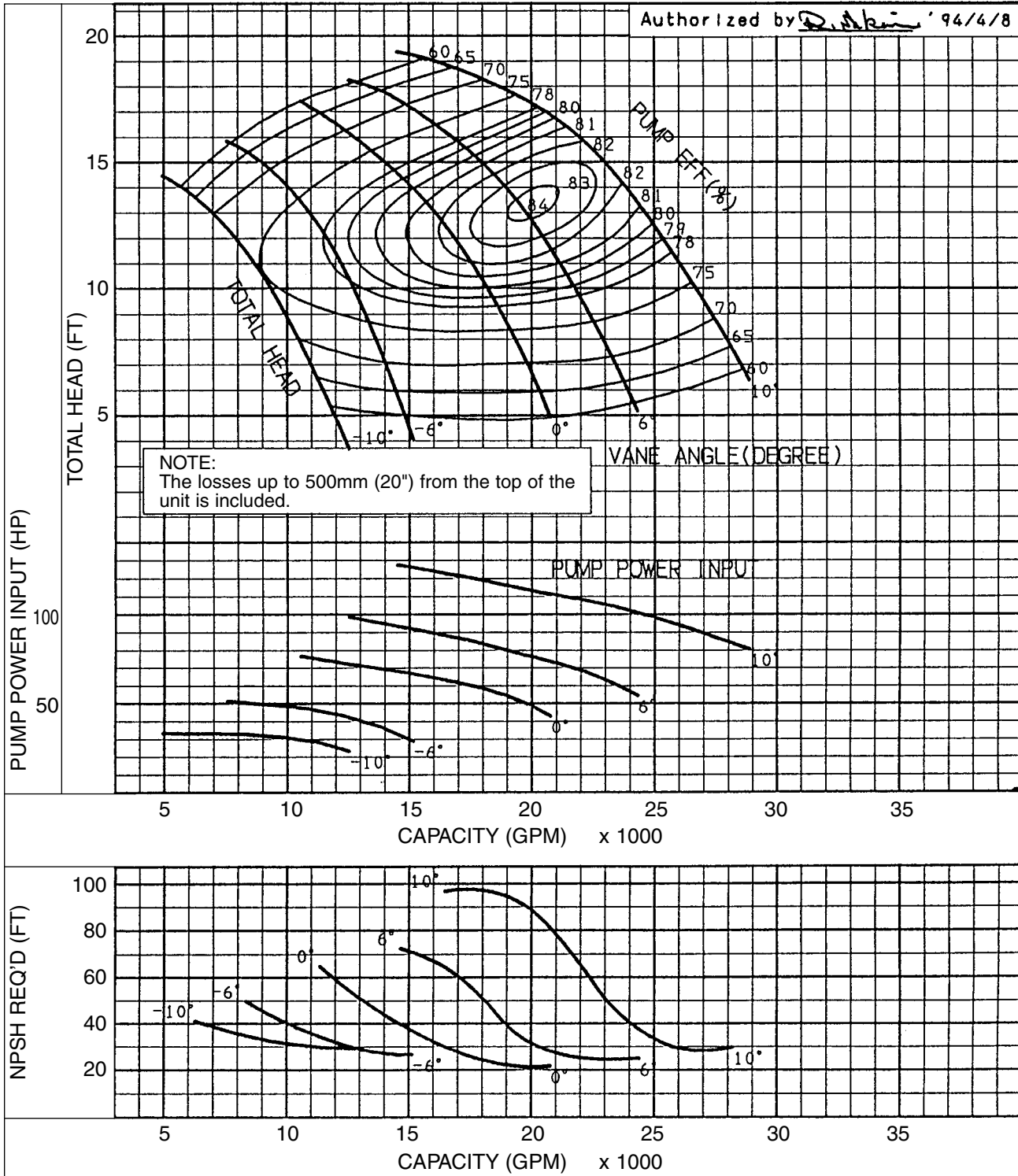



DSZ3

EBARA Submersible Propeller Pumps

Performance Curves

Project:

Chk'd:

Date:

Curve No: A1003-593U Rev.0

Model	GPM	FT	RPM	HP
	X	X	593	X

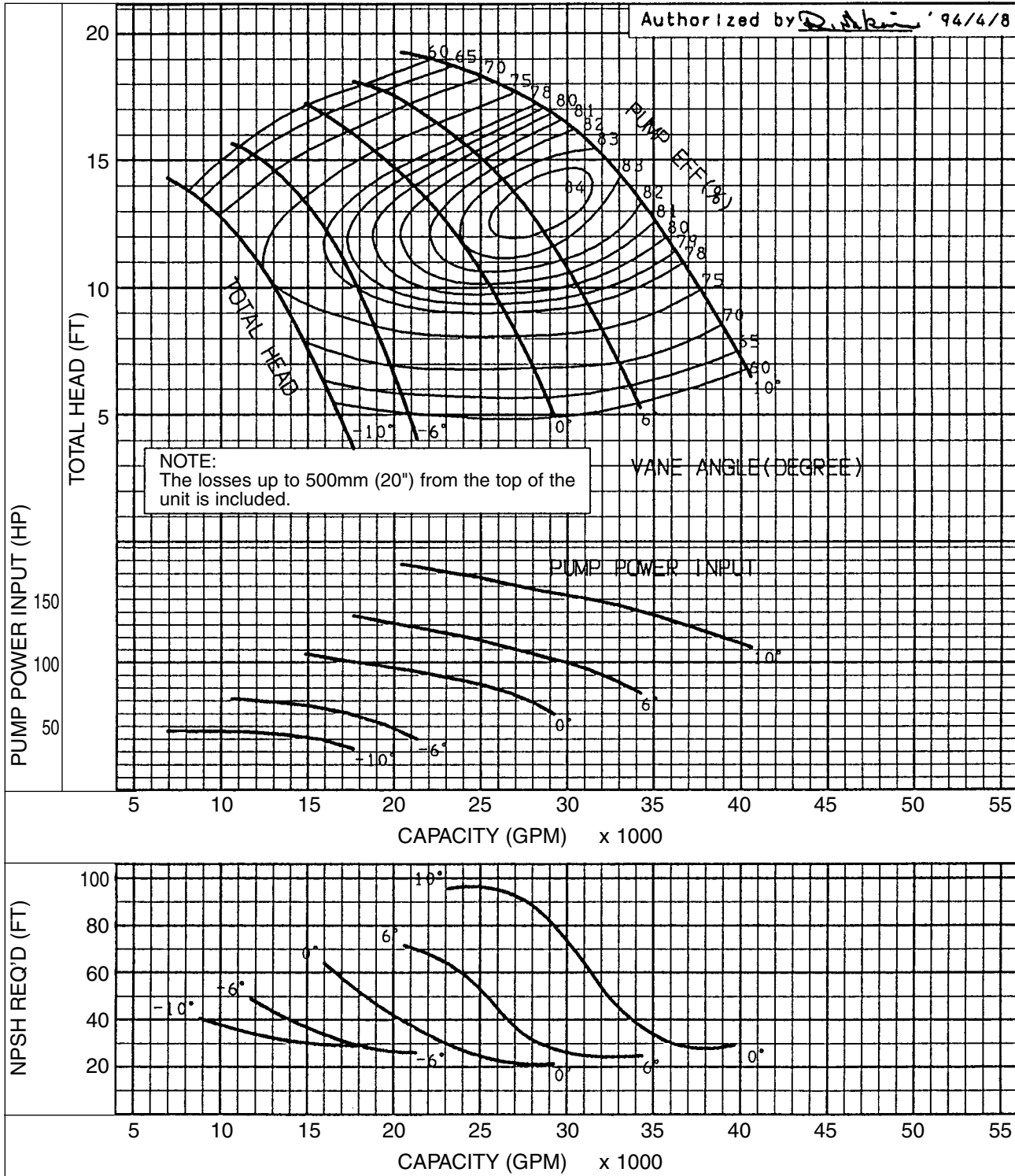



DSZ3

EBARA Submersible Propeller Pumps

Performance Curves

Project:

Chk'd:

Date:

Curve No: C1125-1760U Rev.0

Model	GPM	FT	RPM	HP
	X	X	1760	X

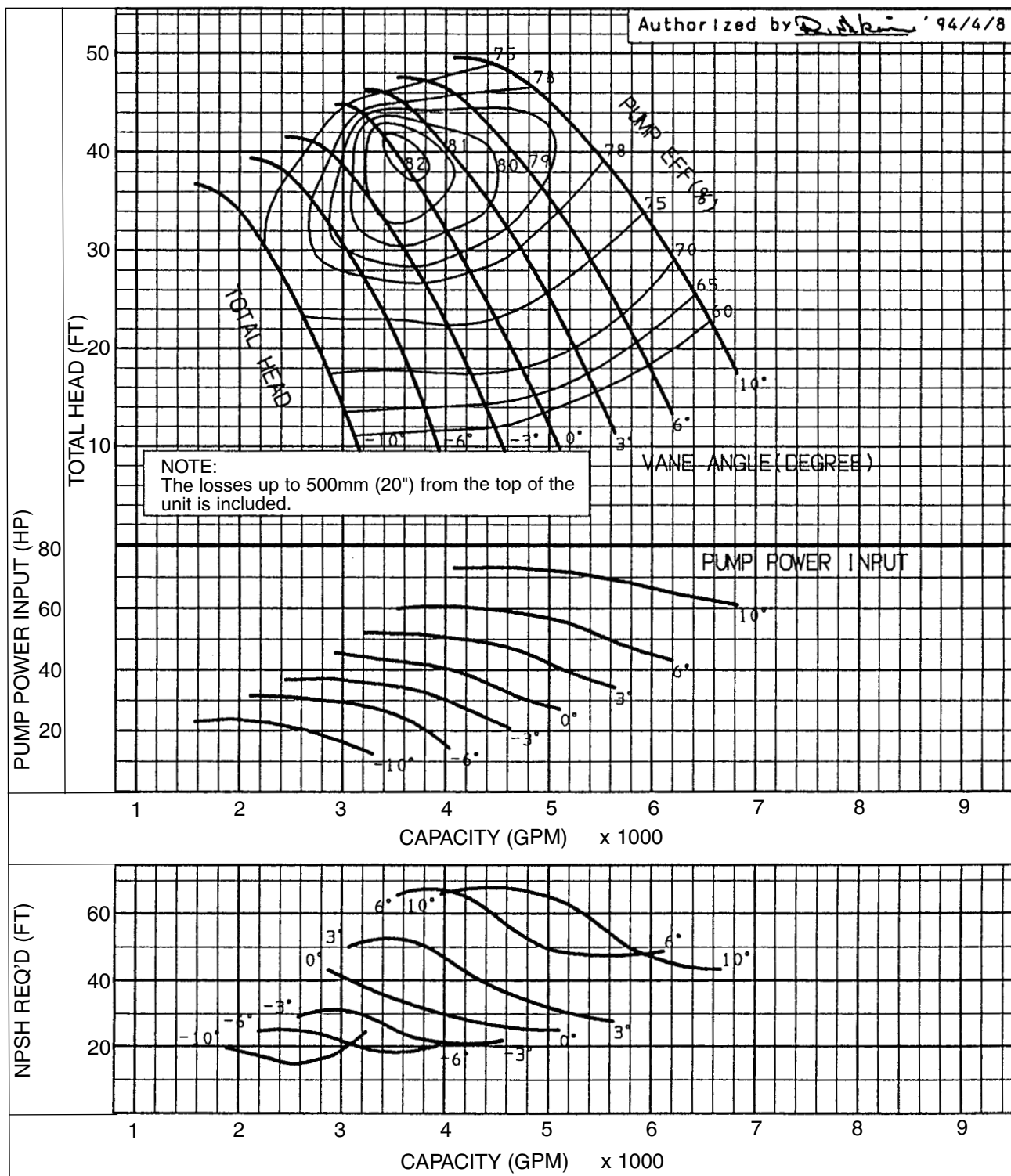

3-216
rev. 01/02



DSZ3

EBARA Submersible Propeller Pumps

Performance Curves

Project:

Chk'd:

Date:

Curve No: C1455-1170U Rev.0

Model	GPM	FT	RPM	HP
	X	X	1170	X

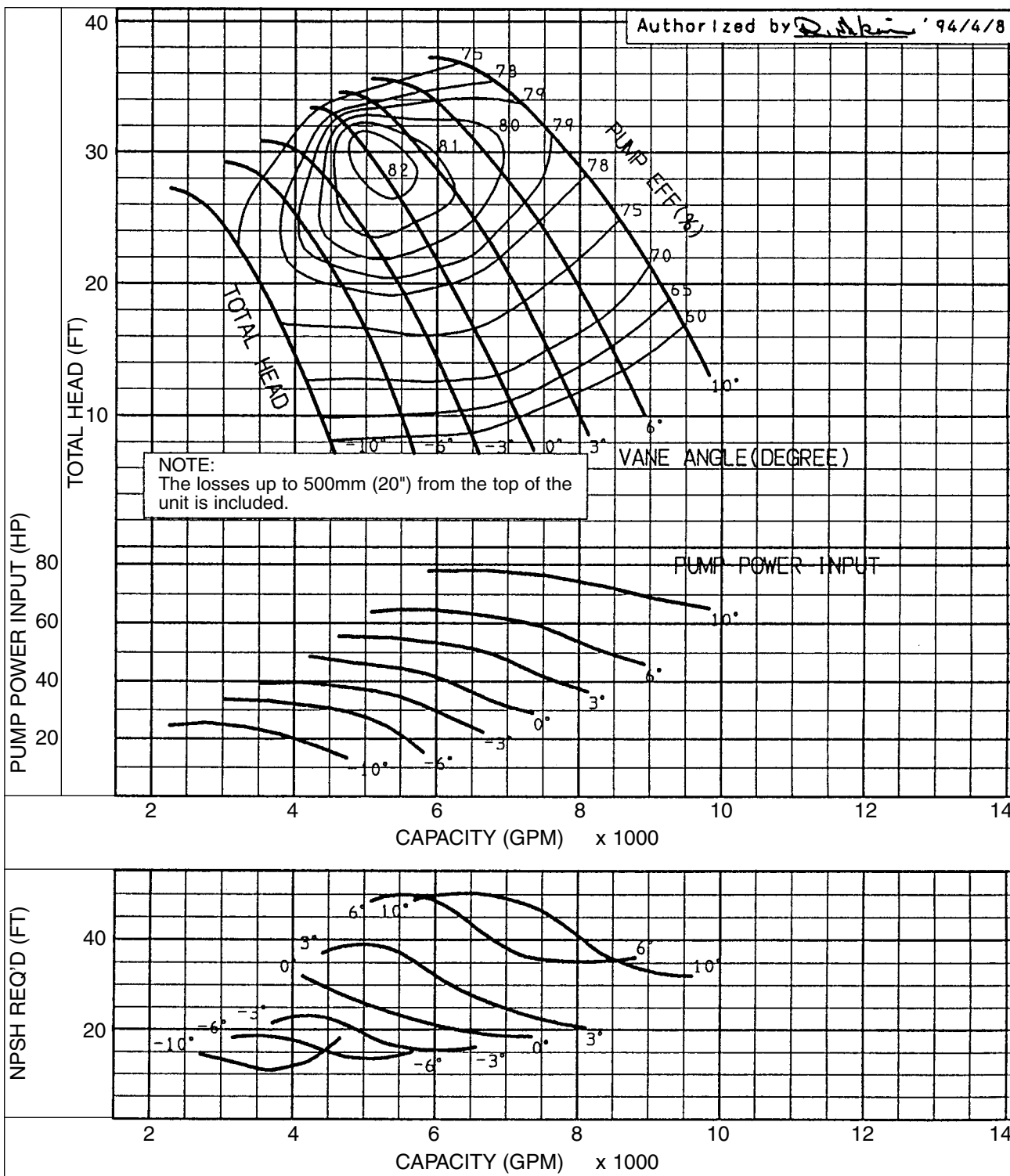



DSZ3

EBARA Submersible Propeller Pumps

Performance Curves

Project:

Chk'd:

Date:

Curve No: C1605-1170U Rev.0

Model

GPM

FT

RPM

HP

X

X

1170

X

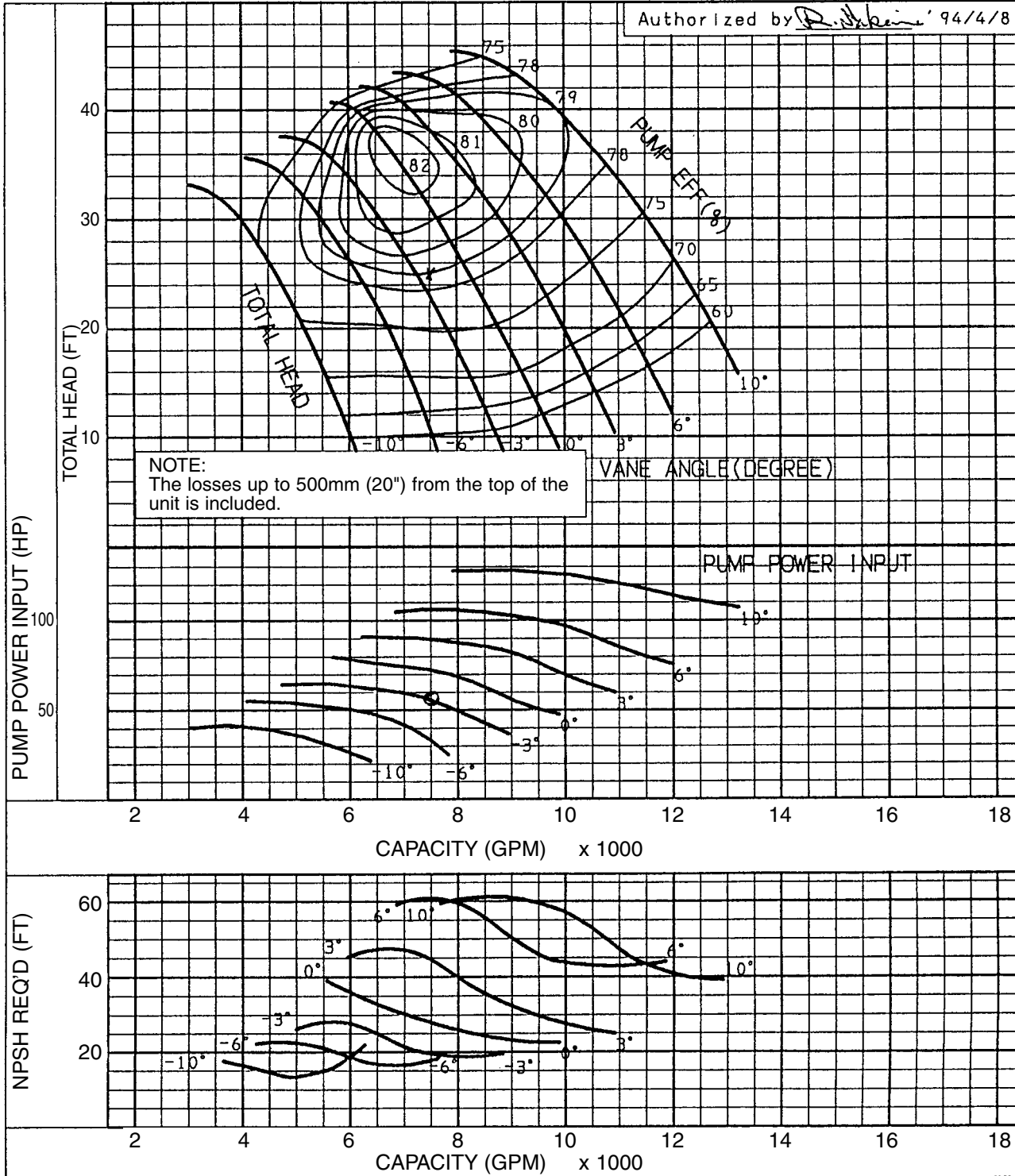



DSZ3

EBARA Submersible Propeller Pumps

Performance Curves

Project:

Chk'd:

Date:

Curve No: C2185-885U Rev.0

Model	GPM	FT	RPM	HP
	X	X	885	X

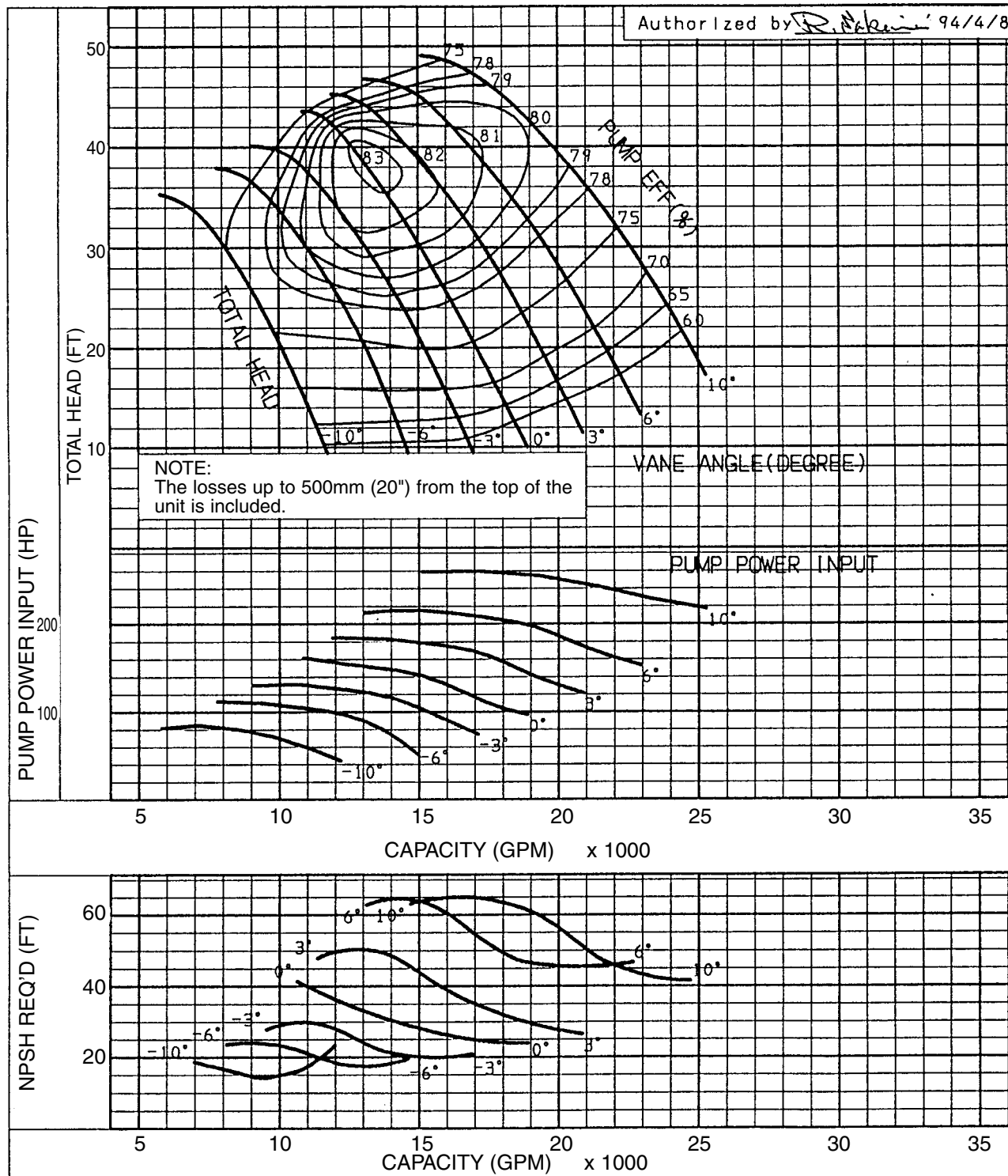



DSZ3

EBARA Submersible Propeller Pumps

Performance Curves

Project:

Chk'd:

Date:

Curve No: C2905-710U Rev.0

Model	GPM	FT	RPM	HP
	X	X	710	X

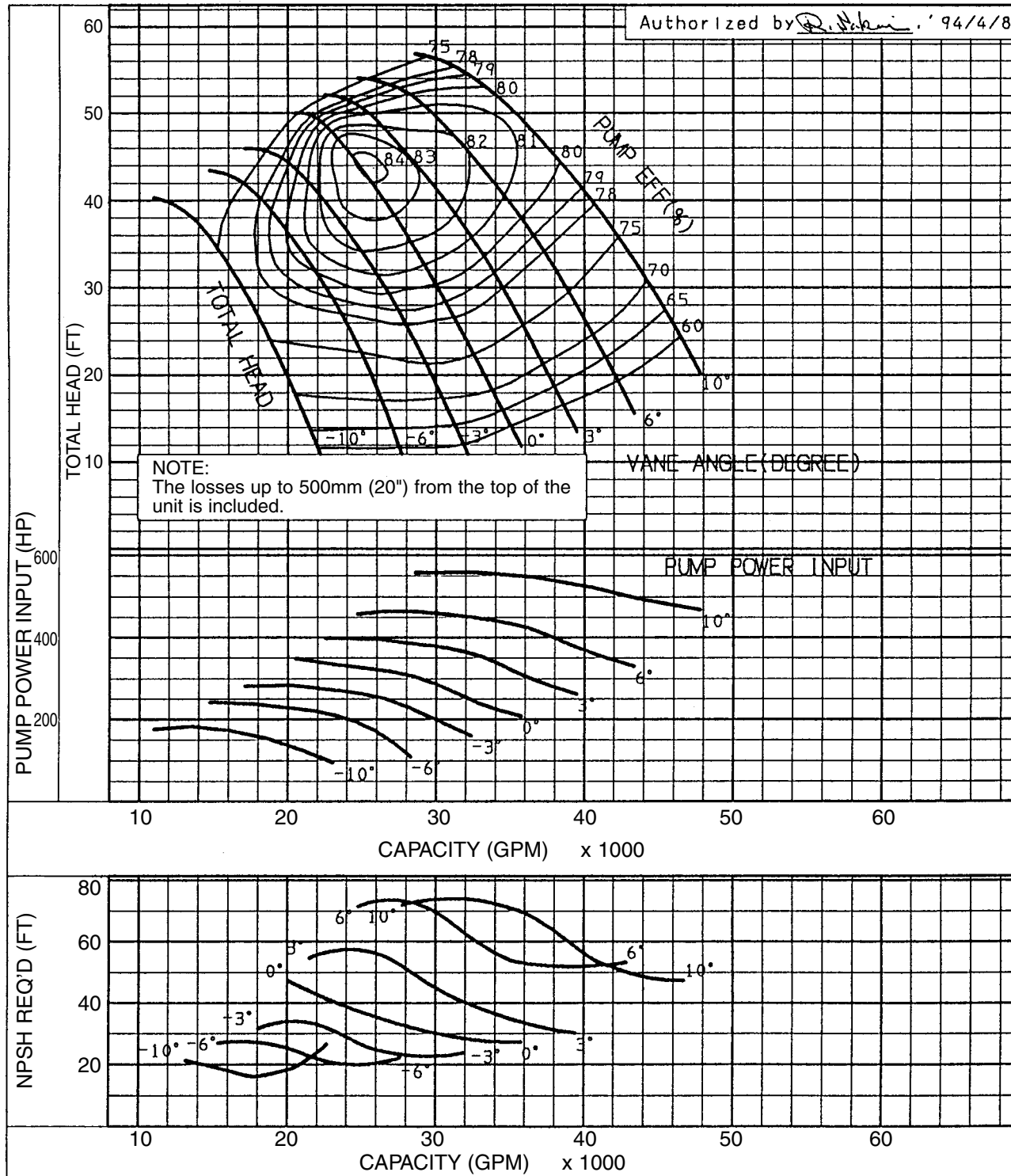



DSZ3

EBARA Submersible Propeller Pumps

Performance Curves

Project:

Chk'd:

Date:

Curve No: V0494-880U Rev.0

Model	GPM	FT	RPM	HP
	X	X	880	X

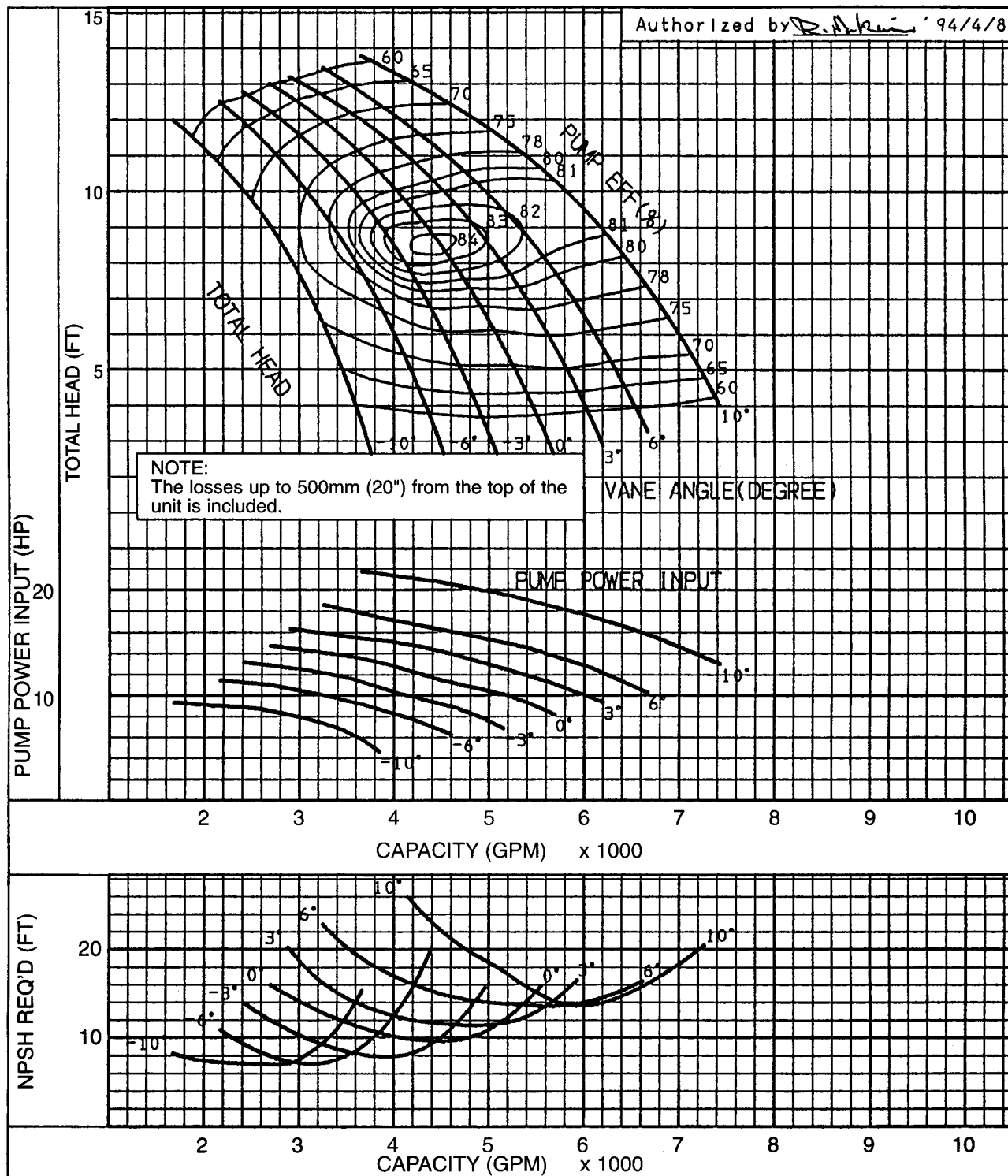



DSZ3

EBARA Submersible Propeller Pumps

Performance Curves

Project:

Chk'd:

Date:

Curve No: V0494-1170U Rev.0

Model	GPM	FT	RPM	HP
	X	X	1170	X

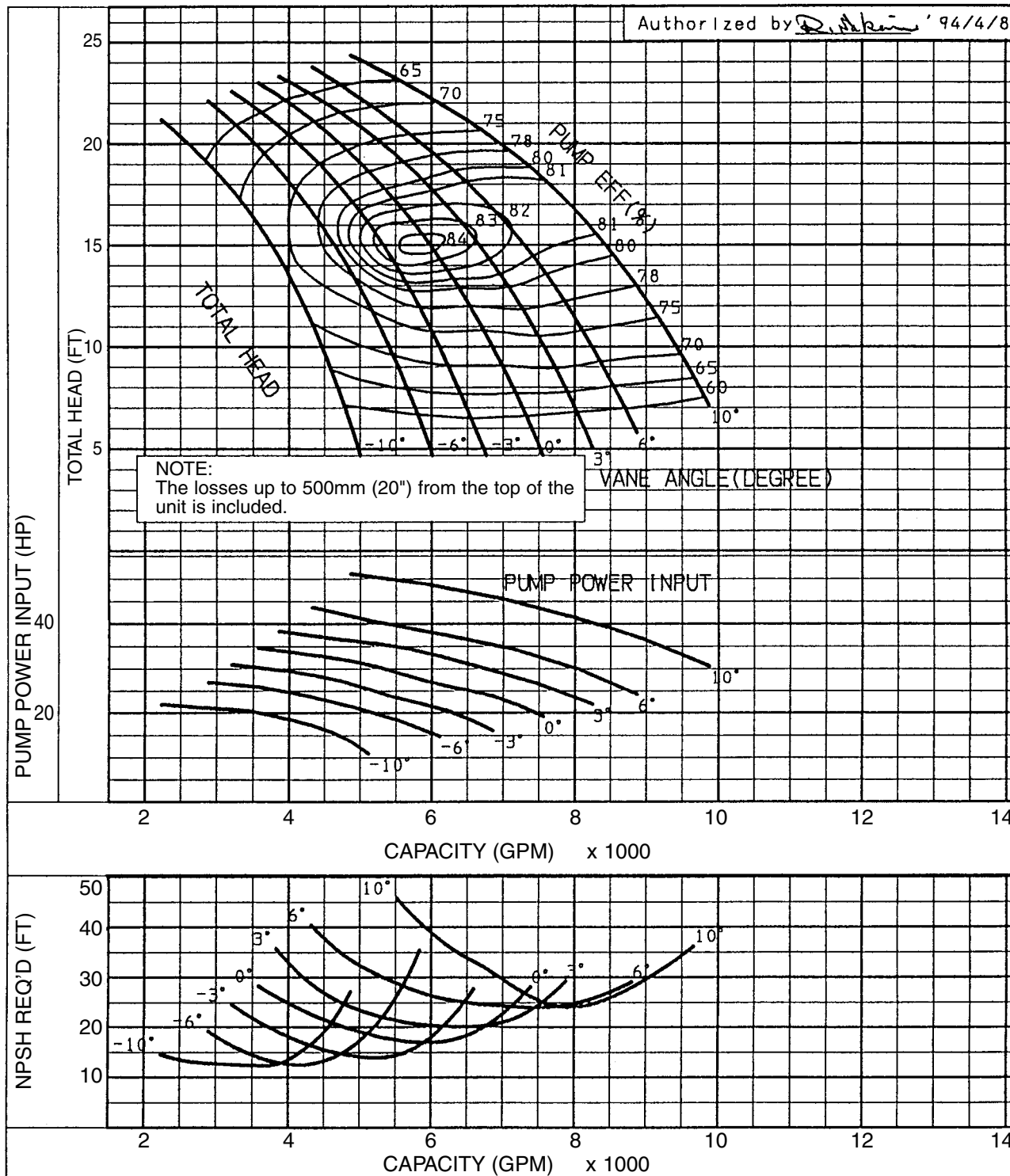



DSZ3

EBARA Submersible Propeller Pumps

Performance Curves

Project:

Chk'd:

Date:

Curve No: V0554-880U Rev.0

Model	GPM	FT	RPM	HP
	X	X	880	X

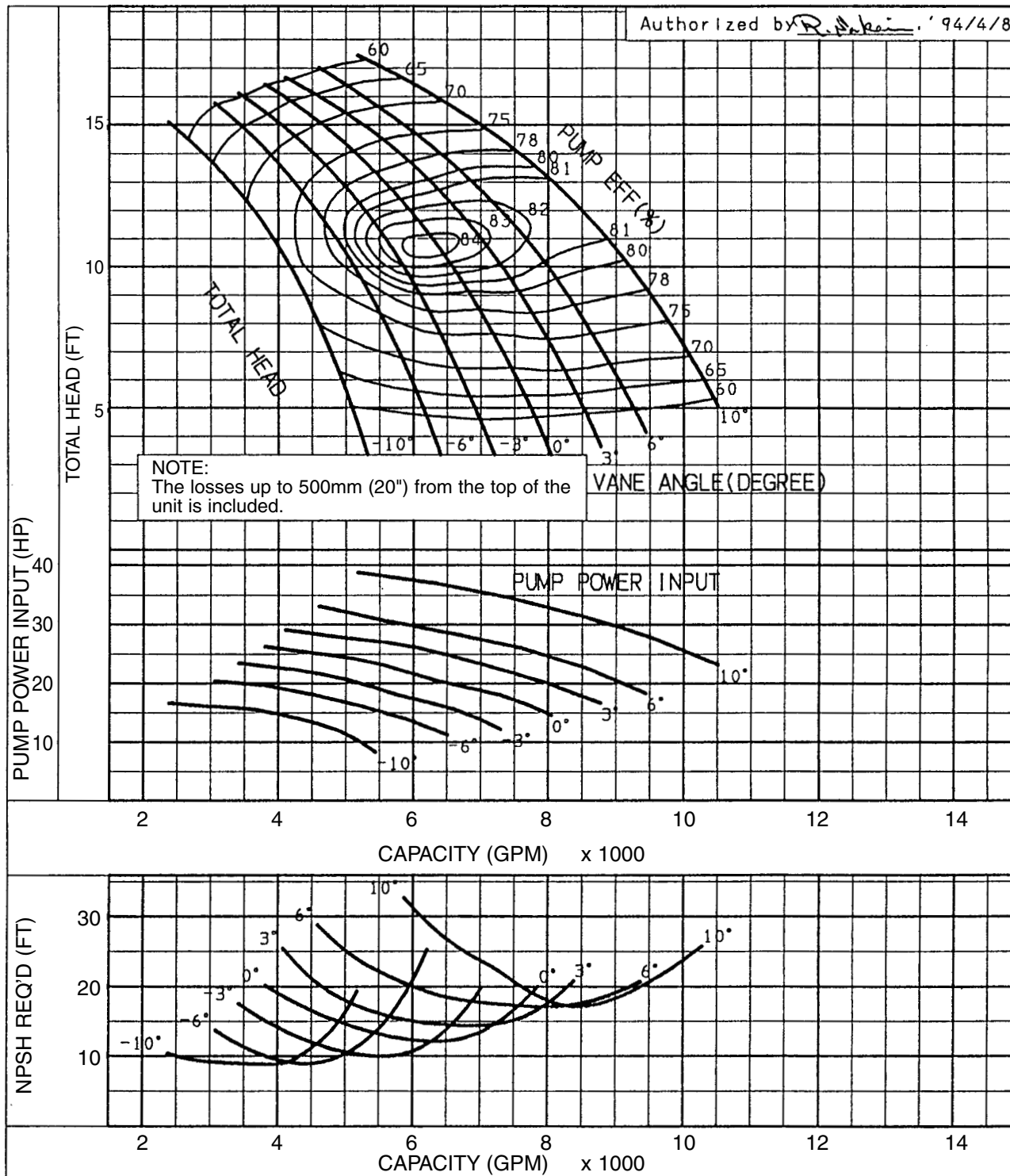



DSZ3

EBARA Submersible Propeller Pumps

Performance Curves

Project:

Chk'd:

Date:

Curve No: V0554-1170U Rev.0

Model	GPM	FT	RPM	HP
	X	X	1170	X

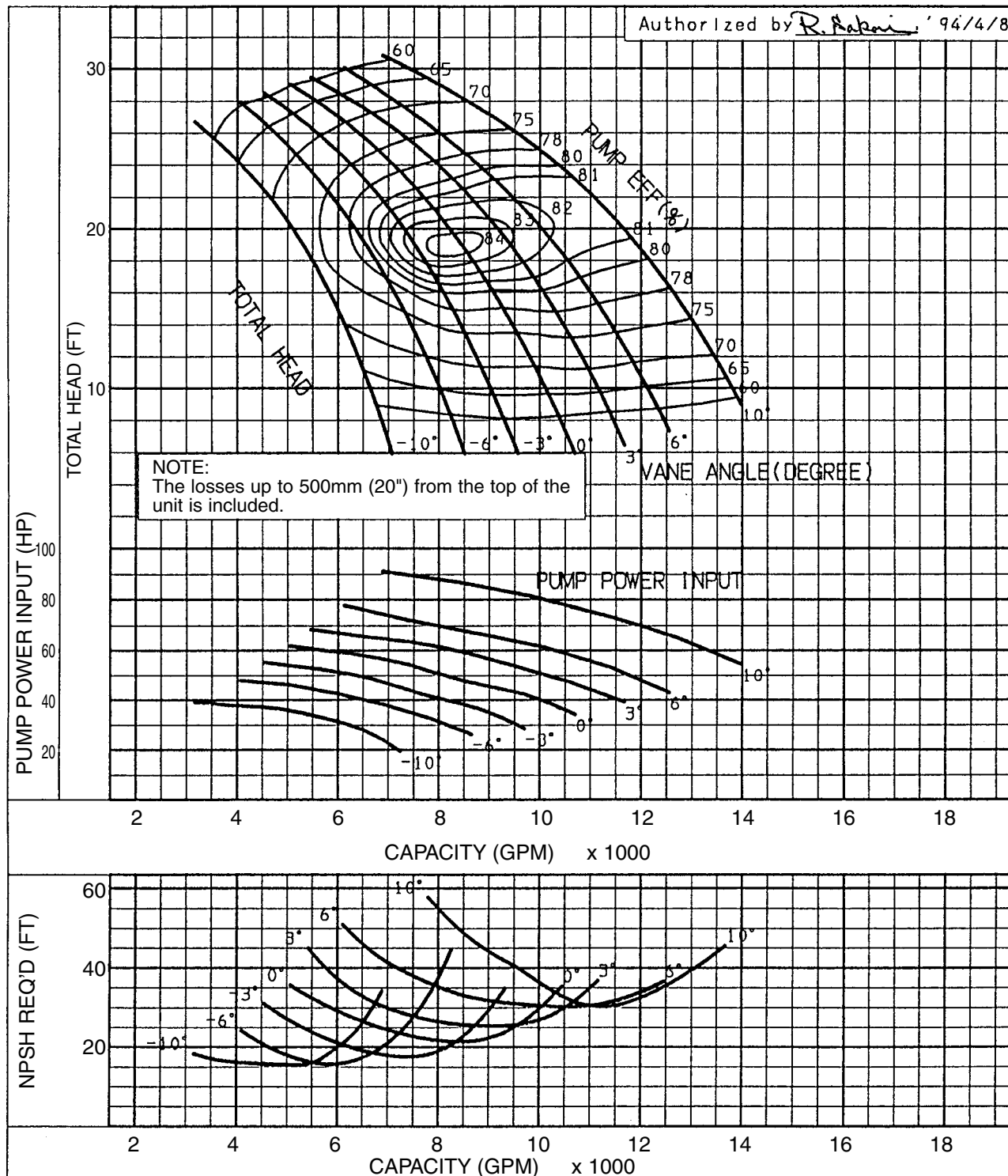



DSZ3

EBARA Submersible Propeller Pumps

Performance Curves

Project:

Chk'd:

Date:

Curve No: V0754-710U Rev.0

Model	GPM	FT	RPM	HP
	X	X	710	X

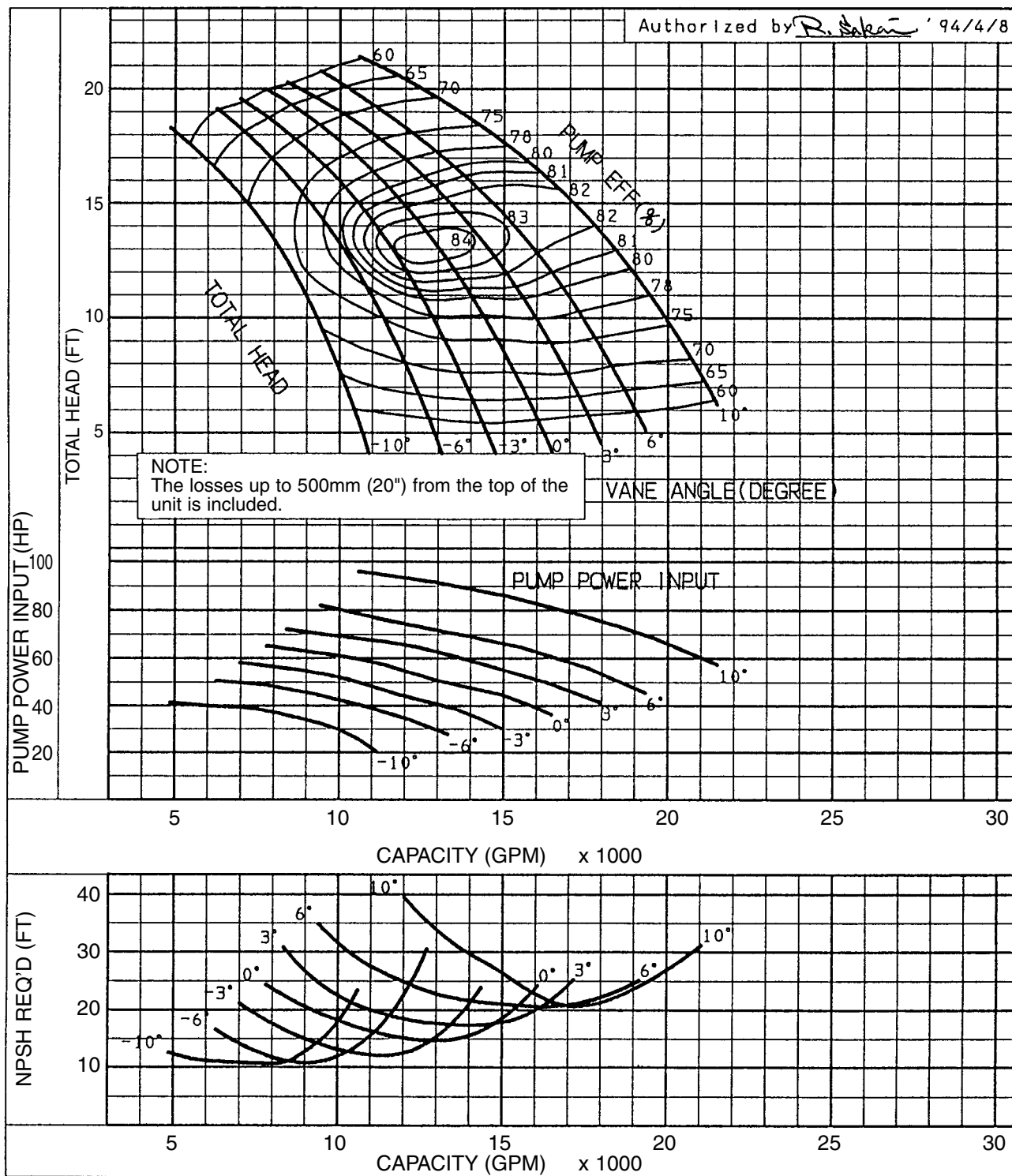



DSZ3

EBARA Submersible Propeller Pumps

Performance Curves

Project:

Chk'd:

Date:

Curve No: V0754-885U Rev.0

Model	GPM	FT	RPM	HP
	X	X	885	X

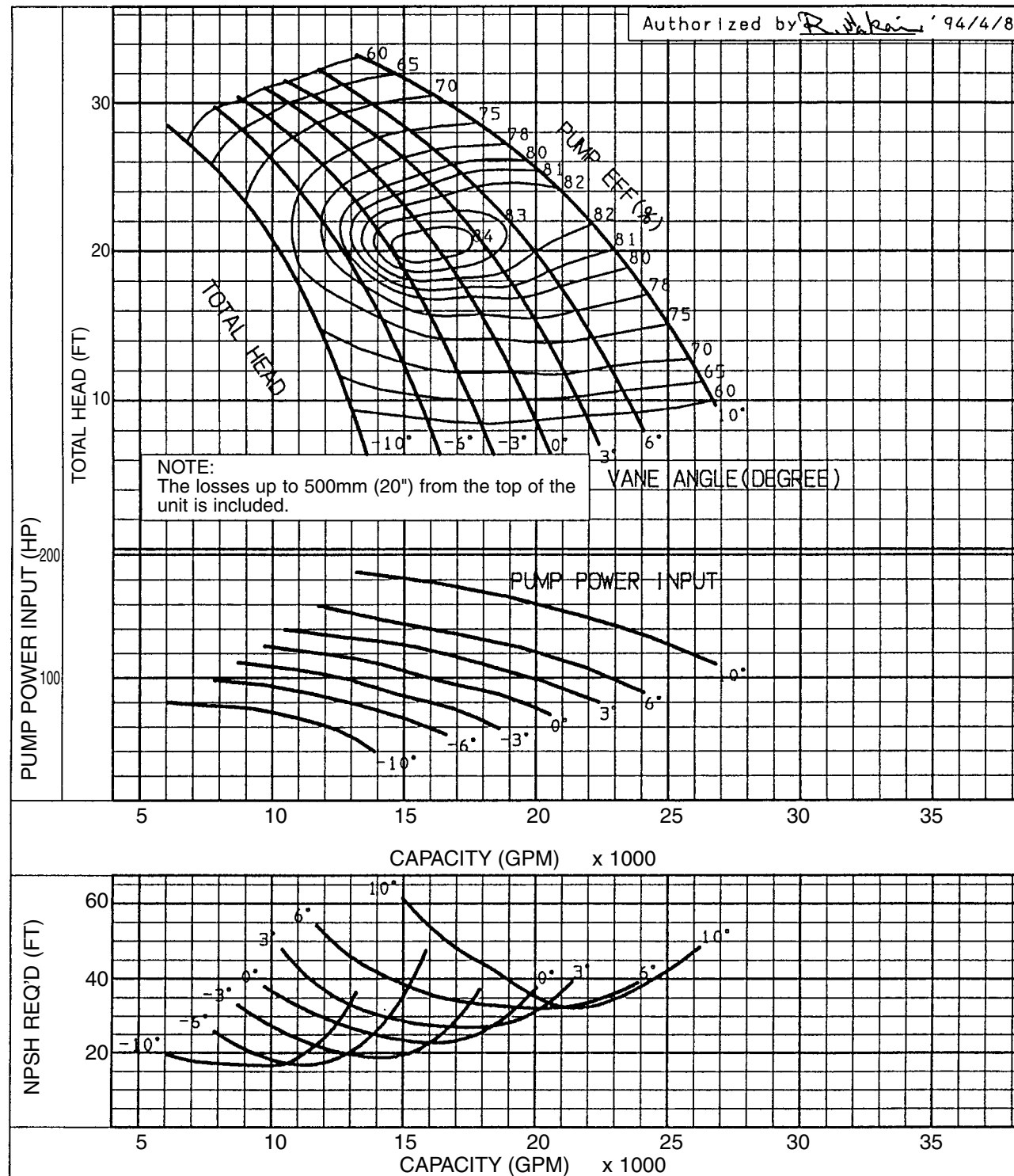



DSZ3

EBARA Submersible Propeller Pumps

Performance Curves

Project:

Chk'd:

Date:

Curve No: V0854-710U Rev.0

Model	GPM	FT	RPM	HP
	X	X	710	X

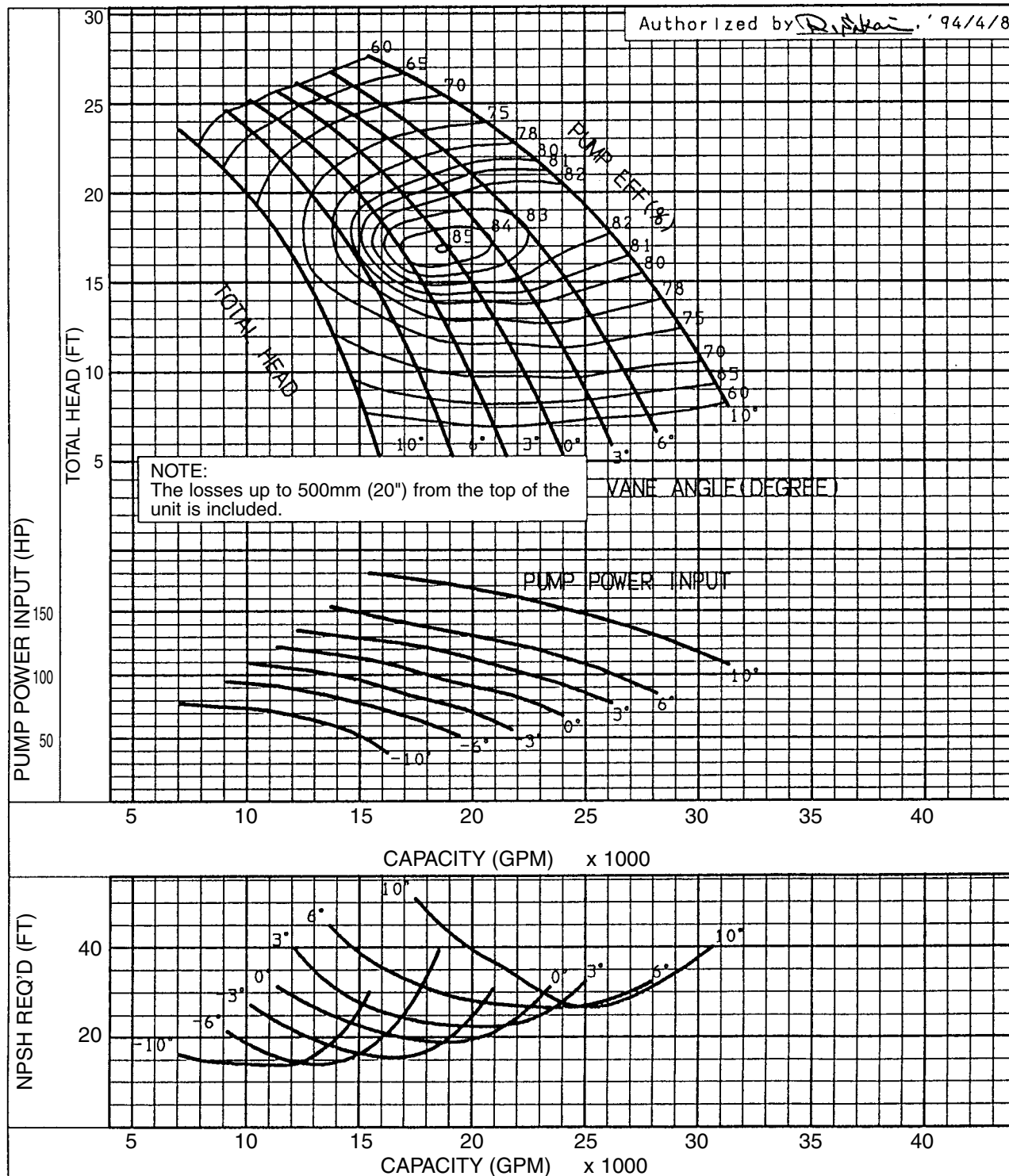



DSZ3

EBARA Submersible Propeller Pumps

Performance Curves

Project:

Chk'd:

Date:

Curve No: V0974-710U Rev.0

Model	GPM	FT	RPM	HP
	X	X	710	X

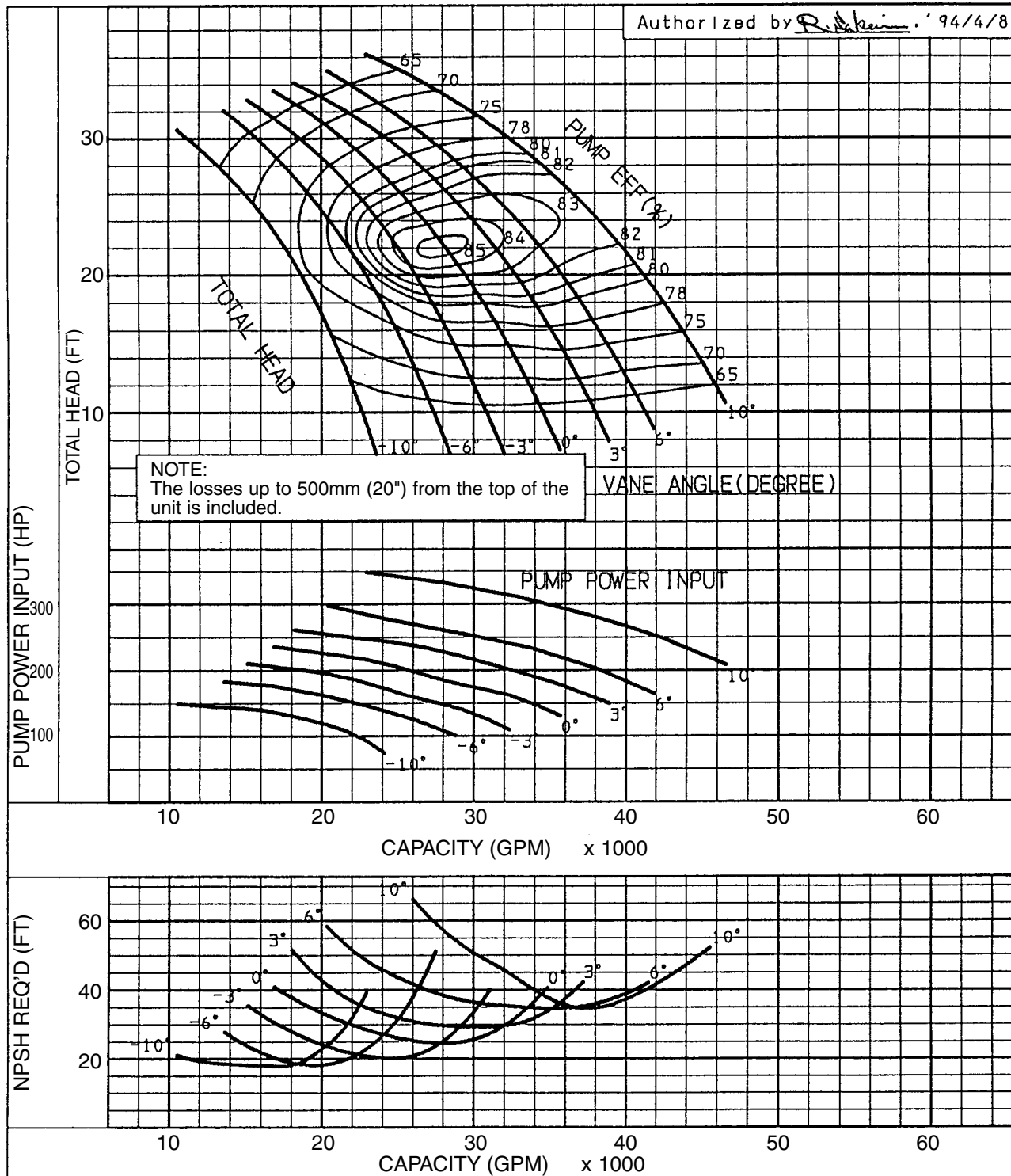



DSZ3

EBARA Submersible Propeller Pumps

Performance Curves

Project:

Chk'd:

Date:

Curve No: V1154-593U Rev.0

Model	GPM	FT	RPM	HP
	X	X	593	X

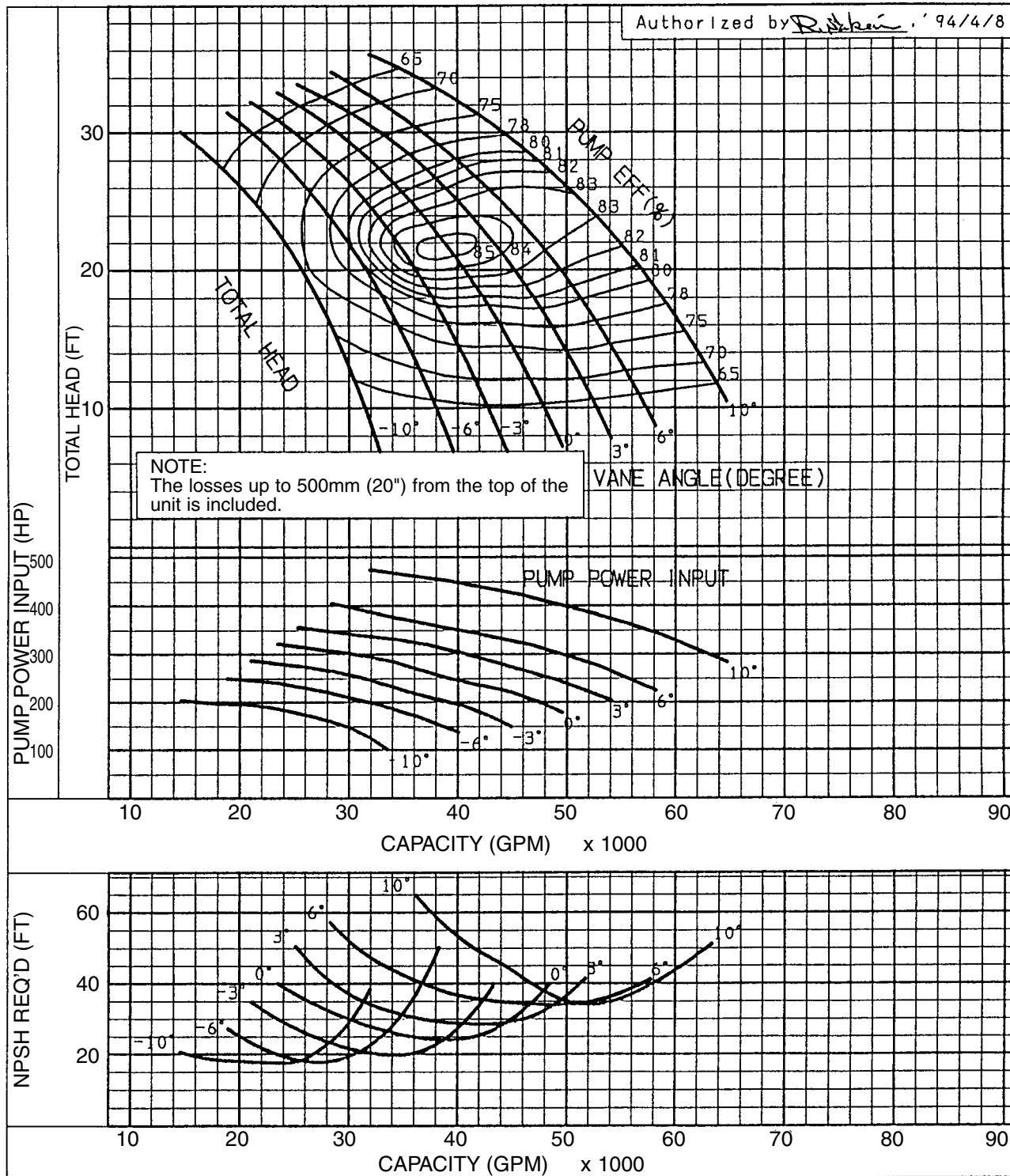



DSZ3

EBARA Submersible Propeller Pumps

Dimensions

Project: _____ Model: _____ Chk'd: _____ Date: _____

Apply to Model A0553, A0713, A0843, A1003

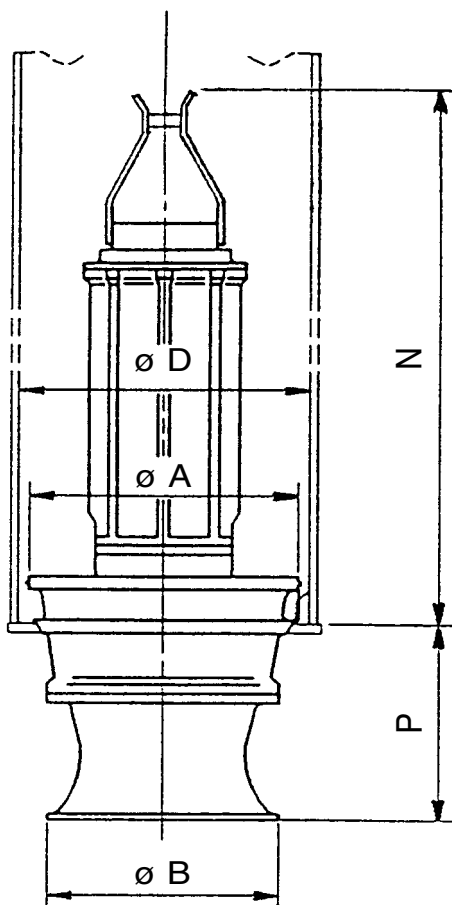

Dimensions: inch

Model (Pole)	HP	Pump & Motor					Column Pipe Dia. D (†2)	Weight Lbs (†1)
		A (†2)	B	P	N			
A0553-880 (8 POLES)	10	Contact EBARA						
	15							
	20							
	25	26 ³ / ₄	21 ¹ / ₄	16 ¹ / ₈	58 ¹ / ₄	28	1631	
A0713-710 (10 POLES)	25	34 ⁵ / ₈	24 ¹³ / ₁₆	19 ¹¹ / ₁₆	70 ¹ / ₂	36	2778	
	30	34 ⁵ / ₈	24 ¹³ / ₁₆	19 ¹¹ / ₁₆	70 ¹ / ₂	36	2778	
	40	34 ⁵ / ₈	24 ¹³ / ₁₆	19 ¹¹ / ₁₆	70 ¹ / ₂	36	2866	
	50	34 ⁵ / ₈	24 ¹³ / ₁₆	19 ¹¹ / ₁₆	70 ¹ / ₂	36	2932	
A0843-710 (10 POLES)	50	34 ⁵ / ₈	28 ³ / ₄	20 ¹¹ / ₁₆	72 ¹³ / ₁₆	36	3175	
	60	34 ⁵ / ₈	28 ³ / ₄	20 ¹¹ / ₁₆	78 ³ / ₄	36	3395	
	75	40 ⁹ / ₁₆	28 ³ / ₄	25 ⁹ / ₁₆	74	42	3770	
	100	40 ⁹ / ₁₆	28 ³ / ₄	25 ⁹ / ₁₆	87 ³ / ₈	42	4696	
A1003-593 (12 POLES)	75	40 ⁹ / ₁₆	34 ¹ / ₄	23 ⁵ / ₈	90 ¹⁵ / ₁₆	42	5137	
	100	46 ⁷ / ₁₆	34 ¹ / ₄	24 ¹³ / ₁₆	89 ³ / ₄	48	5622	
	120	46 ⁷ / ₁₆	34 ¹ / ₄	24 ¹³ / ₁₆	93 ¹¹ / ₁₆	48	5930	

Dimensions: mm

Model (Pole)	KW	Pump & Motor					Column Pipe Dia. D (†2)	Weight kgf (†1)
		A (†2)	B	P	N			
A0553-880 (8 POLES)	7.5	Contact EBARA						
	11							
	15							
	18.5	680	540	410	1480	700	740	
A0713-710 (10 POLES)	18.5	880	630	500	1790	900	1260	
	22	880	630	500	1790	900	1260	
	30	880	630	500	1790	900	1300	
	37	880	630	500	1790	900	1330	
A0843-710 (10 POLES)	37	880	730	525	1850	900	1440	
	45	880	730	525	2000	900	1540	
	55	1030	730	650	1880	1050	1710	
	75	1030	730	650	2220	1050	2130	
A1003-593 (12 POLES)	55	1030	870	600	2310	1050	2330	
	75	1180	870	630	2280	1200	2550	
	90	1180	870	630	2380	1200	2690	

Dimensions are Approximate

Note:

†1 Includes weight of 33 ft. standard length cables.

†2 Consult EBARA if smaller diameter is required.





DSZ3

EBARA Submersible Propeller Pumps

Dimensions

Project: _____ Model: _____ Chk'd: _____ Date: _____

Apply to Model C1125, C1455, C1605 C2185, C2905

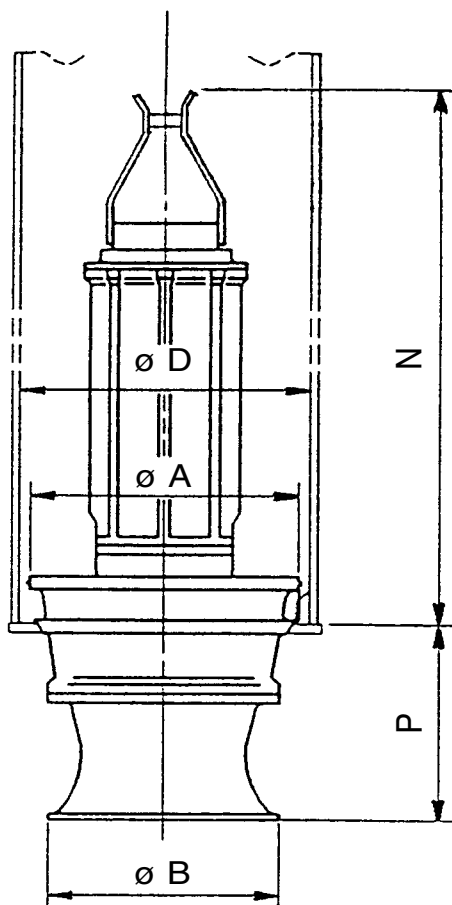

Dimensions: inch

Model (Pole)	HP	Pump & Motor					Column Pipe Dia. D	Weight Lbs (†1)
		A	B	P	N			
C1125-1760 (4 POLES)	30	Contact EBARA						
	40	Contact EBARA						
	50	22 ¹³ / ₁₆	15 ³ / ₄	14 ⁹ / ₁₆	57 ¹ / ₂	24	1433	
C1455-1170 (6 POLES)	30	Contact EBARA						
	40	22 ¹³ / ₁₆	18 ¹ / ₈	15 ³ / ₁₆	59 ¹ / ₁₆	24	1543	
	50	22 ¹³ / ₁₆	18 ¹ / ₈	15 ³ / ₁₆	59 ¹ / ₁₆	24	1587	
C1605-1170 (6 POLES)	60	22 ¹³ / ₁₆	18 ¹ / ₈	15 ³ / ₁₆	62 ³ / ₁₆	24	1653	
	75	26 ³ / ₄	21 ¹ / ₄	17 ¹ / ₂	62 ⁵ / ₈	28	1896	
	100	26 ³ / ₄	21 ¹ / ₄	17 ¹ / ₂	70 ¹ / ₂	28	2646	
C2185-885 (8 POLES)	100	34 ⁵ / ₈	28 ³ / ₄	23 ⁵ / ₈	76	36	3660	
	120	34 ⁵ / ₈	28 ³ / ₄	23 ⁵ / ₈	89	36	4475	
	145	34 ⁵ / ₈	28 ³ / ₄	23 ⁵ / ₈	89	36	4630	
C2905-710 (10 POLES)	175	38 ⁹ / ₁₆	28 ³ / ₄	23 ⁵ / ₈	89	40	4982	
	200	46 ⁷ / ₁₆	39 ³ / ₈	31 ¹¹ / ₁₆	89 ³ / ₄	48	8400	
	215	46 ⁷ / ₁₆	39 ³ / ₈	31 ¹¹ / ₁₆	89 ³ / ₄	48	8422	
	245	46 ⁷ / ₁₆	39 ³ / ₈	31 ¹¹ / ₁₆	97 ⁵ / ₈	48	8730	
	265	46 ⁷ / ₁₆	39 ³ / ₈	31 ¹¹ / ₁₆	97 ⁵ / ₈	48	8907	
	295	46 ⁷ / ₁₆	39 ³ / ₈	31 ¹¹ / ₁₆	97 ⁵ / ₈	48	8929	
	335	46 ⁷ / ₁₆	39 ³ / ₈	31 ¹¹ / ₁₆	97 ⁵ / ₈	48	9348	

Dimensions: mm

Model (Pole)	KW	Pump & Motor					Column Pipe Dia. D	Weight kgf (†1)
		A	B	P	N			
C1125-1760 (4 POLES)	22	Contact EBARA						
	30	Contact EBARA						
	37	580	400	370	1460	600	650	
C1455-1170 (6 POLES)	22	Contact EBARA						
	30	580	460	385	1500	600	700	
	37	580	460	385	1500	600	720	
C1605-1170 (6 POLES)	45	580	460	385	1580	600	750	
	55	680	540	445	1590	700	860	
	75	680	540	445	1790	700	1200	
C2185-885 (8 POLES)	75	880	730	600	1930	900	1660	
	90	880	730	600	2260	900	2030	
	110	880	730	600	2260	900	2100	
C2905-710 (10 POLES)	132	980	730	600	2260	1000	2260	
	150	1180	1000	805	2280	1200	3810	
	160	1180	1000	805	2280	1200	3820	
	185	1180	1000	805	2480	1200	3960	
	200	1180	1000	805	2480	1200	4040	
	220	1180	1000	805	2480	1200	4050	
	250	1180	1000	805	2480	1200	4240	

Dimensions are Approximate

Note:

†1 Includes weight of 33 ft. standard length cables.





DSZ3

EBARA Submersible Propeller Pumps

Dimensions

Project: _____ Model: _____ Chk'd: _____ Date: _____

Apply to Model V0494, V0554, V0754

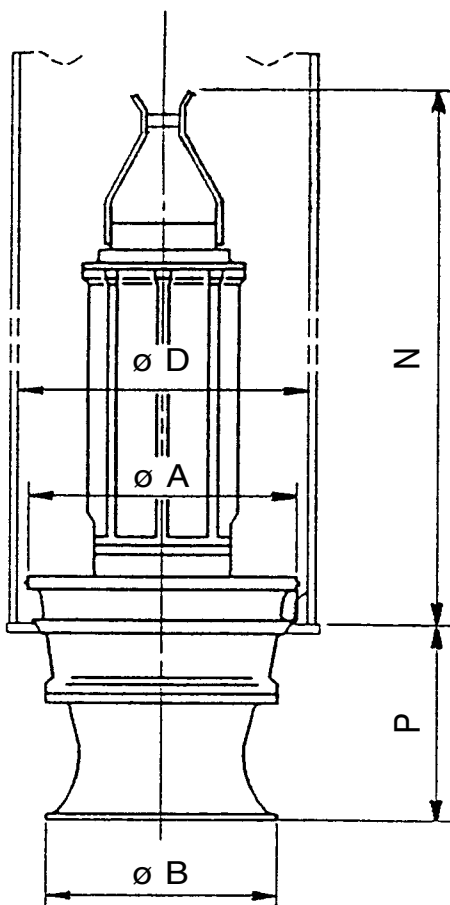

Dimensions: inch

Model (Pole)	HP	Pump & Motor					Column Pipe Dia. D (†2)	Weight Lbs (†1)
		A (†2)	B	P	N			
V0494-1170 (6 POLES)	25	Contact EBARA						
	30	Contact EBARA						
	40	26 ³ / ₄	18 ¹ / ₈	17 ¹¹ / ₁₆	55 ¹ / ₈	28	1675	
	50	26 ³ / ₄	18 ¹ / ₈	17 ¹¹ / ₁₆	55 ¹ / ₈	28	1720	
V0494-880 (8 POLES)	10	Contact EBARA						
	15	Contact EBARA						
	20	Contact EBARA						
V0554-1170 (6 POLES)	50	26 ³ / ₄	21 ¹ / ₄	15 ³ / ₈	58 ¹ / ₄	28	1808	
	60	26 ³ / ₄	21 ¹ / ₄	15 ³ / ₈	62 ³ / ₁₆	28	1874	
	75	26 ³ / ₄	21 ¹ / ₄	15 ³ / ₈	62 ³ / ₁₆	28	1874	
V0554-880 (8 POLES)	20	Contact EBARA						
	25	26 ³ / ₄	21 ¹ / ₄	15 ³ / ₈	58 ¹ / ₄	28	1764	
	30	26 ³ / ₄	21 ¹ / ₄	15 ³ / ₈	58 ¹ / ₄	28	1808	
	40	26 ³ / ₄	21 ¹ / ₄	15 ³ / ₈	62 ³ / ₁₆	28	1874	
V0754-885 (8 POLES)	100	34 ⁵ / ₈	27 ⁹ / ₁₆	20 ¹ / ₄	77 ⁹ / ₁₆	36	3307	
	120	40 ⁹ / ₁₆	27 ⁹ / ₁₆	24 ³ / ₁₆	86 ⁵ / ₈	42	4497	
	145	40 ⁹ / ₁₆	27 ⁹ / ₁₆	24 ³ / ₁₆	86 ⁵ / ₈	42	4630	
	175	40 ⁹ / ₁₆	27 ⁹ / ₁₆	24 ³ / ₁₆	86 ⁵ / ₈	42	4784	

Dimensions: mm

Model (Pole)	KW	Pump & Motor					Column Pipe Dia. D (†2)	Weight kgf (†1)
		A (†2)	B	P	N			
V0494-1170 (6 POLES)	18.5	Contact EBARA						
	22	Contact EBARA						
	30	680	460	450	1400	700	760	
	37	680	460	450	1400	700	780	
V0494-880 (8 POLES)	7.5	Contact EBARA						
	11	Contact EBARA						
	15	Contact EBARA						
V0554-1170 (6 POLES)	37	680	540	390	1480	700	820	
	45	680	540	390	1580	700	850	
	55	680	540	390	1580	700	850	
V0554-880 (8 POLES)	15	Contact EBARA						
	18.5	680	540	390	1480	700	800	
	22	680	540	390	1480	700	820	
	30	680	540	390	1580	700	850	
V0754-885 (8 POLES)	75	880	700	515	1970	900	1500	
	90	1030	700	615	2200	1050	2040	
	110	1030	700	615	2200	1050	2100	
	132	1030	700	615	2200	1050	2170	

Dimensions are Approximate

Note:

†1 Includes weight of 33 ft. standard length cables.

†2 Consult EBARA if smaller diameter is required.





DSZ3

EBARA Submersible Propeller Pumps

Dimensions

Project: _____ Model: _____ Chk'd: _____ Date: _____

Apply to Model V0754, V0854, V0974

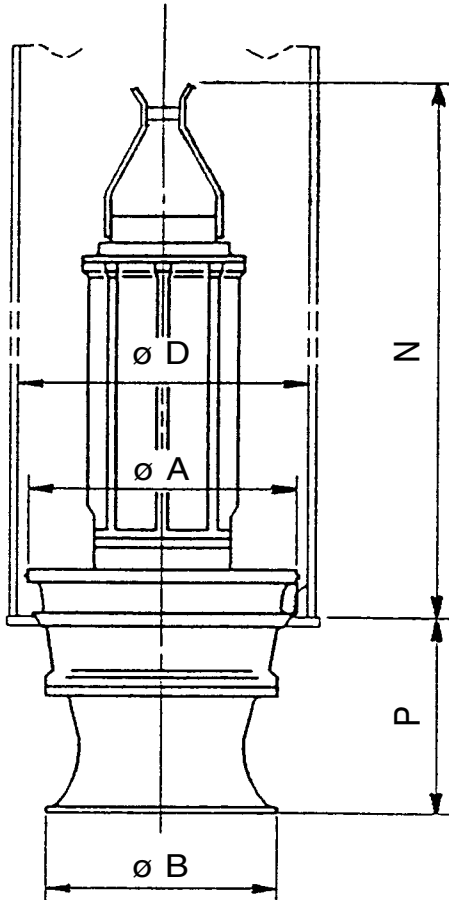

Dimensions: inch

Model (Pole)	HP	Pump & Motor					Column Pipe Dia. D (†2)	Weight Lbs (†1)
		A (†2)	B	P	N			
V0754-710 (10 POLES)	50	34 ⁵ / ₈	27 ⁹ / ₁₆	20 ¹ / ₄	71 ⁵ / ₈	36	3020	
	60	34 ⁵ / ₈	27 ⁹ / ₁₆	20 ¹ / ₄	77 ⁹ / ₁₆	36	3219	
	75	34 ⁵ / ₈	27 ⁹ / ₁₆	20 ¹ / ₄	77 ⁹ / ₁₆	36	3307	
	100	40 ⁹ / ₁₆	27 ⁹ / ₁₆	24 ³ / ₁₆	86 ⁵ / ₈	42	4608	
V0854-710 (10 POLES)	100	40 ³ / ₄	28 ³ / ₄	25 ⁹ / ₁₆	86 ¹ / ₄	42	4784	
	120	46 ⁷ / ₁₆	28 ³ / ₄	25 ⁹ / ₁₆	86 ¹ / ₄	48	5247	
	145	46 ⁷ / ₁₆	28 ³ / ₄	25 ⁹ / ₁₆	90 ³ / ₁₆	48	5556	
V0974-710 (10 POLES)	175	52 ³ / ₁₆	39 ³ / ₈	28 ¹⁵ / ₁₆	94 ¹ / ₈	54	7716	
	200	52 ³ / ₁₆	39 ³ / ₈	28 ¹⁵ / ₁₆	94 ¹ / ₈	54	7937	
	215	52 ³ / ₁₆	39 ³ / ₈	28 ¹⁵ / ₁₆	94 ¹ / ₈	54	7937	
	245	52 ³ / ₁₆	39 ³ / ₈	28 ¹⁵ / ₁₆	101 ¹⁵ / ₁₆	54	8245	
	265	52 ³ / ₁₆	39 ³ / ₈	28 ¹⁵ / ₁₆	101 ¹⁵ / ₁₆	54	8422	

Dimensions: mm

Model (Pole)	KW	PUMP & MOTOR					Column Pipe Dia. D (†2)	Weight kgf (†1)
		A (†2)	B	P	N			
V0754-710 (10 POLES)	37	880	700	515	1820	900	1370	
	45	880	700	515	1970	900	1460	
	55	880	700	515	1970	900	1500	
	75	1030	700	615	2200	1050	2090	
V0854-710 (10 POLES)	75	1030	730	650	2190	1050	2170	
	90	1180	730	650	2190	1200	2380	
	110	1180	730	650	2290	1200	2520	
V0974-710 (10 POLES)	132	1325	1000	735	2390	1350	3500	
	150	1325	1000	735	2390	1350	3600	
	160	1325	1000	735	2390	1350	3600	
	185	1325	1000	735	2590	1350	3740	
	200	1325	1000	735	2590	1350	3820	

Dimensions are Approximate

Note:

†1 Includes weight of 33 ft. standard length cables.

†2 Consult EBARA if smaller diameter is required.





DSZ3

EBARA Submersible Propeller Pumps

Dimensions

Project: _____ Model: _____ Chk'd: _____ Date: _____

Apply to Model V1154

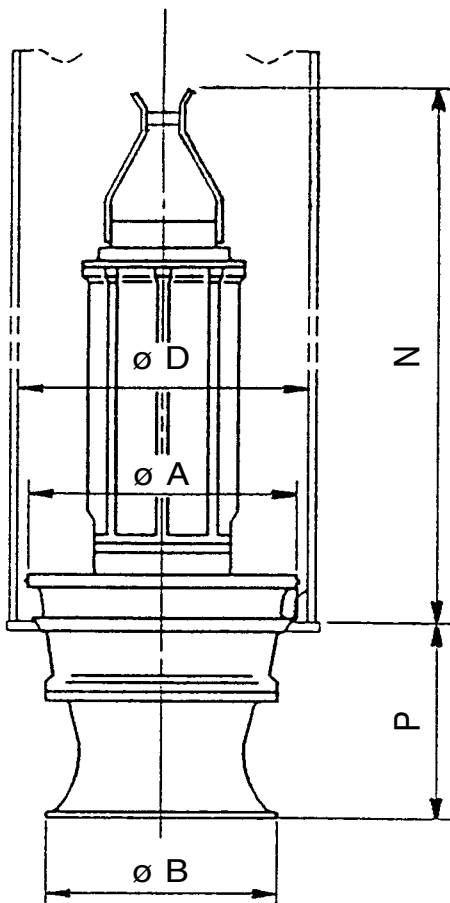

Dimensions: inch

Model (Pole)	HP	Pump & Motor					Column Pipe Dia. D	Weight Lbs (†1)
		A	B	P	N			
V1154-593 (12 POLES)	200	52 ³ / ₁₆	44 ¹ / ₂	31 ¹¹ / ₁₆	101 ¹⁵ / ₁₆	54	8730	
	215	52 ³ / ₁₆	44 ¹ / ₂	31 ¹¹ / ₁₆	101 ¹⁵ / ₁₆	54	8951	
	245	52 ³ / ₁₆	44 ¹ / ₂	31 ¹¹ / ₁₆	101 ¹⁵ / ₁₆	54	9149	
	265	58 ⁷ / ₁₆	44 ¹ / ₂	31 ¹¹ / ₁₆	101 ¹⁵ / ₁₆	60	9568	
	295	58 ⁷ / ₁₆	44 ¹ / ₂	31 ¹¹ / ₁₆	101 ¹⁵ / ₁₆	60	9568	
	335	Contact EBARA						
	375	Contact EBARA						
422	58 ⁷ / ₁₆	44 ¹ / ₂	31 ¹¹ / ₁₆	118	60	14300		

Dimensions: mm

Model (Pole)	KW	Pump & Motor					Column Pipe Dia. D	Weight kgf (†1)
		A	B	P	N			
V1154-593 (12 POLES)	150	1325	1130	805	2590	1350	3960	
	160	1325	1130	805	2590	1350	4060	
	185	1325	1130	805	2590	1350	4150	
	200	1475	1130	805	2590	1500	4340	
	220	1475	1130	805	2590	1500	4340	
	250	Contact EBARA						
	280	Contact EBARA						
315	1475	1130	805	3000	1500	6500		

Illinois Location:
 (847) 841-7867
 860 Church Rd Elgin, IL 60123

Minnesota Location:
 (651) 758-7867
 330 Mill Bay South Suite 1511
 Afton, MN 55001

PumpSupplyInc.com

Dimensions are Approximate

Note:

†1 Includes weight of 33 ft. standard length cables.





DSZ3

EBARA Submersible Propeller Pumps

Sectional View

Project: _____

Model: _____

Chk'd: _____

Date: _____

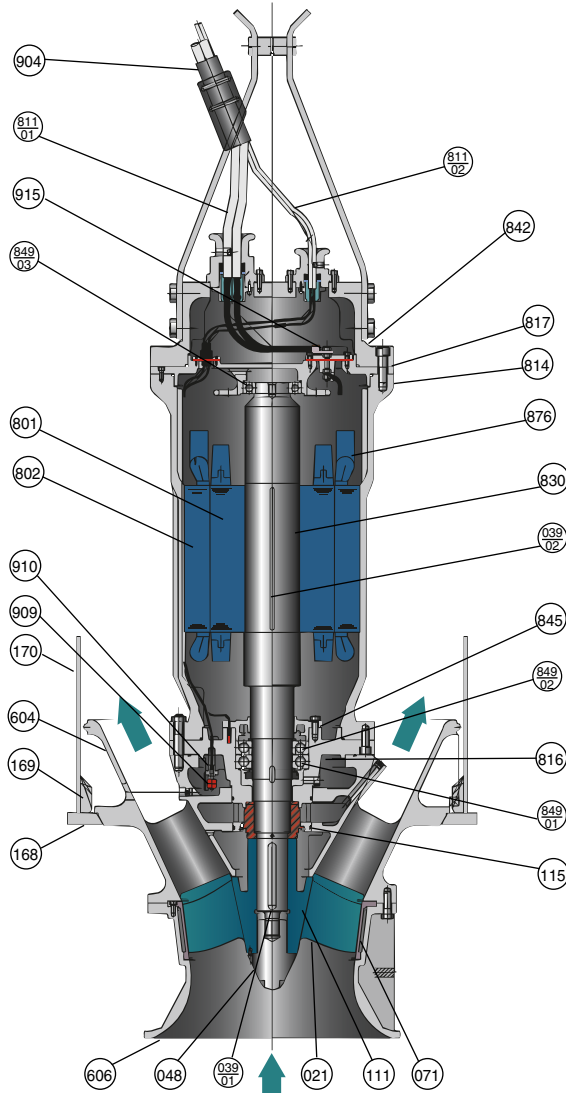

No.	Qty	Part Name	Material	ATM/AISI Code	No.	Qty	Part Name	Material	ATM/AISI Code
915	1	Terminal Board			811-01	1	Power Cable		
910	1	Leakage Detector Support	Cast Iron	ASTM A48 CL. 30	802	1	Stator	Copper	
909	1	Leakage Detector			801	1	Rotor	Aluminum	
904	1	Lifting Hanger	Steel	ASTM A283 GR.D	606	1	Suction Bell	Cast Iron	ASTM A48 CL. 35
876	1	Thermal Protector			604	1	Discharge Bowl	Cast Iron	ASTM A48 CL. 35
849-03	1	Ball Bearing	Steel		170	1	Column Pipe	Steel	ASTM A283 GR. D
849-02	1	Ball Bearing	Steel		169	1	Rotation Stopper	Steel	ASTM A283 GR. D
849-01	1	Ball Bearing	Steel		168	1	Sole Plate	Steel	ASTM A283 GR. D
845	1	Bearing Cover	Cast Iron	ASTM A48 CL. 30	115	1	O Ring	NBR	
842	1	Motor Cover	Cast Iron	ASTM A48 CL. 35	111	1	Mechanical Seal	See Detail	
830	1	Shaft	Stainless	AISI 403	071	1	Casing Liner	Stainless	ASTM A743-CF8
817	1	Opposite Side Bracket	Cast Iron	ASTM A48 CL. 35	048	1	Impeller Nut	Stainless	AISI 403
816	1	Power Side Bracket	Cast Iron	ASTM A48 CL. 35	039-02	1	Key	Steel	AISI 1050
814	1	Motor Frame	Cast Iron	ASTM A48 CL. 35	039-01	1	Key	Stainless	AISI 420
811-02	1	Control Cable			021	1	Impeller	Ductile Iron	ASTM A536-60-40

Optional Materials

021	1	Impeller	Stainless	ASTM A743 CF8
021	1	Impeller	Bronze	ASTM B584 C90300





DSZ3

EBARA Submersible Propeller Pumps

Accessories

Project: _____ Model: _____ Chk'd: _____ Date: _____

Sole Plate – (Standard Supply)

Ebara DSZ3 pump is installed on the sole plate with a rotation stopper.
 The sole plate is designed and manufactured by Ebara and is to be welded to the column pipe in accordance with the welding procedure prepared by Ebara.

Material: Rolled Steel, ASTM A283 Gr.D

Note:

Concentricity of D to B or C shall be as follows:

Max. concentricity

- 2.0mm for D=450–800mm
- 3.0mm for D=900–1350mm
- 4.0mm for D=1400–2000mm

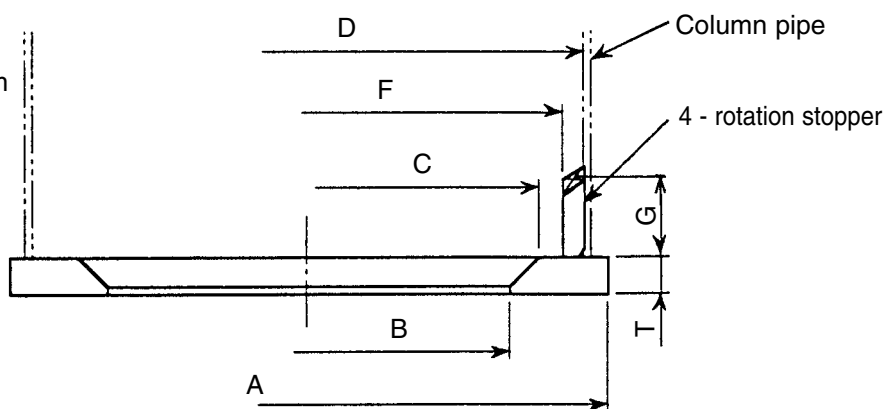

UNIT : INCH (mm)

Pipe Dia.	Min. Inside Dia. D	A	B	C	F	G	T	Lbs (kgf)
18 (450)	17 ⁵ / ₁₆ (440)	20 ¹ / ₁₆ (510)	14 ⁵ / ₁₆ (364)	15 ³ / ₁₆ (385)	15 ¹⁵ / ₁₆ (405)	2 ³ / ₁₆ (55)	7/8 (22)	37 (17)
20 (500)	19 ⁵ / ₁₆ (490)	22 ¹ / ₁₆ (560)	16 ⁵ / ₁₆ (414)	17 ⁷ / ₈ (435)	17 ¹⁵ / ₁₆ (455)	2 ³ / ₁₆ (55)	7/8 (22)	42 (19)
24 (600)	23 ¹ / ₄ (590)	26 (660)	20 ¹ / ₄ (514)	21 ¹ / ₁₆ (535)	21 ⁷ / ₈ (555)	2 ³ / ₈ (60)	7/8 (22)	51 (23)
28 (700)	27 ³ / ₁₆ (690)	29 ¹⁵ / ₁₆ (760)	23 ¹ / ₂ (597)	24 ⁵ / ₈ (625)	25 ⁷ / ₁₆ (646)	2 ³ / ₈ (60)	1 ¹ / ₈ (28)	84 (38)
30 (750)	29 ¹ / ₈ (740)	31 ⁷ / ₈ (810)	25 ¹ / ₂ (647)	26 ⁹ / ₁₆ (675)	27 ¹ / ₂ (698)	2 ⁹ / ₁₆ (65)	1 ¹ / ₈ (28)	90 (41)
32 (800)	31 ¹ / ₈ (790)	33 ⁷ / ₈ (860)	27 ¹ / ₁₆ (687)	28 ¹ / ₈ (715)	29 ¹ / ₁₆ (738)	2 ⁹ / ₁₆ (65)	1 ¹ / ₈ (28)	101 (46)
36 (900)	35 ¹ / ₁₆ (890)	37 ¹³ / ₁₆ (960)	31 (787)	32 ¹ / ₁₆ (815)	33 ¹ / ₁₆ (840)	2 ³ / ₄ (70)	1 ¹ / ₈ (28)	115 (52)
40 (1000)	39 (990)	42 ¹ / ₈ (1070)	34 ⁹ / ₁₆ (878)	35 ¹³ / ₁₆ (910)	36 ¹³ / ₁₆ (935)	2 ³ / ₄ (70)	1 ¹ / ₄ (32)	163 (74)
42 (1050)	40 ¹⁵ / ₁₆ (1040)	44 ¹ / ₈ (1120)	36 ⁹ / ₁₆ (928)	37 ¹³ / ₁₆ (960)	38 ³ / ₄ (985)	2 ³ / ₄ (70)	1 ¹ / ₄ (32)	172 (78)
48 (1200)	46 ⁷ / ₈ (1190)	50 (1270)	42 ¹ / ₁₆ (1068)	43 ⁵ / ₁₆ (1100)	44 ¹ / ₂ (1130)	3 ¹ / ₈ (80)	1 ¹ / ₄ (32)	207 (94)
54 (1350)	52 ³ / ₄ (1340)	56 ⁵ / ₁₆ (1430)	47 ⁷ / ₈ (1203)	48 ⁵ / ₈ (1235)	50 ⁹ / ₁₆ (1275)	3 ¹ / ₈ (80)	1 ¹ / ₄ (32)	262 (119)
56 (1400)	54 ³ / ₄ (1390)	58 ¹ / ₄ (1480)	49 ⁹ / ₁₆ (1253)	50 ⁹ / ₁₆ (1285)	52 ⁹ / ₁₆ (1325)	3 ¹ / ₈ (80)	1 ¹ / ₄ (32)	271 (123)
60 (1500)	58 ¹¹ / ₁₆ (1490)	62 ³ / ₁₆ (1580)	53 ¹ / ₄ (1353)	54 ¹ / ₂ (1385)	56 ¹ / ₈ (1425)	3 ¹ / ₈ (80)	1 ¹ / ₄ (32)	291 (132)
64 (1600)	62 ⁵ / ₈ (1590)	65 ³ / ₄ (1670)	57 ¹ / ₁₆ (1449)	58 ⁷ / ₁₆ (1485)	60 ¹ / ₁₆ (1525)	3 ¹ / ₈ (80)	1 ⁷ / ₁₆ (36)	373 (169)
72 (1800)	70 ¹ / ₂ (1790)	74 ¹ / ₁₆ (1890)	64 ¹⁵ / ₁₆ (1649)	66 ⁵ / ₁₆ (1685)	67 ¹⁵ / ₁₆ (1725)	3 ¹ / ₈ (80)	1 ⁷ / ₁₆ (36)	419 (190)
80 (2000)	78 ³ / ₈ (1990)	82 ⁵ / ₈ (2100)	72 ⁵ / ₈ (1844)	74 (1880)	75 ⁹ / ₁₆ (1920)	3 ¹ / ₈ (80)	1 ⁷ / ₁₆ (36)	496 (225)



3-236
rev. 01/02

EBARA Submersible Propeller Pumps

DSZ3

Accessories

Project: _____ Model: _____ Chk'd: _____ Date: _____

Sole Plate Welding Procedures

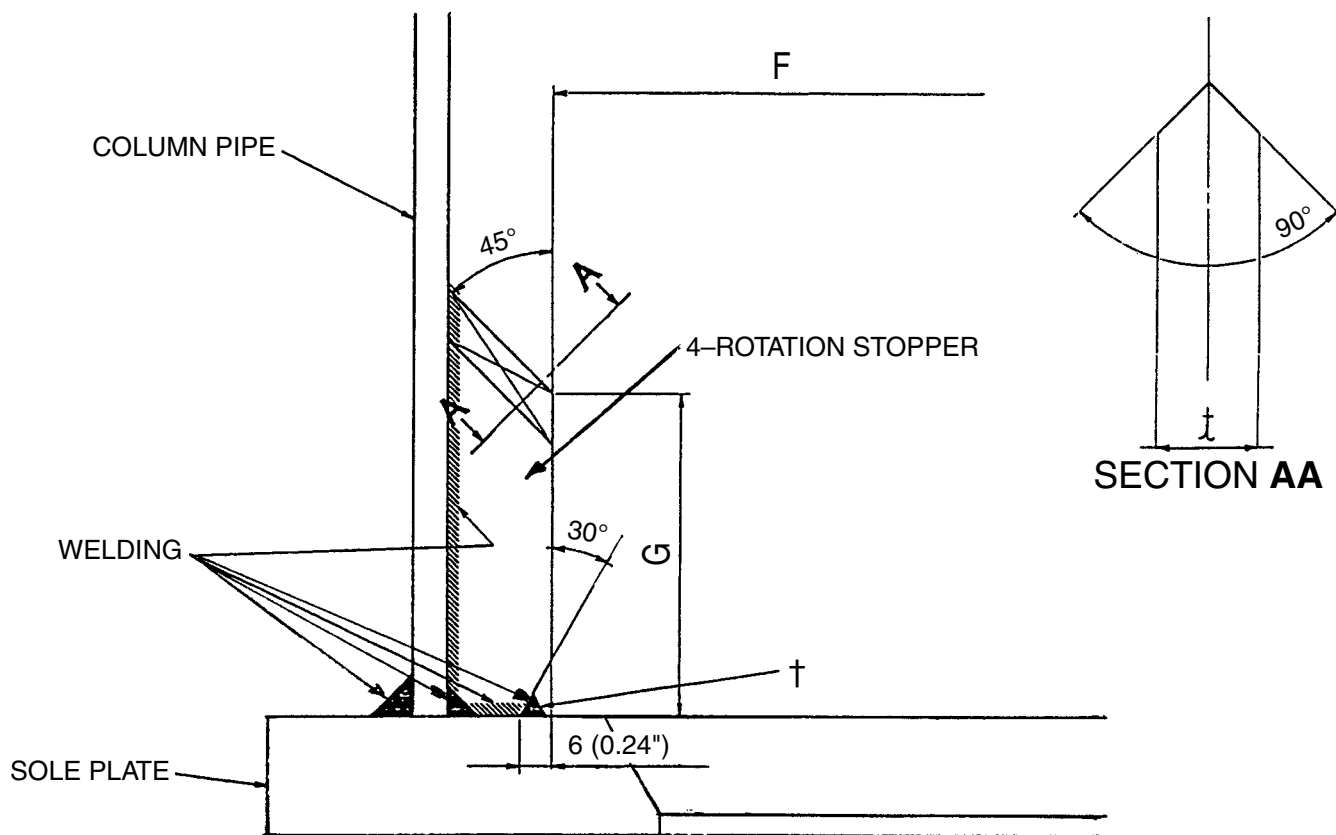

†: The welding bead is not to be projected from the inner surface of the rotation stopper.

Illinois Location:
 (847) 841-7867
 860 Church Rd Elgin, IL 60123

Minnesota Location:
 (651) 758-7867
 330 Mill Bay South Suite 1511
 Afton, MN 55001

PumpSupplyInc.com

