

**Illinois Location:**

(847) 841-7867

860 Church Rd Elgin, IL 60123

**Minnesota Location:**

(651) 758-7867

330 Mill Bay South Suite 1511 Afton, MN 55001

PumpSupplyInc.com



# PREMIUM MAGNETIC-DRIVE SEALLESS CENTRIFUGAL PUMPS DB, SP & MSDB SERIES

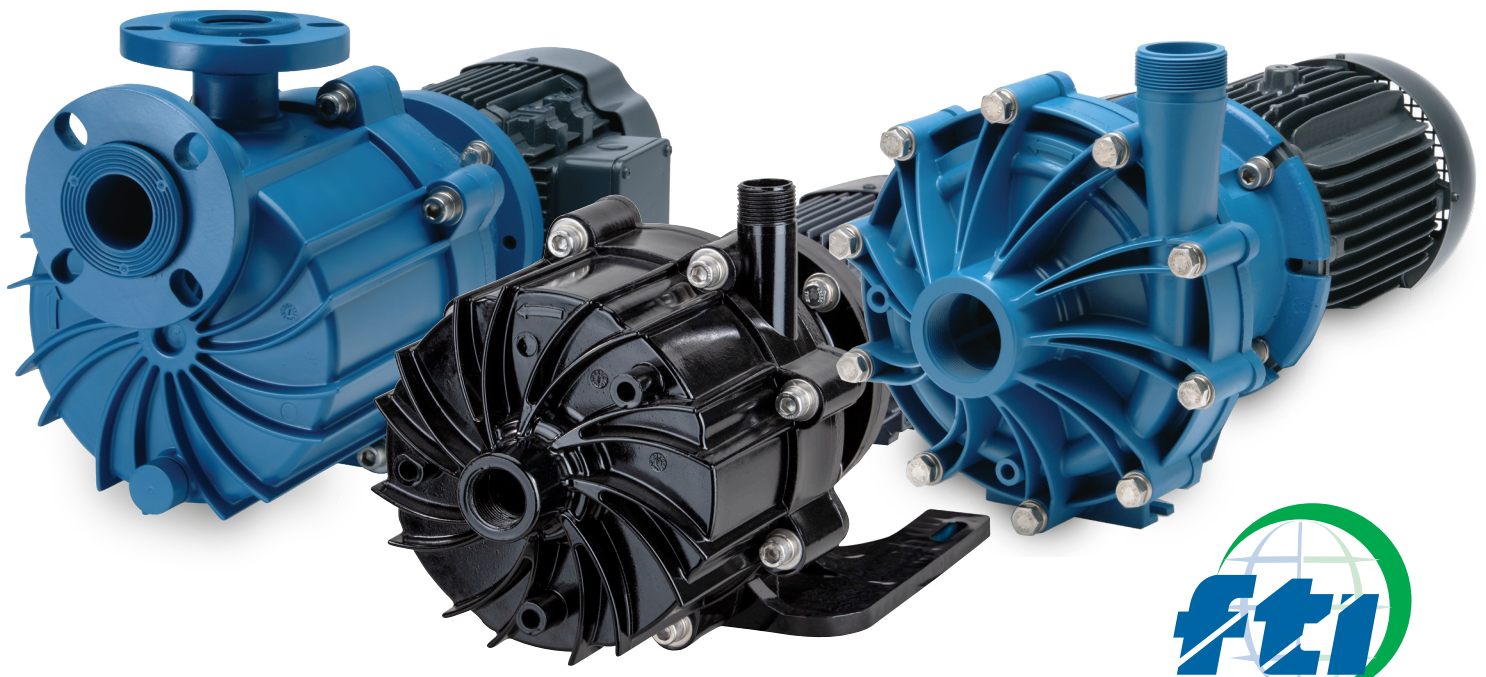
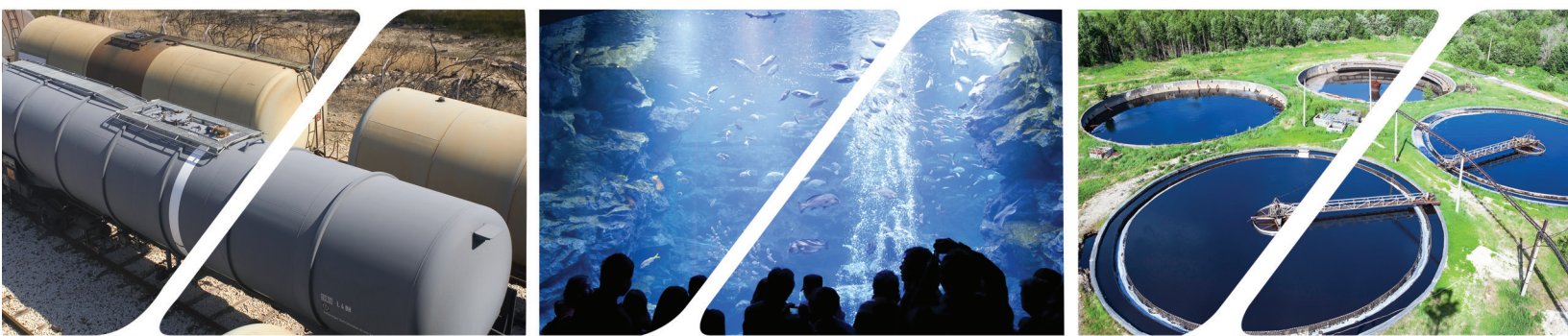

**FINISH THOMPSON INC.**

[finishthompson.com](http://finishthompson.com)

PUMPING SOLUTIONS **AROUND THE WORLD**

# DB SERIES | SP SERIES

MAGNETIC DRIVE, SEALLESS, CENTRIFUGAL PUMPS



FINISH THOMPSON INC.

BEST EFFICIENCY

BEST RUN DRY

BEST WARRANTY

STATE OF THE ART DESIGN



Backed by an industry **best** five-year warranty.

## DB SERIES FLOODED SUCTION

The Standard for Hydraulic Efficiency and Corrosive Fluid Handling

- **Engineered for performance** with state of the art software
- **Runs dry** for hours without damage when equipped with a carbon bushing.
- **Best efficiency** of any pump in its class
- Polypropylene or PVDF corrosion resistant construction
- Horizontal or vertical (with IEC motor only) installation
- High specific gravity handling – over 1.8



## SP SERIES SELF-PRIMING

The Most Innovative and Versatile Mag-Drive Centrifugal Pump

- **Big on power** - short on energy consumption
- **Deep-lift capabilities** (up to 25 feet/7.6 meters)
- **Lightning-fast priming**  
(18 feet/5.5 meters in 90 seconds)
- Ease of operation
- No seal replacement and no leaks
- Corrosion-resistant materials handle the most difficult applications





# DB SERIES | SP SERIES

## TECHNICAL SPECIFICATIONS



### DB & SP SERIES FEATURES

- Close-coupled design
- Polypropylene or PVDF construction
- Neodymium magnets on every model
- Replaceable shaft and bushing
- ISO 1940 G2.5 balancing
- Mounts to NEMA and IEC motor frames
- Easy Set measurement-free outer drive
- Mounts to motor without disassembly
- Back pullout design
- Five-year warranty
- CE certified
- ATEX available (DB only)

### DB & SP SERIES SPECIFICATIONS

- Up to 70% operating efficiency
- High working pressure up to 90 psi
- Maximum viscosity:  
DB - over 150 cP  
SP - over 50 cP
- Maximum temperature:  
Polypropylene - 180° F (82° C)  
PVDF - 220° F (104° C)

### SP SERIES SPECIFIC SPECIFICATIONS

- SP retains fluid for re-priming when shut off without a check valve
- SP lifts up to 25 feet (7.6 meters)\*\*
- SP primes up to 18 feet (5.5 meters) in 90 seconds\*\*\*.

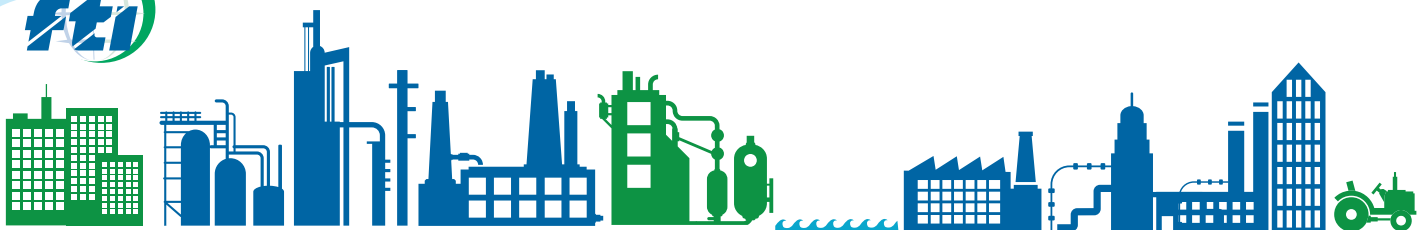

### DB & SP SERIES INDUSTRIES

- Chemical processes
- Metal plating/working
- Wastewater treatment
- Electronics manufacturing
- OEM equipment supply
- DI & High purity water
- Fume scrubbing
- Mining
- Paper mills
- Printing
- Pharmaceutical
- Chillers

### SP SERIES

- Sumps
- Underground storage tanks
- Rail cars and tanker trucks
- Over-the-wall applications
- Double containment tanks
- Piping systems that tend to have trapped or entrained air

**Note:** SP Series is not recommended for pumping flammable liquids.

**SP SERIES CAPABILITIES:** \* Specific gravity affects lift capability. Divide 25 feet (7.6 meters) by the specific gravity to determine maximum lift.

\*\* Lift determined on fresh, cold water. \*\*\* With maximum diameter impeller

# DB SERIES 3450/2900 rpm

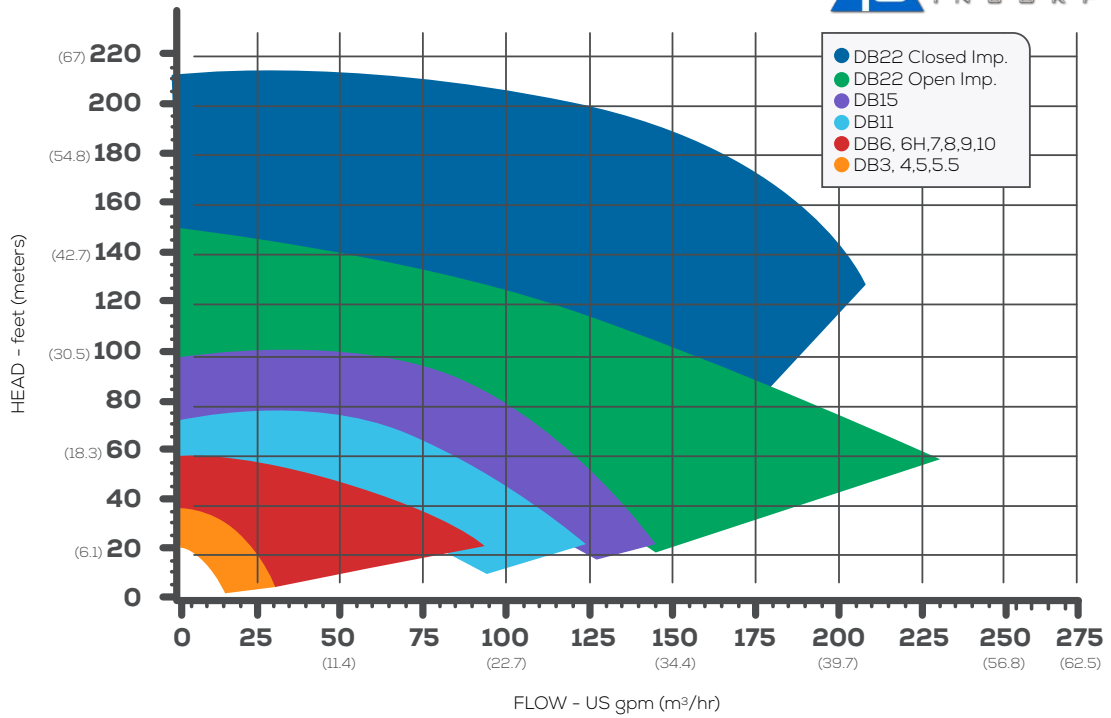

Note: Contact the factory or download the curve book for DB22 closed impeller performance at 2900 rpm.

The centrifugal selector program is designed to allow you to easily search Finish Thompson's collection of centrifugal pumps to find the products that most closely match your hydraulic and application criteria.



# SP SERIES 3450/2900 rpm

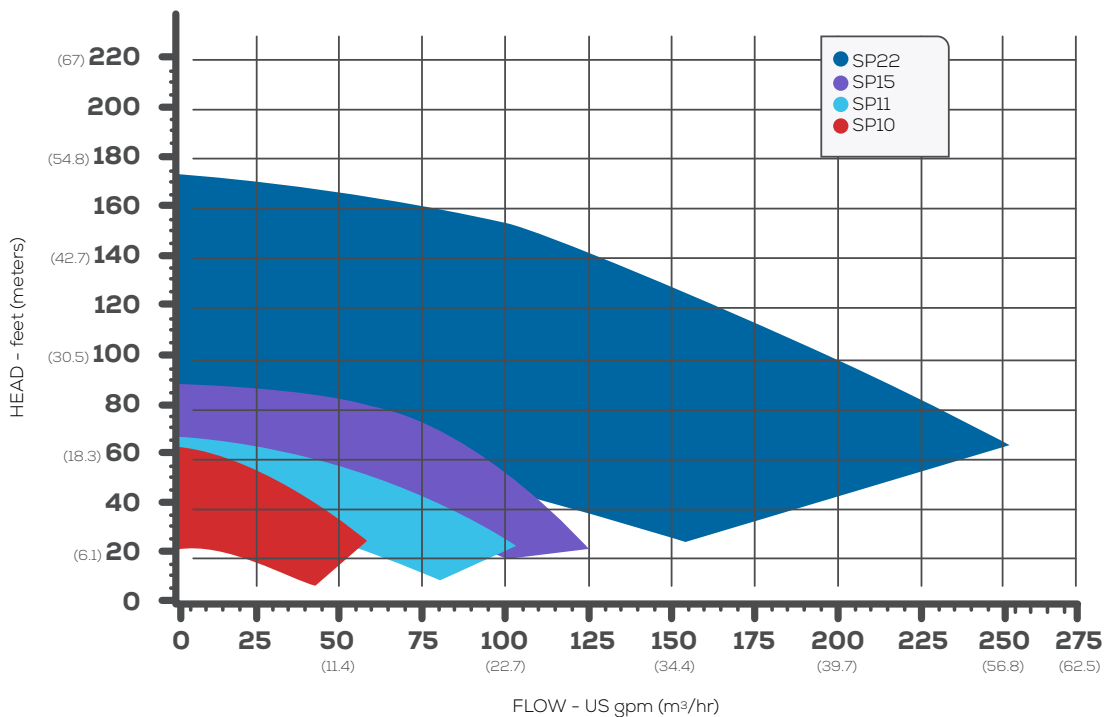

Note: SP curves based on flooded suction. Contact the factory or download the curve book for performance at various lifts.



# DB SERIES | SP SERIES

## MATERIALS OF CONSTRUCTION

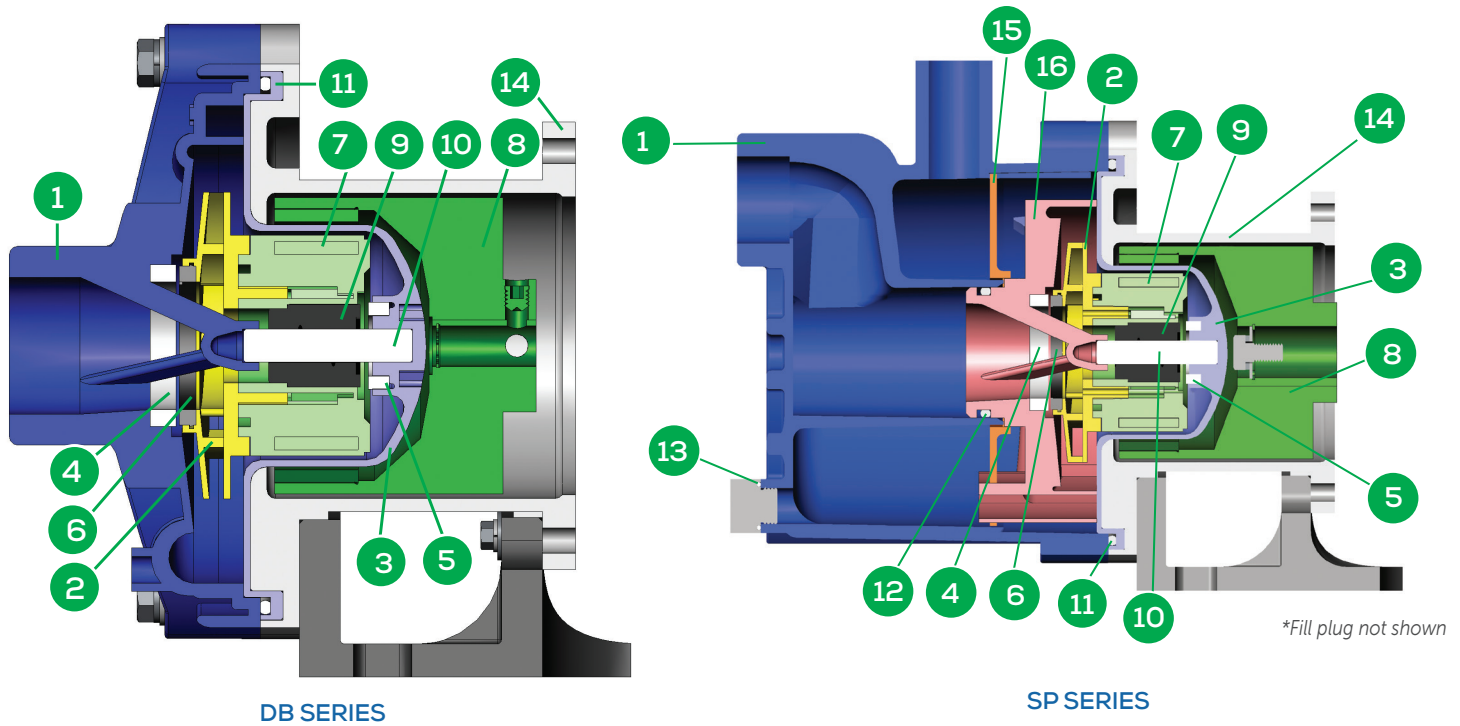

Note: The foot is offered only on the DB 11 & 15 and the SP 11 & 15 models

ITEM	DESCRIPTION	POLYPROPYLENE MODELS	PVDF MODELS
1, 2, 3, 15, 16	Housing, impeller, barrier, separator plate, inner volute	Glass fiber reinforced polypropylene	Carbon-fiber reinforced PVDF
4	Housing thrust ring, inner volute thrust ring	High-purity alumina ceramic, silicon carbide (SiC)	
5	Barrier thrust ring	High-purity alumina ceramic	
6	Impeller thrust ring	Molybdenum disulfide filled PTFE, silicon carbide (SiC)	
7	Inner drive magnet	Neodymium iron boron magnets encapsulated in unfilled polypropylene	Neodymium iron boron magnets encapsulated in unfilled PVDF
8	Outer drive magnet	Nickel-plated neodymium iron boron magnets / steel	
9	Bushing	Carbon, PTFE, high-purity alumina ceramic, silicon carbide (SiC)	
10	Shaft	High-purity alumina ceramic, Hastelloy C®, silicon carbide (SiC)	
11, 12, 13	O-ring	FKM, EPDM, Simriz® or Kalrez®	
14	Motor Adapter	Glass fiber reinforced polypropylene	

Kalrez® is a registered trademark of DuPont Performance Elastomers  
 Simriz® Perfluoroelastomer is a registered trademark of the Simrit® division of Freudenberg-NOK  
 Hastelloy® C is a registered trademark of Haynes International, Inc.

# DB SERIES | SP SERIES

## PREMIUM FEATURES

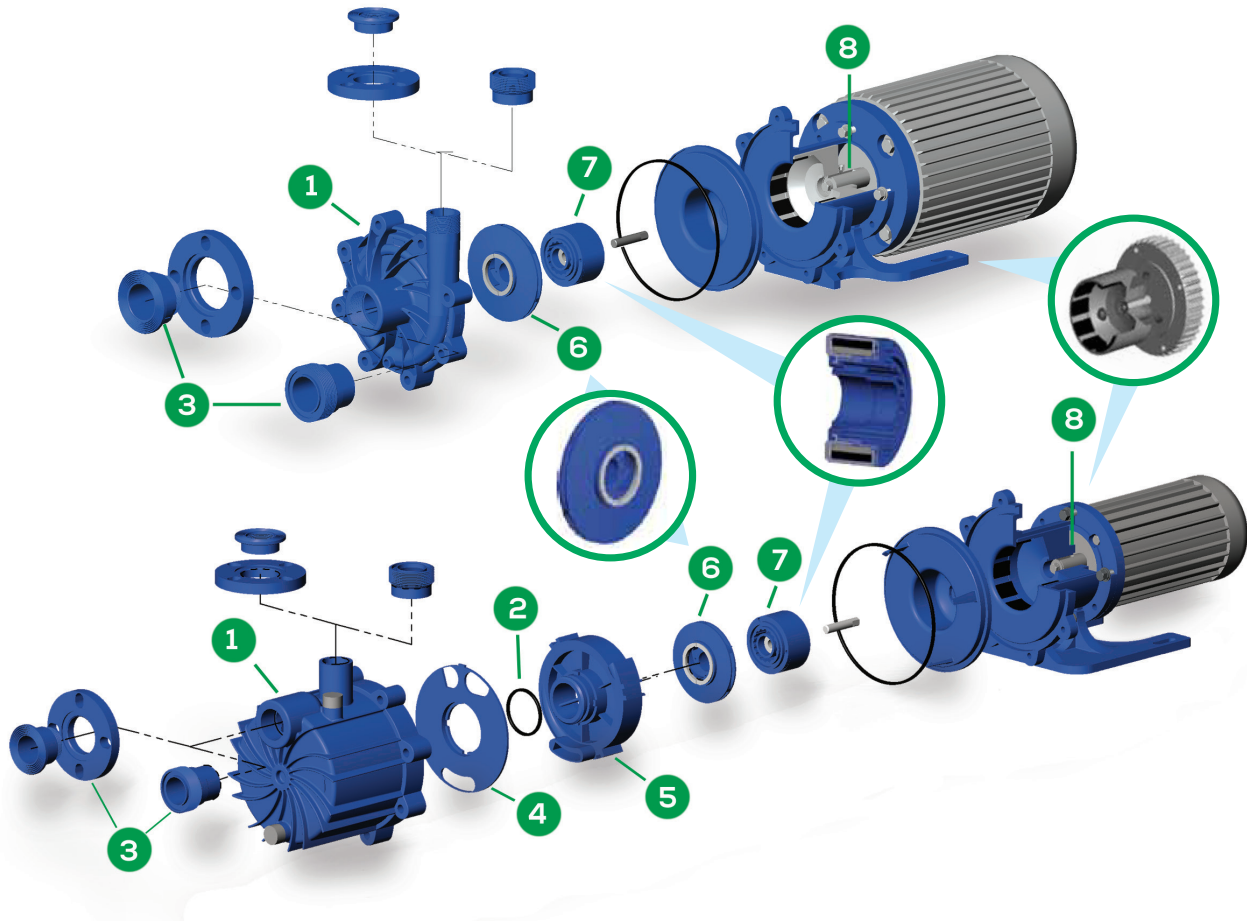

- 1 Thermoplastic Casing**  
Produces equivalent pump performance at both 60 Hz and 50 Hz operation. SP casing functions as a fluid reservoir featuring a molded-in "gooseneck" suction passage eliminating the need for internal check valves.
- 2 O-ring**  
On SP models, creates airtight seal between the inner volute and "gooseneck" suction passage. Helps maintain vacuum required for proper priming.
- 3 Multiple Connections**  
NPT or BSP threaded, raised-face adjustable flanges, or union connections.
- 4 Separator Plate - SP only**  
Allows liquid to flow to the impeller and discharge the air/liquid mixture created during priming back into the fluid reservoir.
- 5 Inner Volute - SP only**  
Allows air to be efficiently removed from the suction passages for fast priming.

- 6 Impeller**  
Two-piece impeller design allows impeller to be changed without having to replace inner drive.
- 7 Run Dry System/Magnet Technology**  
The DB and SP can run dry for hours without damage when equipped with a chemical grade carbon bushing.  
  
Neodymium magnets are the most powerful and efficient magnets available. Inner magnets are completely encapsulated in unfilled polypropylene or PVDF for superior magnet protection.
- 8 Easy Set Outer Drive**  
Measurement-free outer drive ensures optimum magnet alignment and easy motor installation.

## SP SERIES

### PRINCIPLES OF SELF-PRIMING

- 1 During pump installation, the priming housing is filled through the fill port.
- 2 As priming begins, air in the suction piping mixed with liquid in the priming chamber forms a vacuum in the inner volute. As they separate, the air rises out of the discharge piping while the liquid returns to the priming chamber.
- 3 The circulation process continues until liquid replaces all the air in the suction piping, beginning the pumping process.
- 4 When the pump is shut off, the priming chamber's gooseneck design ensures that enough liquid is retained for efficient re-priming.

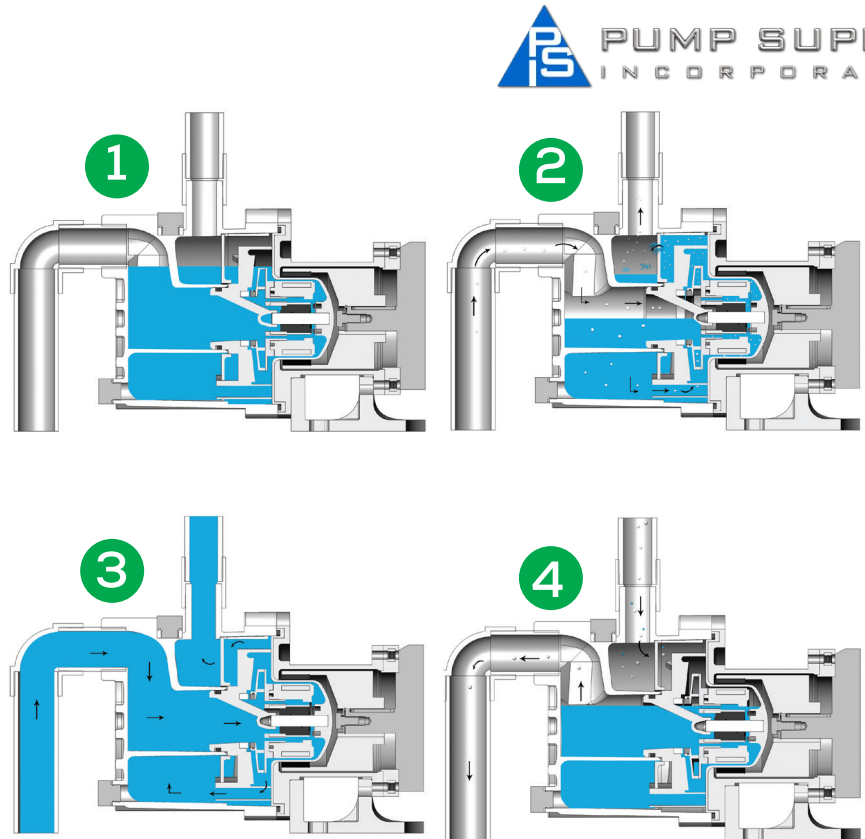

## SP SERIES APPLICATIONS

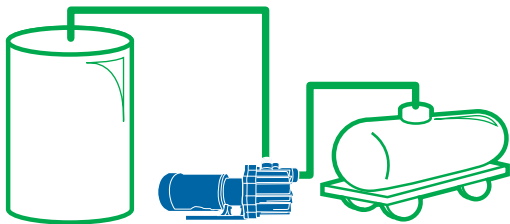

- 1 Transfer from top of rail cars or tanker trucks to bulk storage.

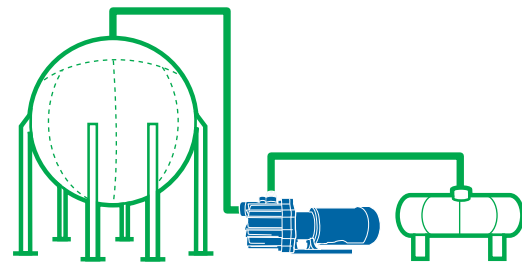

- 2 Transfer from bulk storage to process or day tanks.

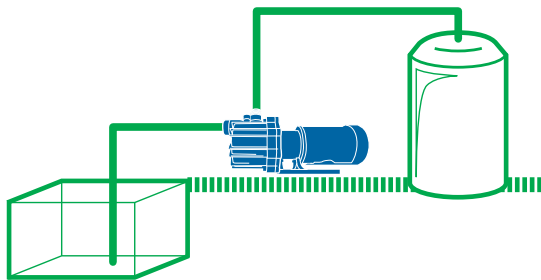

- 3 Pump from underground sumps or pits to double containment tanks.

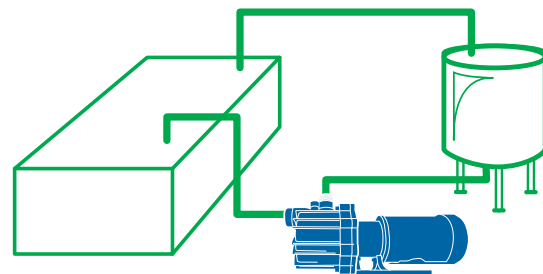

- 4 Pump from surface finishing tank through filters.



# MSDB SERIES

## MAGNETIC DRIVE, SEALLESS, CENTRIFUGAL PUMPS



### MSDB SERIES FLOODED SUCTION

#### Unique Magnetic Drive Multi-Stage Pumps

- Ideal for high head, low flow applications like spray, filtration and chemical delivery
- Based on proven DB11/15 platform, the MSDB shares many of the same features
- Each stage produces additional head allowing the MSDB to produce much higher heads at lower flows allowing the use of a smaller, less expensive pump

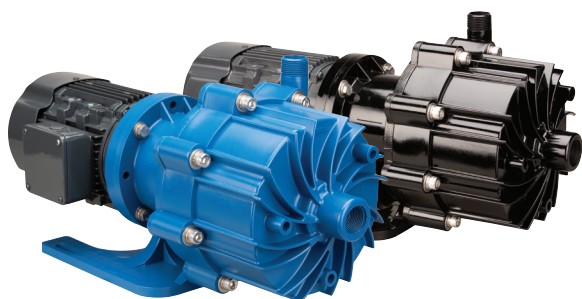

### MSDB SERIES FEATURES

- Heads up to 300 feet (91.5m)
- Minimum flow rate is 1 gpm (.23m<sup>3</sup>/h)
- Maximum working pressure up to 135 PSI (9.3 bar)
- High specific gravity handling – over 1.8
- Horizontal or vertical (with IEC motor only) installation
- Sealless design improves reliability with no seal maintenance to perform or seal leaks
- High power neodymium magnetic drive system handles high specific gravity fluids
- Two stage versions contain two impellers, three stage versions contain three impellers
- Engineered for corrosive fluids with polypropylene/PPS or PVDF/PPS construction
- Compact close-coupled design

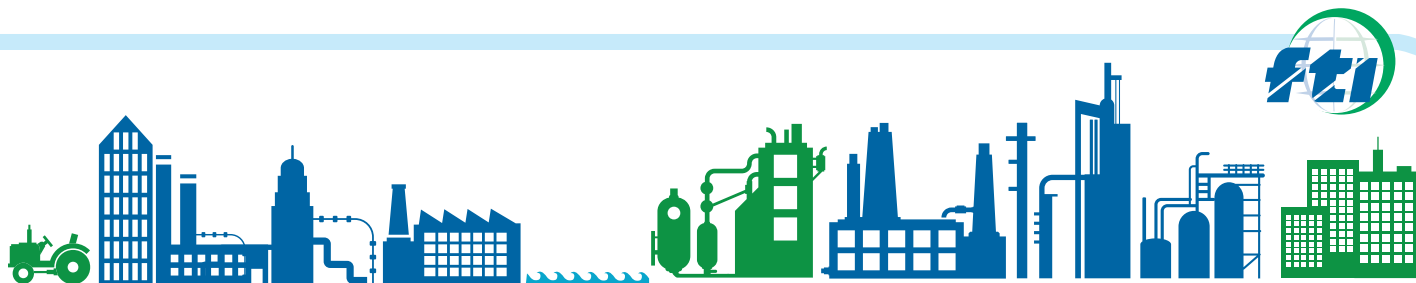

### MSDB SERIES SPECIFICATIONS

- Up to 47% operating efficiency
- High working pressure up to 135 psi/9.3 bar
- Maximum viscosity over 150 cP
- Maximum temperature:  
Polypropylene/PPS - 180° F (82° C)  
PVDF/PPS - 220° F (104° C)

### MSDB SERIES APPLICATIONS

- **Spray** - Electronics, plating, etching, scrubbers
- **Filtration** - Better filtration due to higher pressures
- **DEF/AdBlue** - Helps overcome frictional losses
- **Deionized / conditioned water systems** - Push feed water through resin and carbon tanks
- **Ultrafiltration systems** - Removes suspended particulate
- **Chemical delivery systems** - Higher pressures increase flow

# MSDB SERIES 3500 rpm

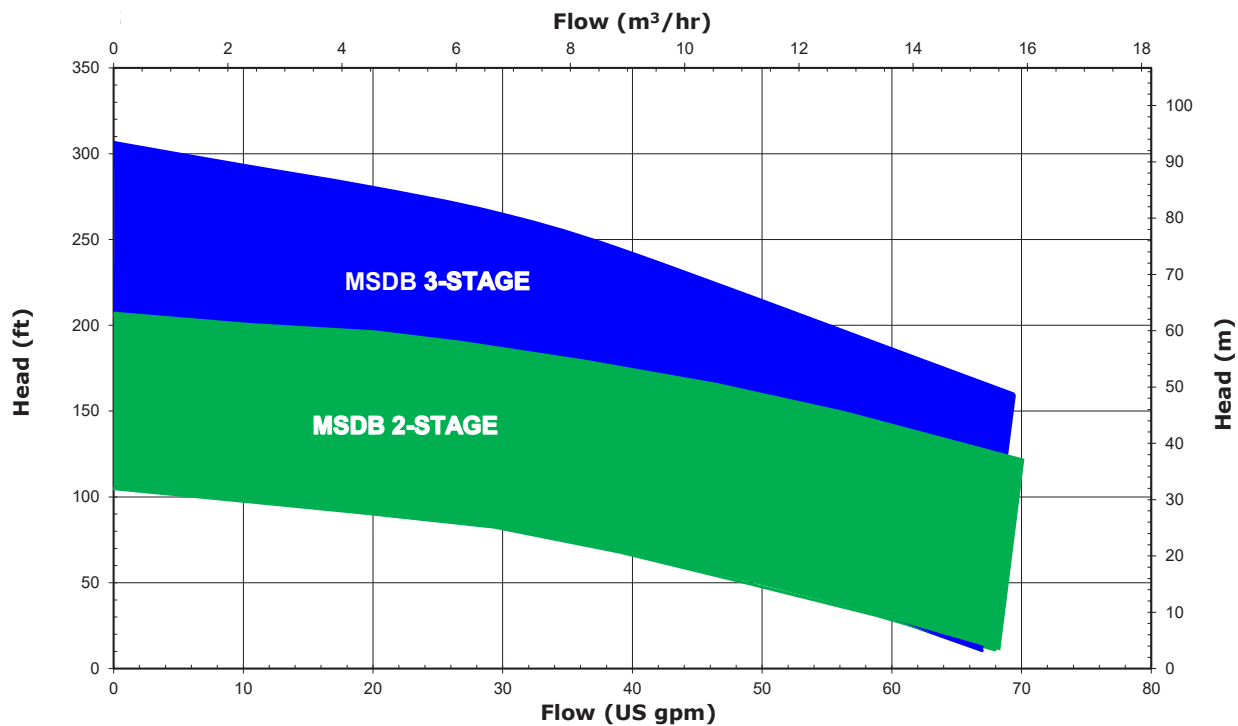

# MSDB SERIES 2900 rpm

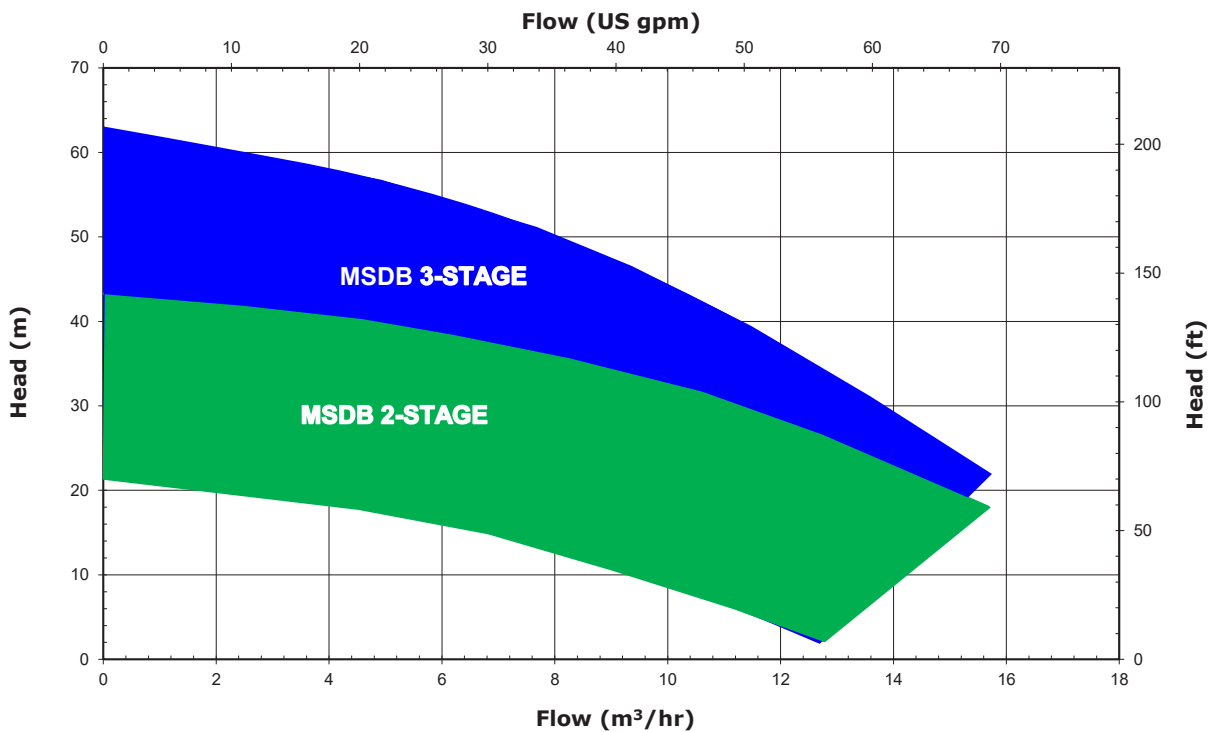

# MSDB SERIES

## MATERIALS OF CONSTRUCTION

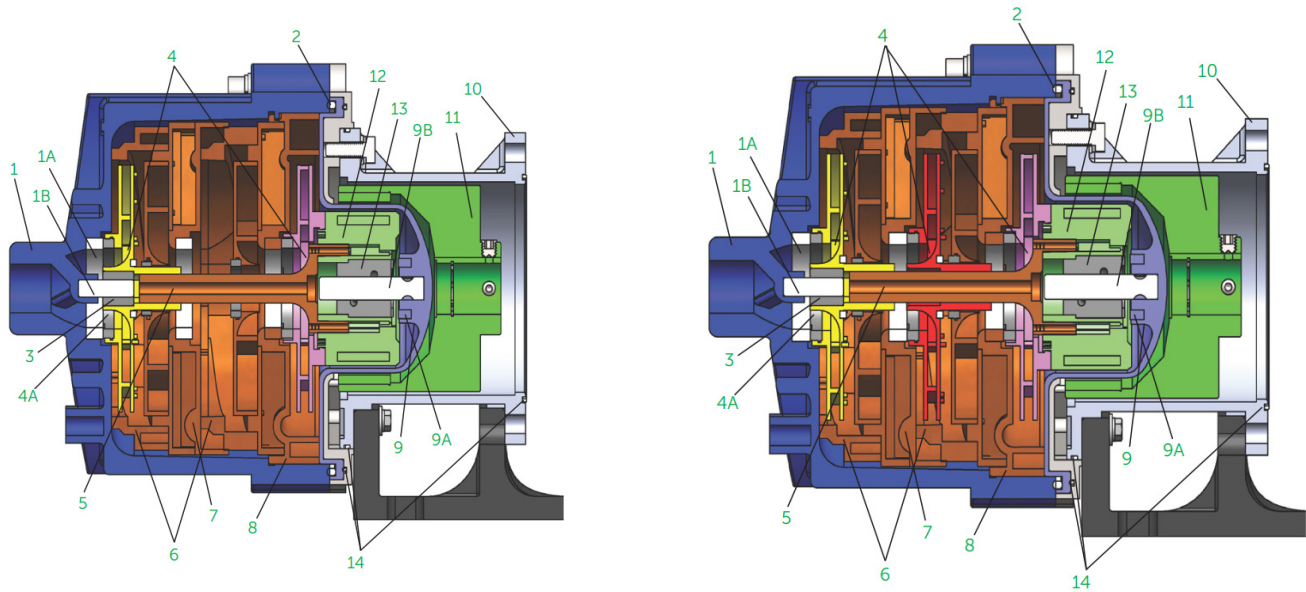

ITEM	DESCRIPTION	POLYPROPYLENE MODELS	PVDF MODELS
1	MSDB Housing	Glass fiber reinforced polypropylene (GF PP)	Carbon-fiber reinforced PVDF (CF PVDF)
1A	Housing Thrust Ring	High-purity alumina ceramic or silicon carbide (SiC)	
1B	Housing Shaft	High-purity alumina ceramic or silicon carbide (SiC)	
2	Housing O-ring	FFKM, EPDM, Simriz® or Kalrez®	
3	Impeller Bushing	Carbon, glass-filled PTFE, high-purity alumina ceramic or silicon carbide (SiC)	
4	Impellers	PPS	
4A	Impeller Thrust Ring	GF molybdenum disulfide filled PTFE or silicon carbide (SiC)	
5	Pump Shaft	PPS	
6	Diffuser	PPS	
7	Middle Housing	PPS	
8	Inner Volute	PPS	
9	Barrier	GF PP	CF PVDF
9A	Barrier Thrust Ring	High-purity alumina ceramic	
9B	Barrier Shaft	High-purity alumina ceramic or silicon carbide (SiC)	
10	Motor Adapter	GF PP	
11	Outer Drive Hub	Nickel-plated neodymium iron boron magnets/steel	
12	Impeller Drive	Epoxy-coated neodymium iron boron magnets encapsulated in:	
		Unfilled polypropylene	Unfilled PVDF
13	Impeller Drive Bushing	Carbon, glass-filled PTFE, high-purity alumina ceramic or silicon carbide (SiC)	
14	Vapor Protection O-rings	Buna N	

Kalrez® is a registered trademark of DuPont Performance Elastomers  
 Simriz® Perfluoroelastomer is a registered trademark of the Simrit® division of Freudenberg



# MSDB SERIES

## PREMIUM FEATURES

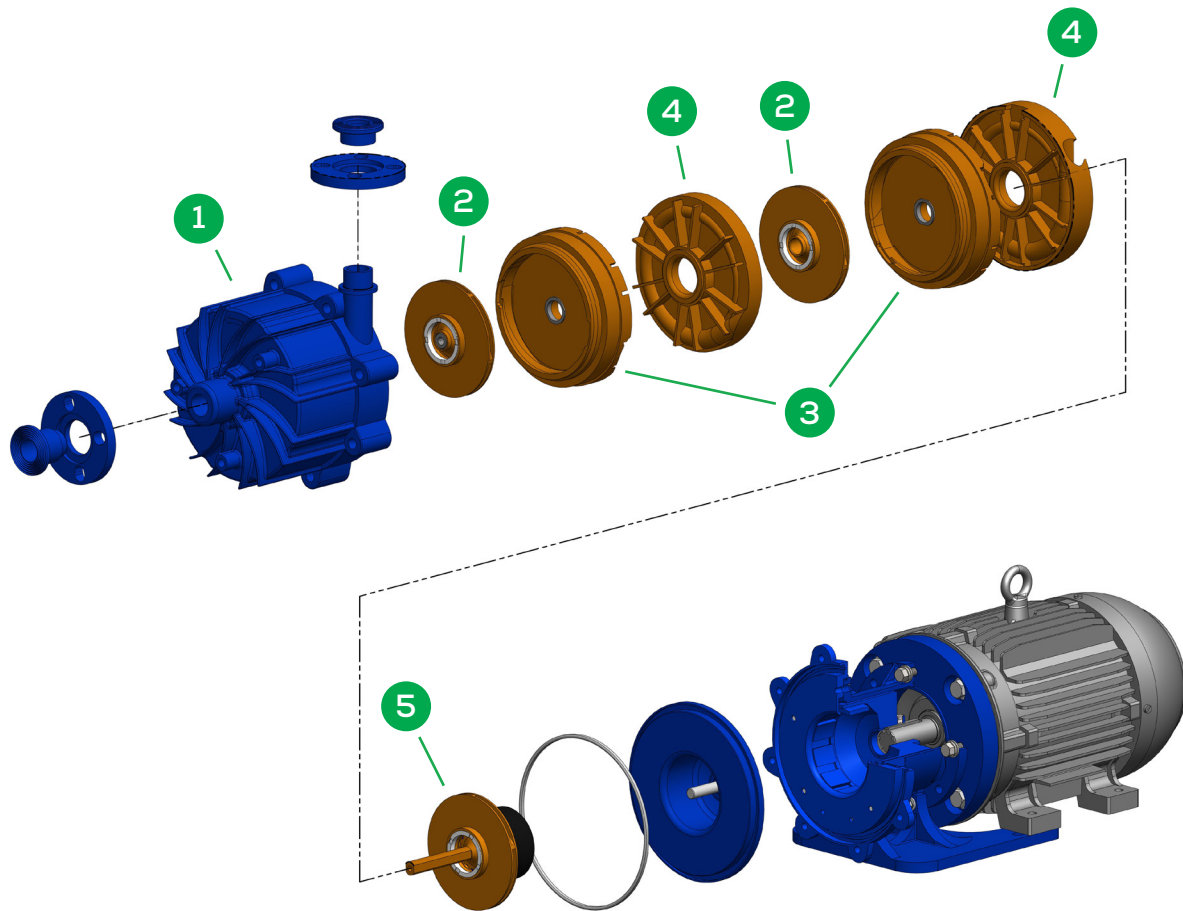

**1 Thermoplastic Casing / Connections**  
Allows for either 2 or 3 stage impeller options. NPT or BSP threaded or raised-face adjustable flanges.

**2 Impeller**  
High strength PPS impellers are available in 6 different trim sizes and provides excellent flow & head capabilities.

**3 Diffusers**  
Reduces velocity and guides liquid into the eye of the next impeller.

**4 Middle Housing & Inner Volute**  
Provide the 2nd & 3rd stage with the proper clearances to produce the extra flow & pressure provided by the MSDB pumps.

**5 Drive Shaft / Impeller Assembly**  
Engages the other impellers and provides the centrifugal force to power the MSDB.

*Note: All other components are the same as the DB & SP models mentioned previously in this brochure.*

# OTHER GREAT PRODUCTS FROM FINISH THOMPSON



**UC SERIES**  
ANSI DIMENSIONAL  
MAGNETIC DRIVE PUMPS



**DRUM/BARREL**  
PORTABLE FLUID  
TRANSFER SOLUTIONS



**AP SERIES**  
SEALED STAINLESS  
STEEL CENTRIFUGAL  
PUMPS



**GP SERIES**  
SEALED PLASTIC  
CENTRIFUGAL PUMPS



**VKC SERIES**  
VERTICAL MAGNETIC  
DRIVE SEALLESS  
CENTRIFUGAL PUMPS



**MSKC SERIES**  
MULTI-STAGE MAGNETIC  
DRIVE SEALLESS  
CENTRIFUGAL PUMPS



ONLINE PUMP SELECTOR PROGRAM IS DESIGNED TO ALLOW YOU TO EASILY SEARCH FINISH THOMPSON'S COLLECTION OF CENTRIFUGAL AND DRUM PUMPS TO FIND THE PRODUCTS THAT MEET APPLICATION CRITERIA.

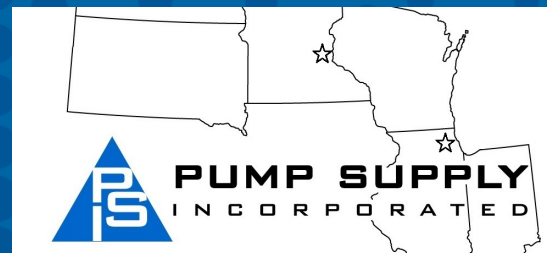

**Illinois Location:**

(847) 841-7867

860 Church Rd Elgin, IL 60123

**Minnesota Location:**

(651) 758-7867

330 Mill Bay South Suite 1511 Afton, MN 55001

PumpSupplyInc.com



finishthompson.com