

Stainless Steel Centrifugal Pump



Model 3U



Technical Specification

Illinois Location:

(847) 841-7867
860 Church Rd Elgin, IL 60120

Minnesota Location:

(651) 758-7867
330 Mill Bay South Suite 100
Afton, MN 55001

PumpSupplyInc.com



EBARA Pumps Americas Corporation

EBARA Stainless Steel Centrifugal Pumps

Model 3U

Contents

Item No.	Specifications	Selection Chart	Performance Curve	Pump Dimensions	Sectional View													
3U-32-125-3 HP	402	403	404	434	440													
3U-32-160A-5 HP			404															
3U-32-160B-5 HP						405												
3U-32-200- 7½ HP							406											
3U-32-200-1-10 HP								407										
3U-40-125A-5 HP									408									
3U-40-125B-5 HP										409								
3U-40-160-7½ HP											410							
3U-40-160-1-10 HP												411						
3U-40-200A-15 HP													412					
3U-40-200B-15 HP														413				
3U-50-125-7½ HP															414			
3U-50-125-1-10 HP																415		
3U-50-160-10 HP																	416	
3U-50-160-1-15 HP	417																	
3U-65-125-7½ HP		418	438															
3U-65-125-10 HP				419														
3U-65-125-15 HP					420													
3U-65-125-20 HP						421												
3U-65-160-10 HP							422											
3U-65-160-15 HP								423										
3U-65-160-20 HP									424									
3U-65-160-25 HP										425								
3U-65-200-20 HP											426							
3U-65-200-25 HP												427						
3U-65-200-30 HP													428					
3U-32-200-1 HP														402	423	429		436
3U4-32-200-1-1½ HP																	430	
3U4-32-200-2-2 HP	431																	
3U4-40-160-1 HP		432																
3U4-40-160-1-1½ HP			433															
3U4-40-200A-1½ HP				434														
3U4-40-200B-2 HP					435													
3U4 50-125-1 HP						436												
3U4 50-125-1-1½ HP							437											
3U4-50-125-2-2HP								438										
3U4-50-160-1½ HP									439									
3U4-50-160-1-2 HP										440								



EBARA Stainless Steel Centrifugal Pumps

Model 3U

Model Designation

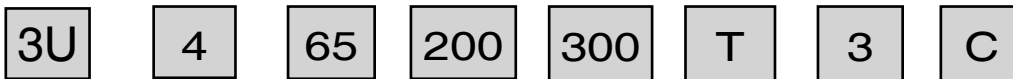

MODEL TYPE

3U- stainless steel centrifugal

SPEED

(none) – 3450 RPM
4 – 1725 RPM

DISCHARGE SIZE

32 – 1¼”
40 – 1½”
50 – 2”
65 – 2½”

IMPELLER PERFORMANCE CODE

125	1251	1252
160	1601	1601
200	2001	2002

MOTOR HP

10 – 1 HP	100 – 10HP
15 – 1.5 HP	150 – 15HP
20 – 2HP	200 – 20HP
30 – 3HP	250 – 25HP
50 – 5HP	300 – 30HP
75 – 7.5HP	

MOTOR ENCLOSURE

T – TEFC	W – Washdown
D – ODP	X – Explosion Proof

PHASE

1 – single phase
3 – three phase

MECHANICAL SEAL TYPE

C – Carbon/Ceramic/Viton
G – Carbon/Ceramic/Buna
H – Hot Water – Carbon/Ni-Resist/Viton
CO – Carbon-Ceramic-Viton
GO – Carbon-Ceramic-Buna
HO – Carbon-Ni-Resist-Viton

EPDM – Carbon-Ceramic-EPDM
SCCV – Si-Carbide-Carbon-Viton
VSC – Si-Carbide-Si-Carbide-Viton
ESC – Si-Carbide-Si-Carbide-EPDM



Certified to
NSF/ANSI/CAN 61
& 372

Note: Model 3U with seal code “C” is Certified



EBARA Stainless Steel Centrifugal Pumps**Model 3U****Specifications**

	Standard	Optional
Size		
Suction (150 lb ANSI R.F. equivalent)	3U32 – 2" ANSI Equivalent 3U40 – 2½" ANSI Equivalent 3U50 – 2½" ANSI Equivalent 3U65 – 3" ANSI Equivalent	Companion Flange Kit 150 Lb ANSI, Female NPT
Discharge (150 lb ANSI R.F. equivalent)	3U32 – 1¼ ANSI Equivalent 3U40 – 1½ ANSI Equivalent 3U50 – 2" ANSI Equivalent 3U65 – 2½" ANSI Equivalent	
Range of HP	3U – 1HP to 30 HP	
Range of Performance		
Capacity	5 to 633 GPM at 3450 RPM	
Head	9 to 282 Feet at 3450 RPM	
Liquid Handled		
Type of liquid	Clean water	Min -4°F (-20°C) with Carbon/Ceramic/EPDM seal
Temperature	14°F to 212°F (-10°C to 100°C)	Max 250°F (121°C) with Carbon/Ni-Resist/Viton seal
Max working pressure	145 PSI (10 Bar)	
Materials		
Casing	3U 304L Stainless Steel	3U65 304L Stainless Steel
Impeller (closed type)	304L Stainless Steel	316 Stainless Steel
Shaft Sleeve/Coupling	304L Stainless Steel	304L Stainless Steel
Bracket	Cast Iron	Cast Iron
Shaft Seal		
Seal Material	Mechanical Seal – Type 21 Carbon/Ceramic/Viton	Carbon/Ceramic/Buna Carbon/Ceramic/EPDM Carbon/Ni-Resist/Viton Si-Carbide-Si-Carbide- EPDM Si-Carbide/Carbon/Viton Si-Carbide/Si-Carbide/Viton
Direction of Rotation	Clockwise when viewed from motor end	
Motor		
Type	NEMA JM, TC, TSC Frame	
Speed	60Hz, 3450 RPM (2 poles) / 1750 RPM (4 poles)	
Bearing	Ball Bearing	
Single Phase	TEFC – 3 HP (230V) ODP – 3 HP to 10 HP (230 V)	
Three Phase	TEFC – 3 HP to 30 HP ODP – 3 HP to 30 HP 230/460 V (usable at 208V)	Explosion proof- consult factory for availability Washdown duty-consult factory for availability
Motor Protection	Overload protection must be provided	
Standard Accessories	Suction and Discharge Flange Gasket Motor Support	



EBARA Stainless Steel Centrifugal Pumps

Model 3U

Selection Chart

Nominal Speed 3450 RPM

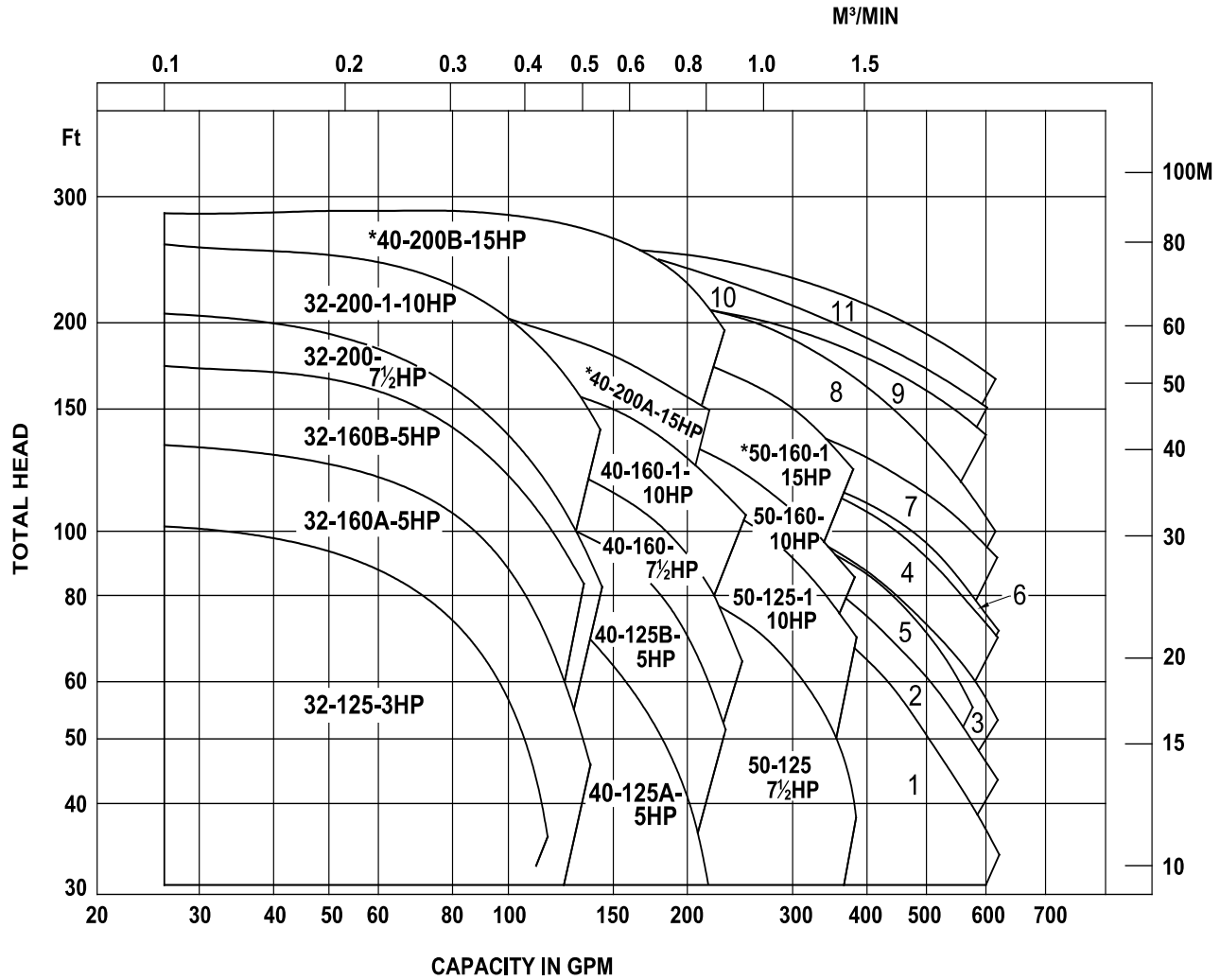

- | | |
|-------------------|-------------------|
| 1. 3U65-125-7.5HP | 7. 3U65-160-20HP |
| 2. 3U65-125-10HP | 8. 3U65-160-25HP |
| 3. 3U65-125-15HP | 9. 3U65-200-20HP |
| 4. 3U65-125-20HP | 10. 3U65-200-25HP |
| 5. 3U65-160-10HP | 11. 3U65-200-30HP |
| 6. 3U65-160-15HP | |

***Three phase motor only**

Illinois Location:
 (847) 841-7867
 860 Church Rd Elgin, IL 60120

Minnesota Location:
 (651) 758-7867
 330 Mill Bay South Suite :
 Afton, MN 55001

PumpSupplyInc.com

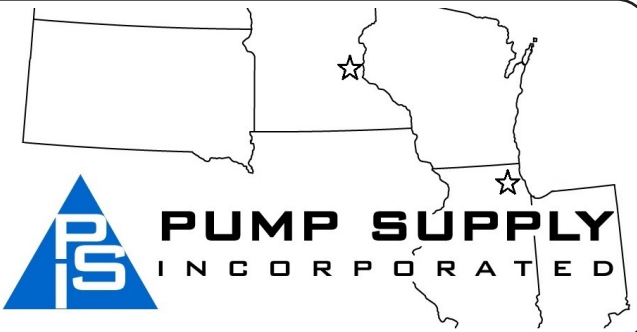

EBARA Stainless Steel Centrifugal Pumps

Model 3U

Performance Curves

3U 32-125-3HP

Nominal Speed: 3450 RPM

Size: 1 1/4 x 2 x 5 5/16

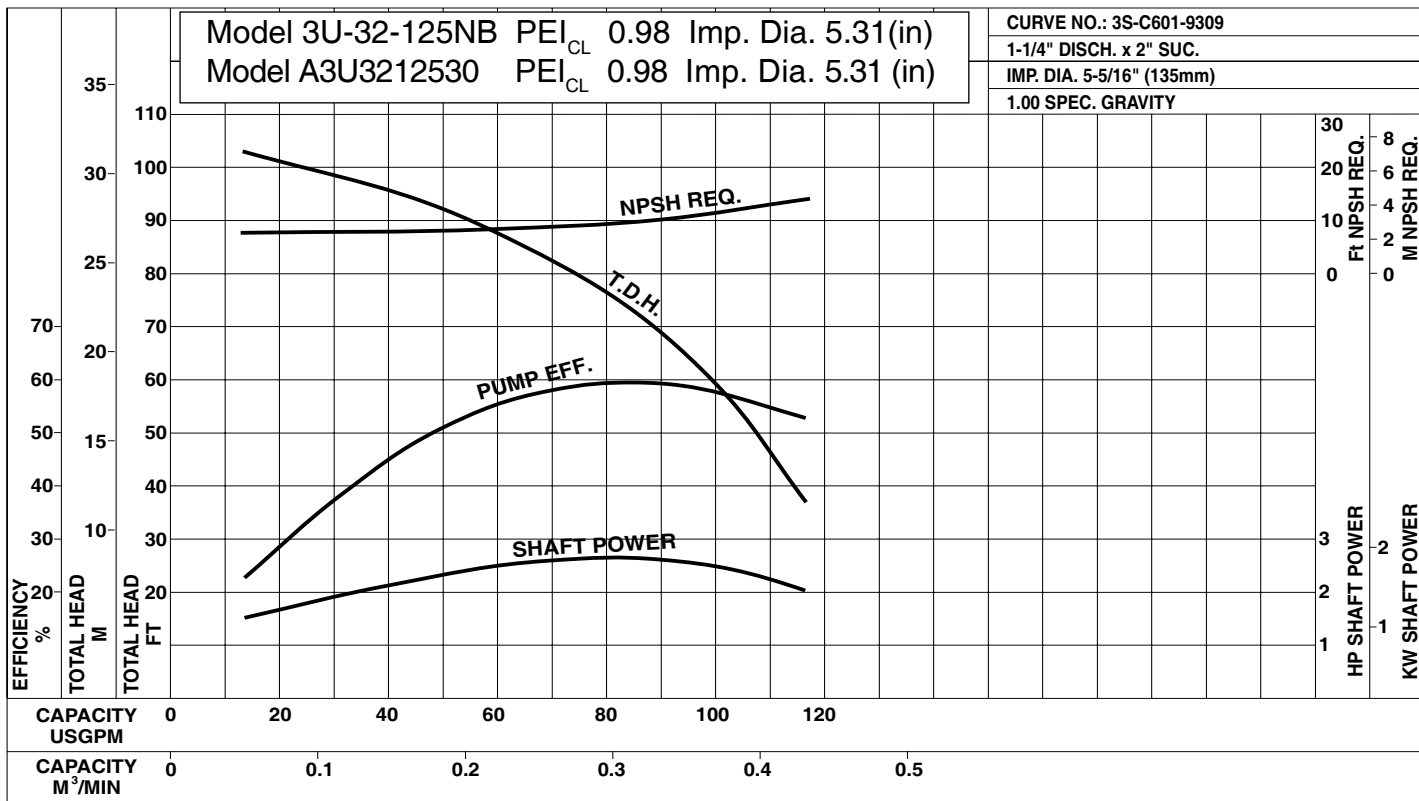

3U 32-160A-5HP

Nominal Speed: 3450 RPM

Size: 1 1/4 x 2 x 5 15/16

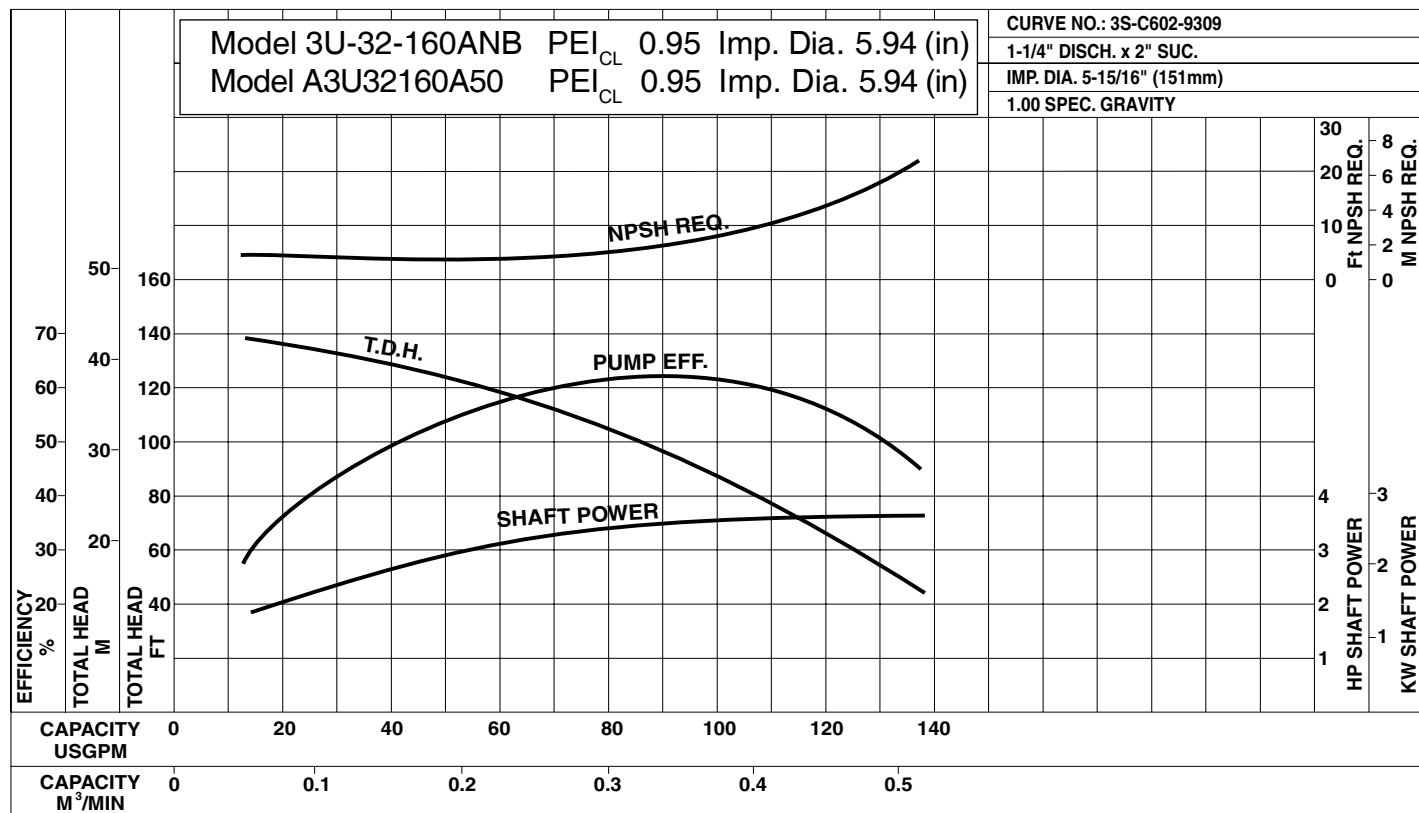

EBARA Stainless Steel Centrifugal Pumps

Model 3U

Performance Curves

3U 32-160B-5HP

Nominal Speed: 3450 RPM

Size: 1¼ x 2 x 6⁹/₁₆

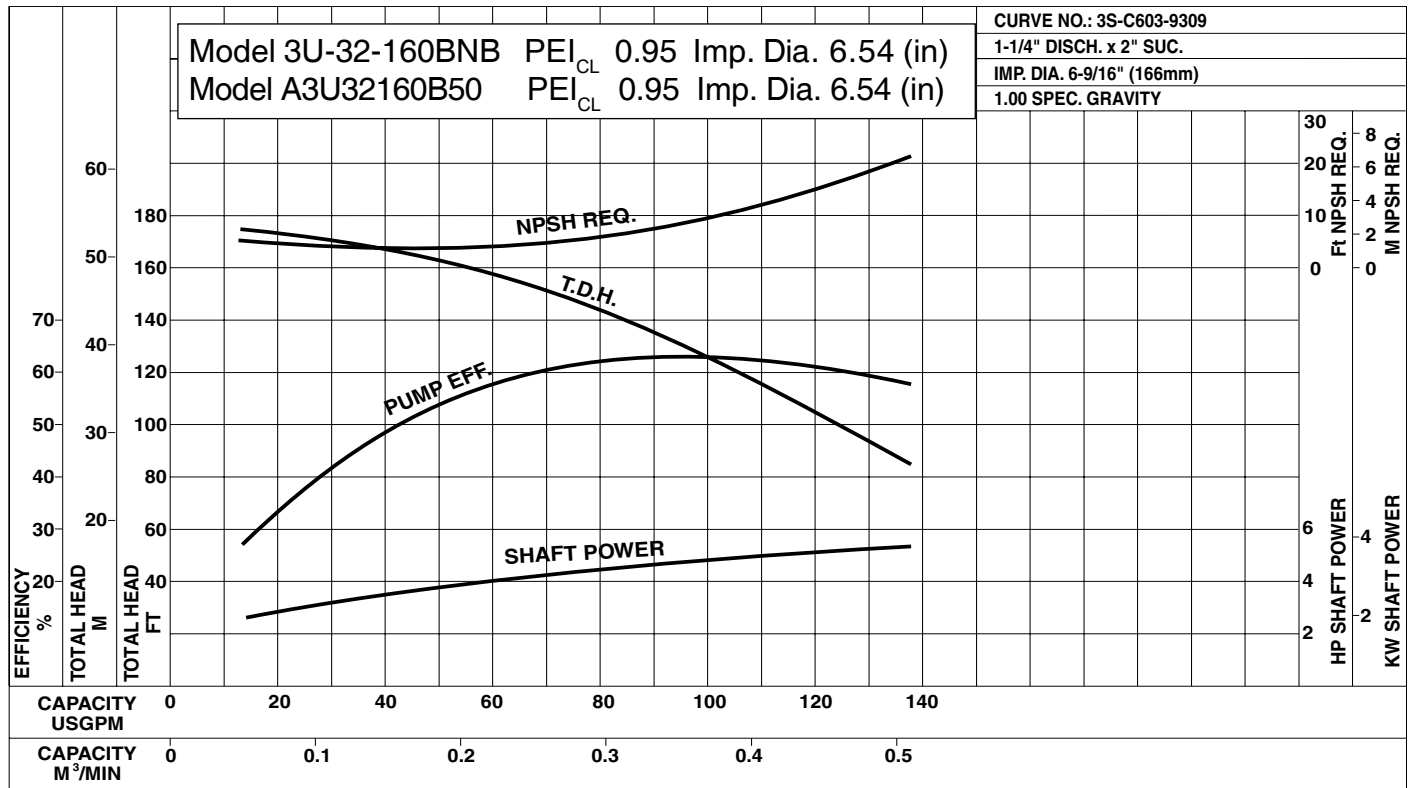

3U 32-200-7½HP

Nominal Speed: 3450 RPM

Size: 1¼ x 2 x 7⁵/₁₆

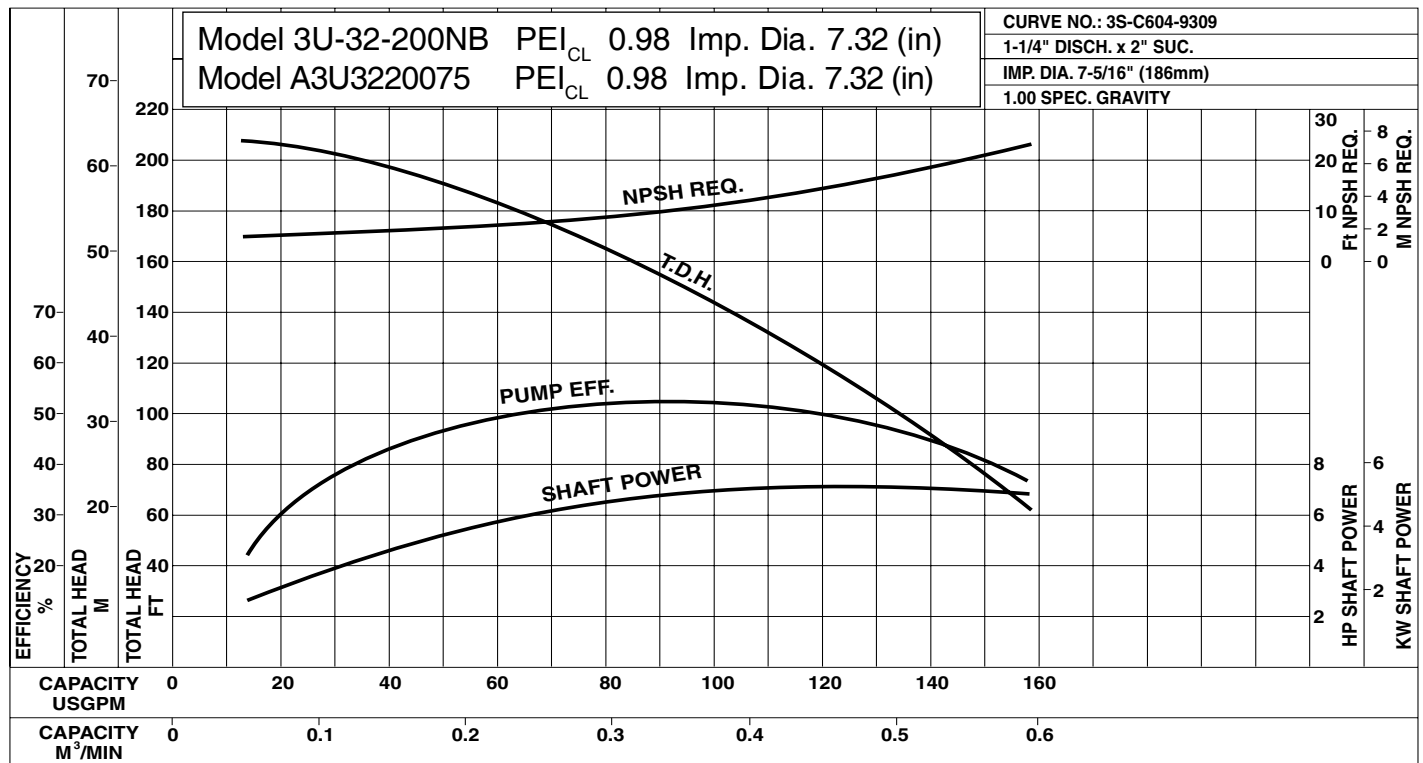

EBARA Stainless Steel Centrifugal Pumps

Model 3U

Performance Curves

3U 32-200-1-10HP

Nominal Speed: 3450 RPM

Size: 1 1/4 x 2 x 7 7/8

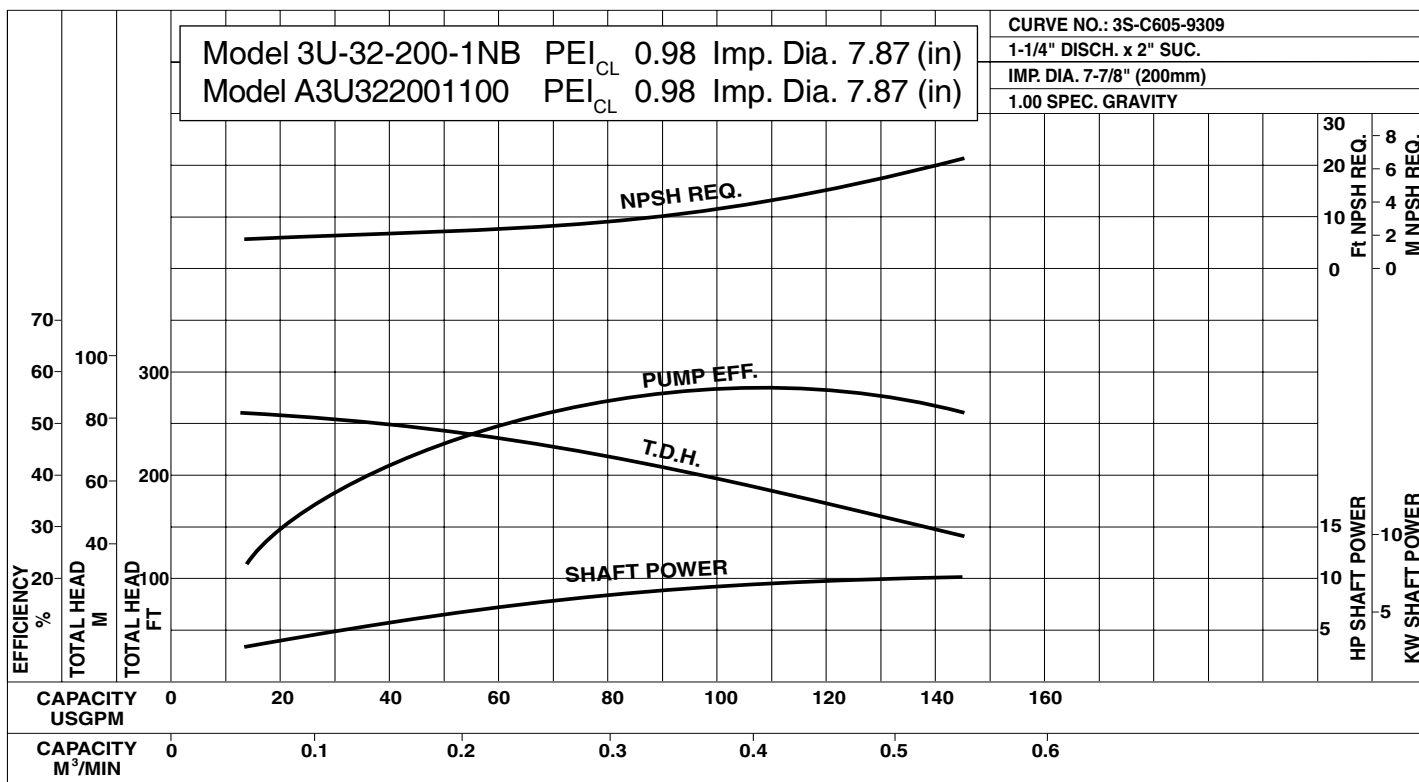

3U 40-125A-5HP

Nominal Speed: 3450 RPM

Size: 1 1/2 x 2 1/2 x 4 15/16

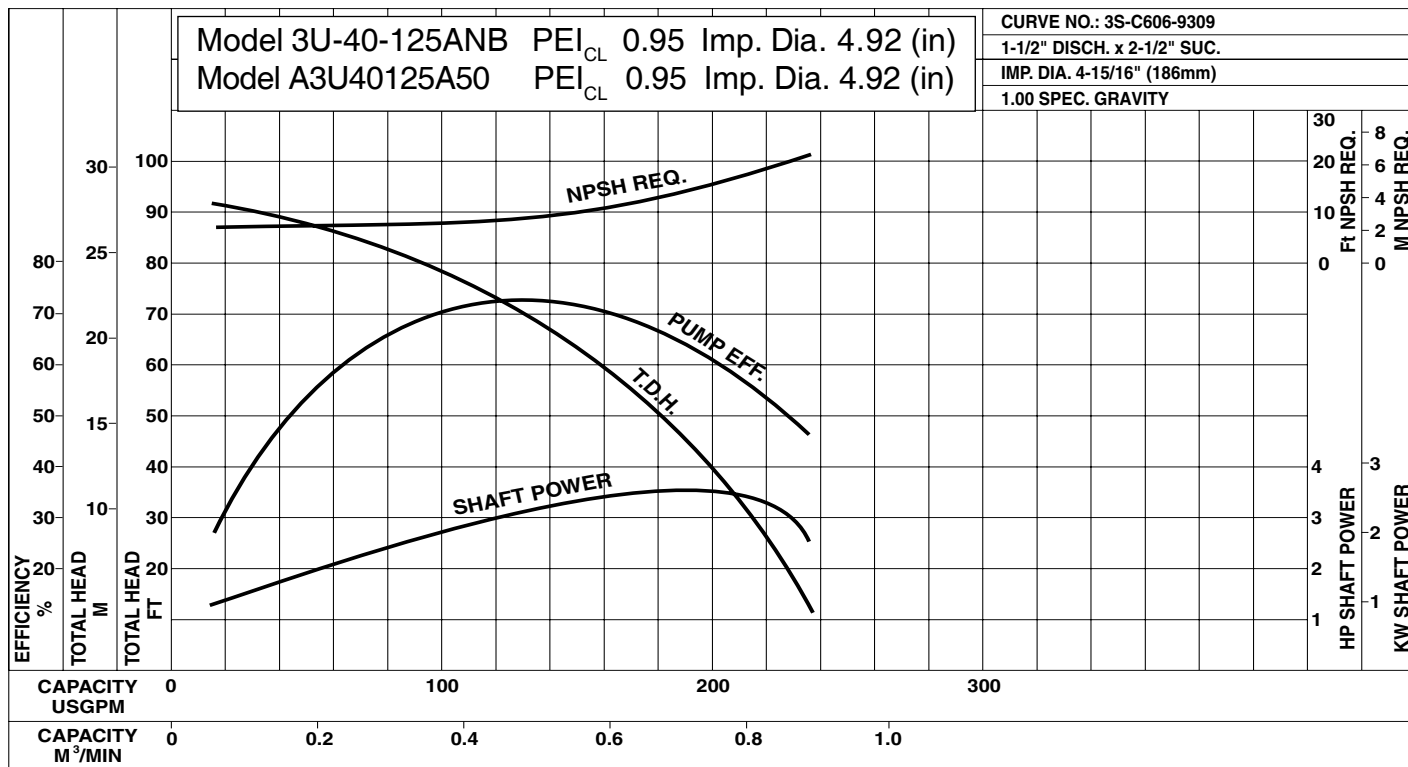

EBARA Stainless Steel Centrifugal Pumps

Model 3U

Performance Curves

3U 40-125B-5HP

Nominal Speed: 3450 RPM

Size: 1½ x 2½ x 5½

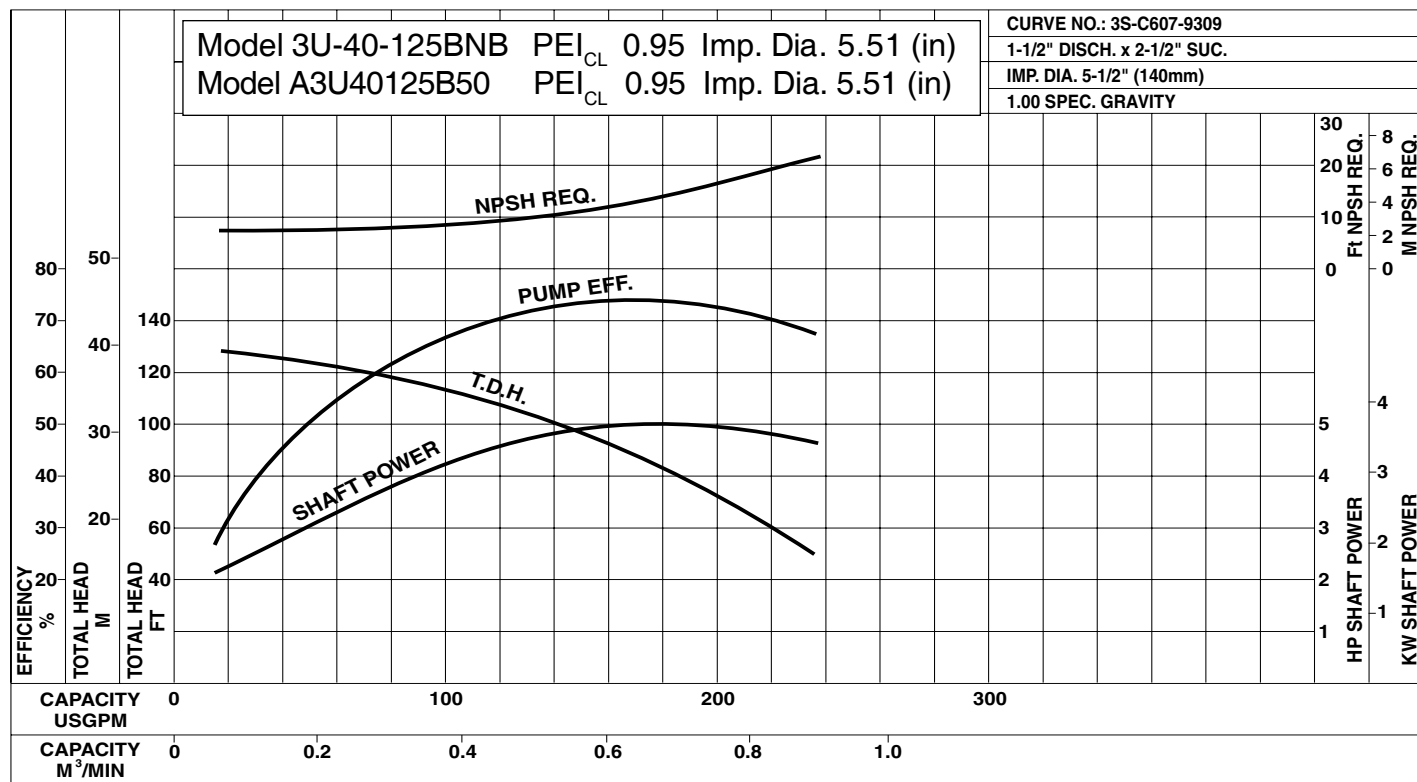

3U 40-160-7½HP

Nominal Speed: 3450 RPM

Size: 1½ x 2½ x 5¹⁵/₁₆

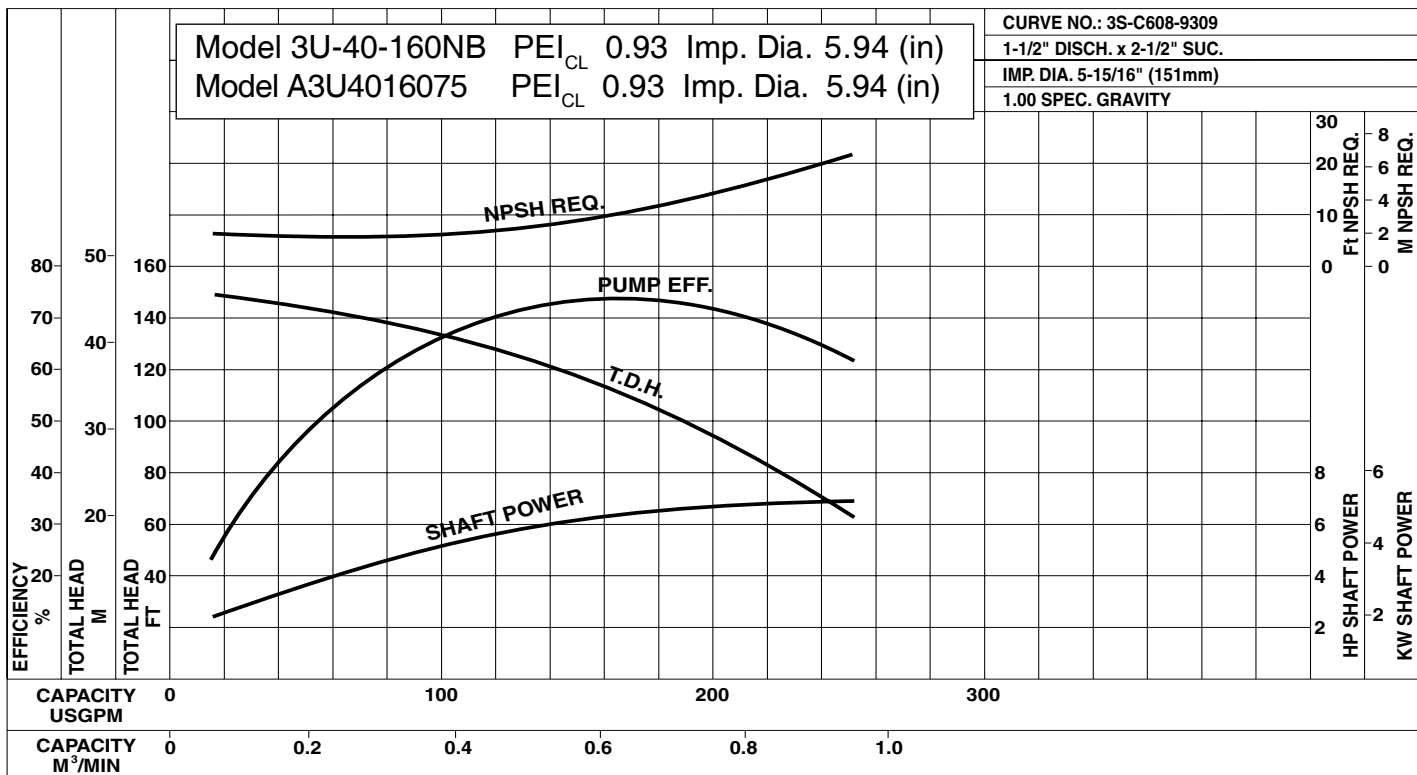

EBARA Stainless Steel Centrifugal Pumps

Model 3U

Performance Curves

3U 40-160-1-10HP

Nominal Speed: 3450 RPM

Size: 1½ x 2½ x 6⁹/₁₆

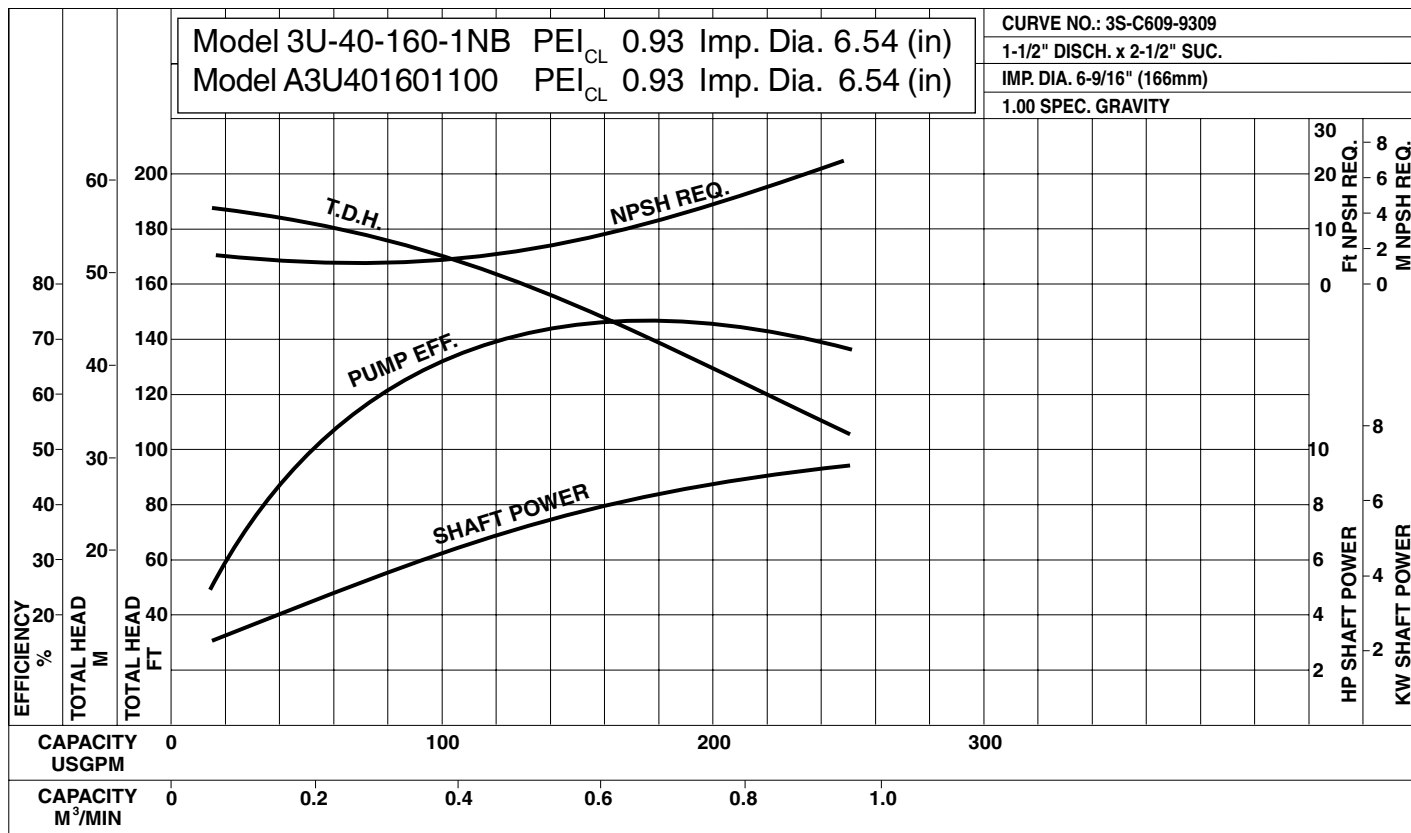

3U 40-200A-15HP

Nominal Speed: 3450 RPM

Size: 1½ x 2½ x 7³/₁₆

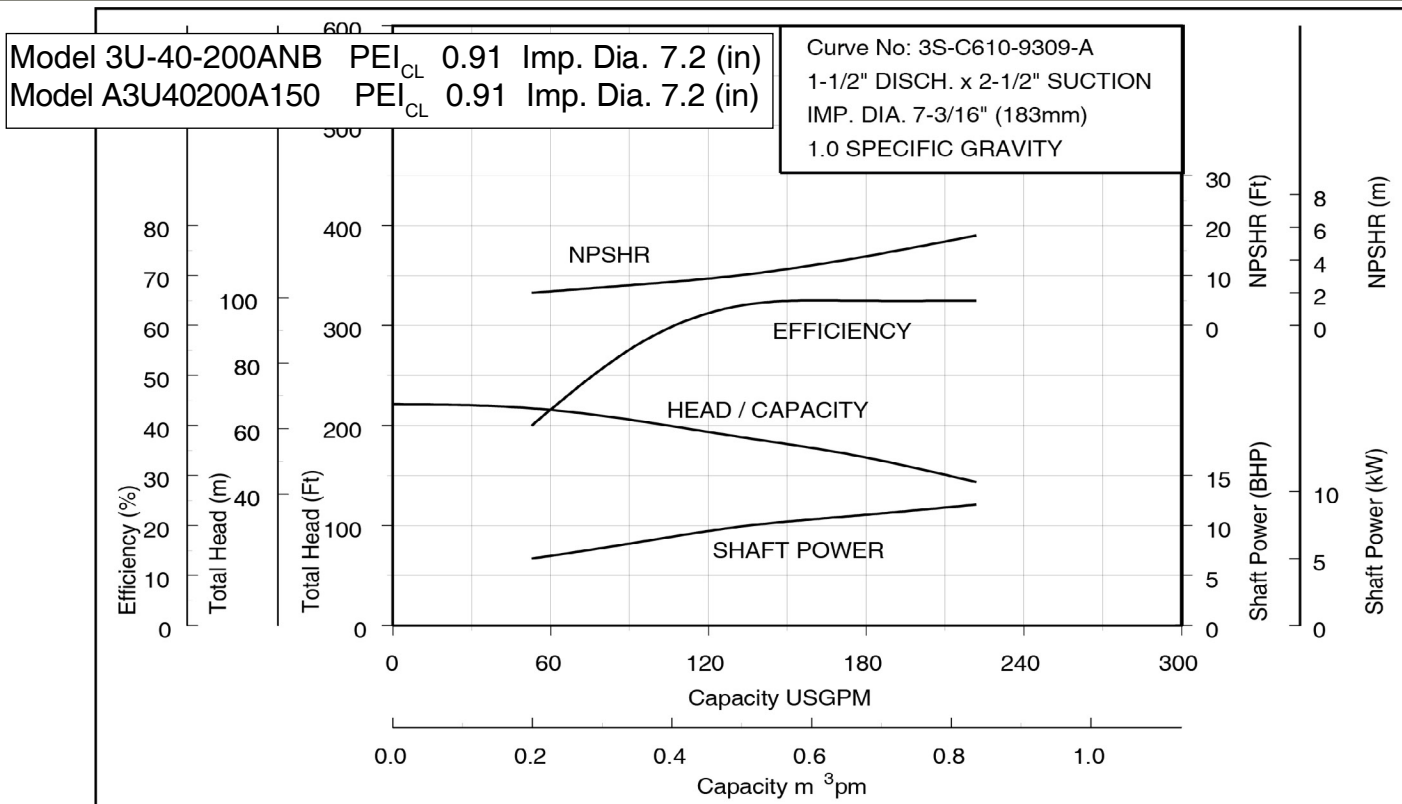

EBARA Stainless Steel Centrifugal Pumps

Model 3U

Performance Curves

3U 40-200B-15HP

Nominal Speed: 3450 RPM

Size: 1½ x 2½ x 7⅞

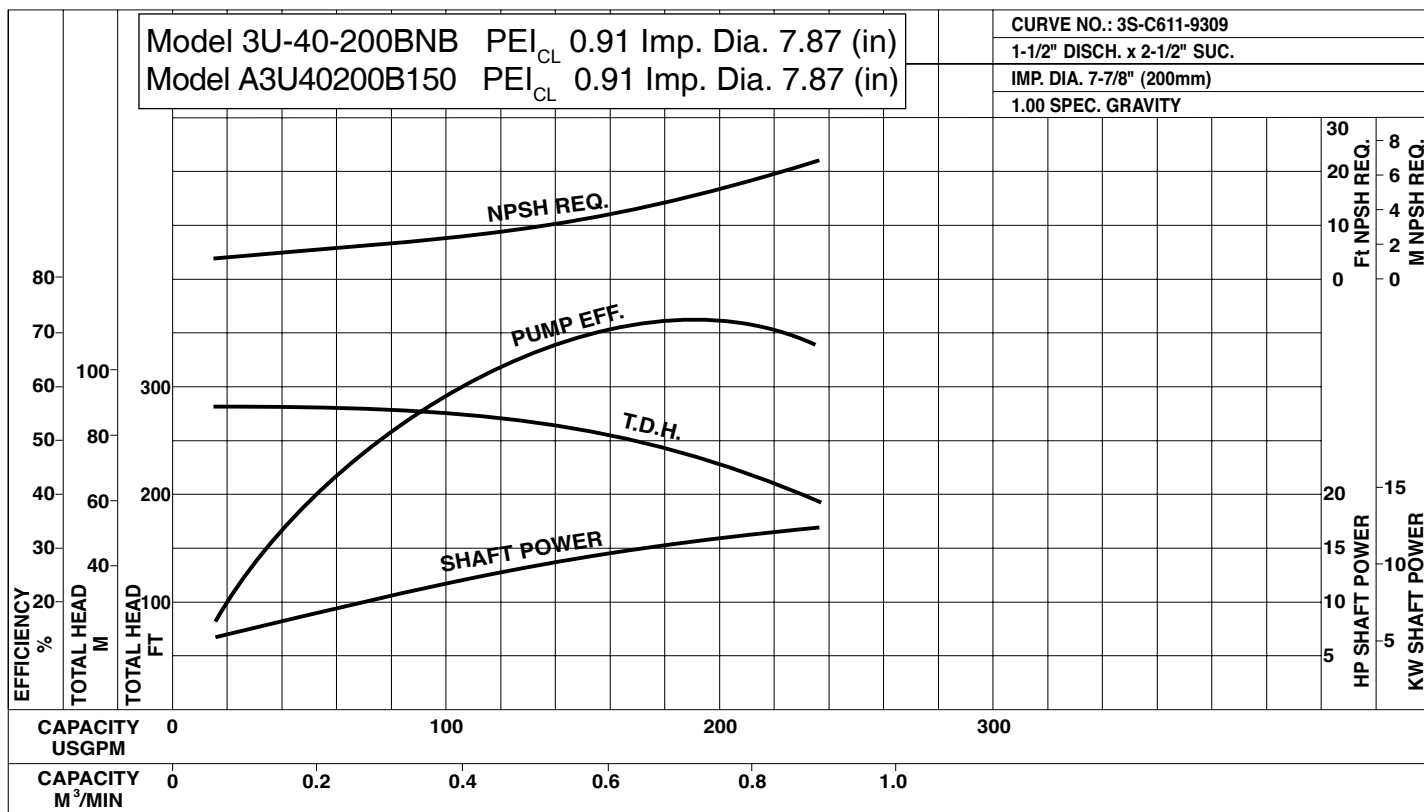

3U 50-125-7½HP

Nominal Speed: 3450 RPM

Size: 2 x 2½ x 5⅜

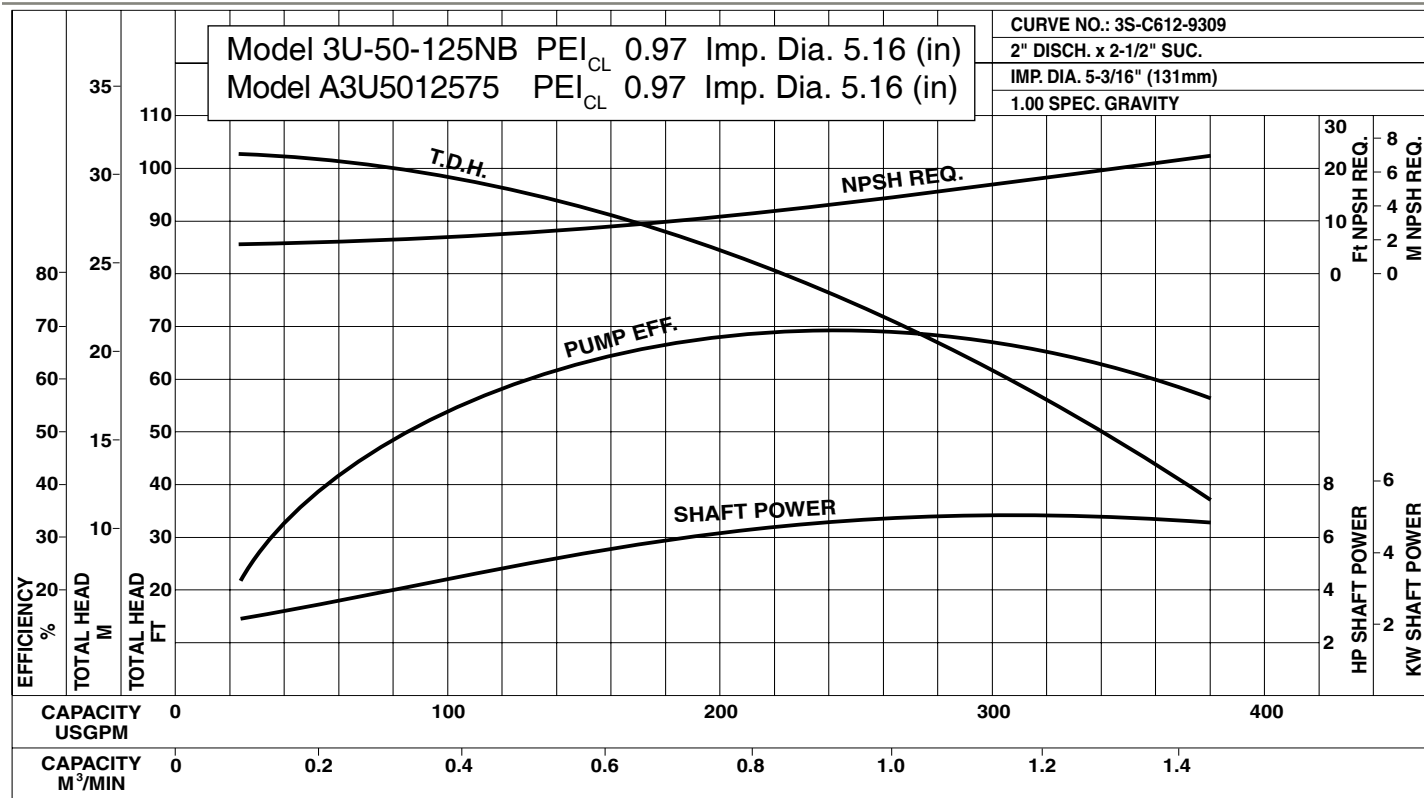

EBARA Stainless Steel Centrifugal Pumps

Model 3U

Performance Curves

3U 50-125-1-10HP

Nominal Speed: 3450 RPM

Size: 2 x 2½ x 5½

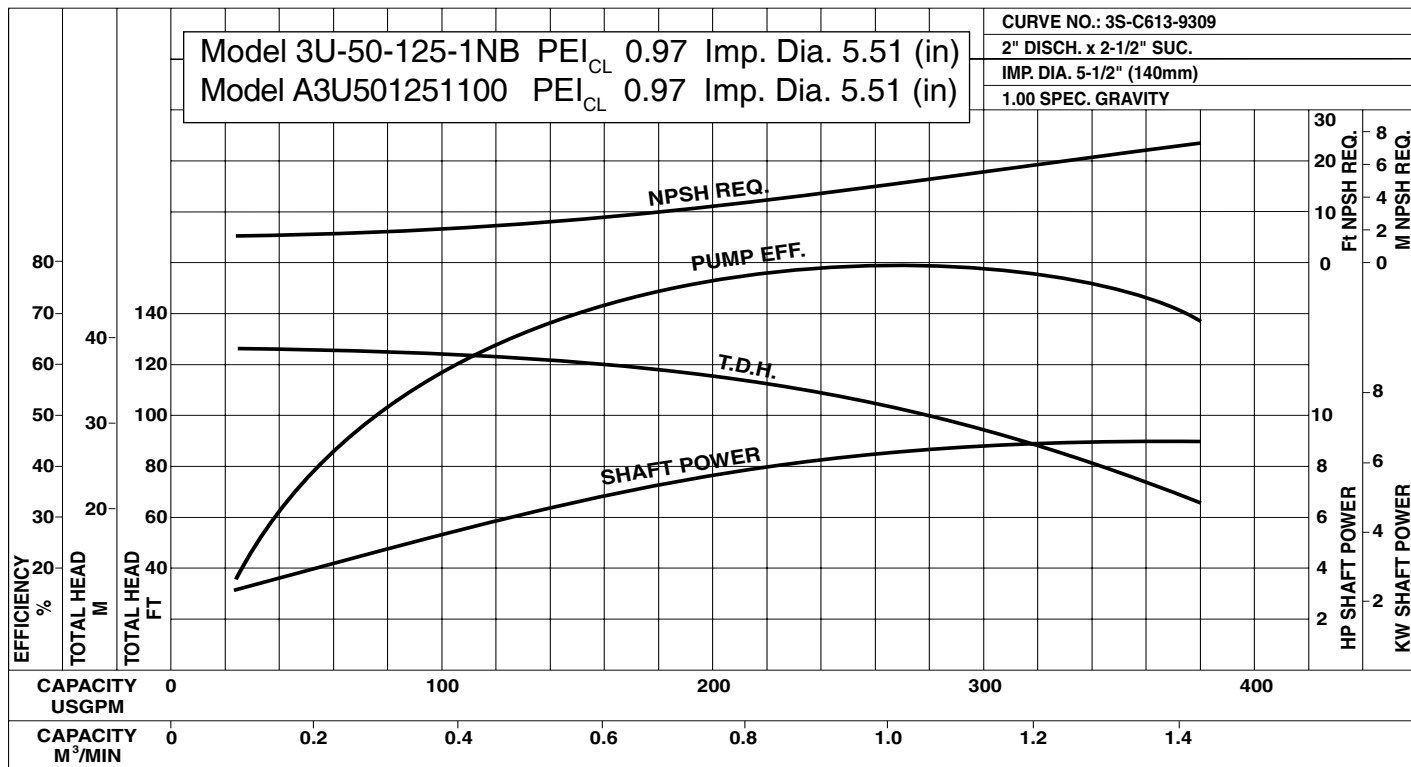

3U 50-160-10HP

Nominal Speed: 3450 RPM

Size: 2 x 2½ x 6¼

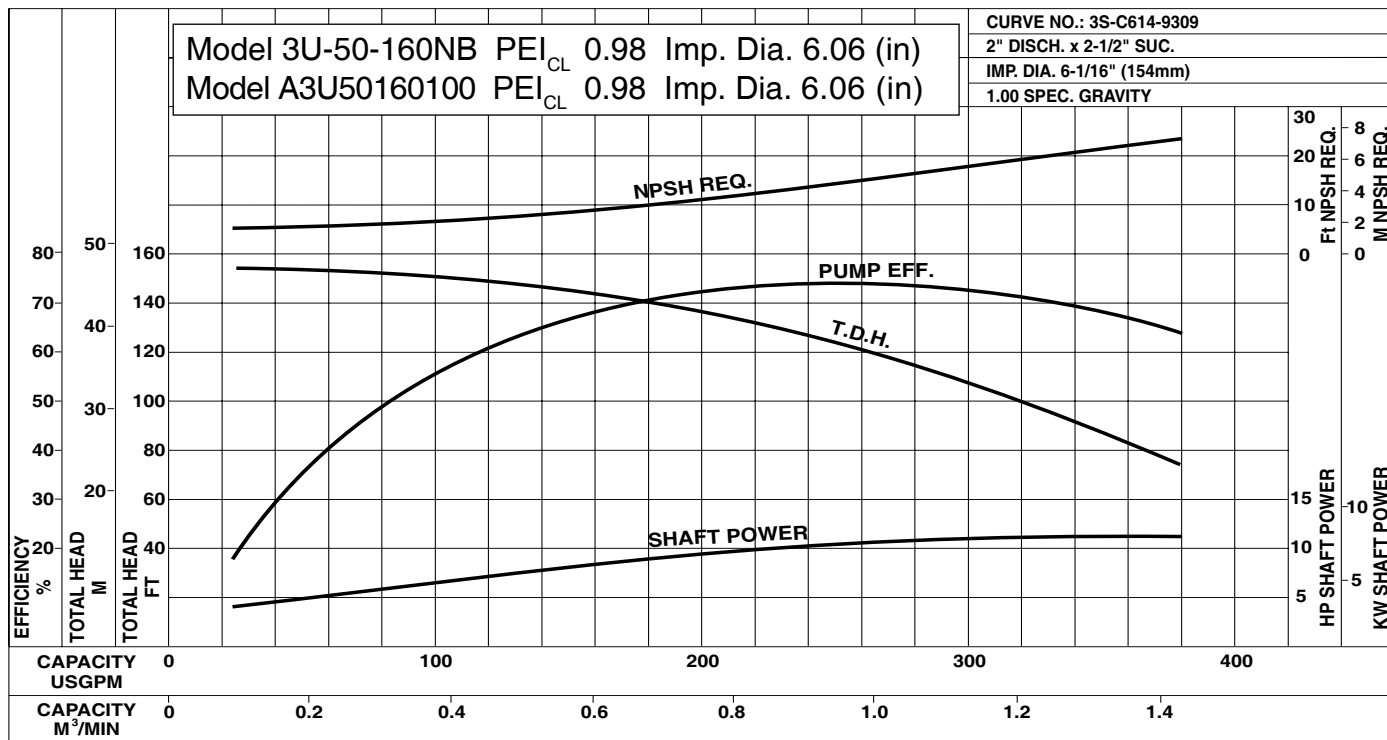

EBARA Stainless Steel Centrifugal Pumps

Model 3U

Performance Curves

3U 50-160-1-15HP

Nominal Speed: 3450 RPM

Size: 2 x 2½ x 6⅞

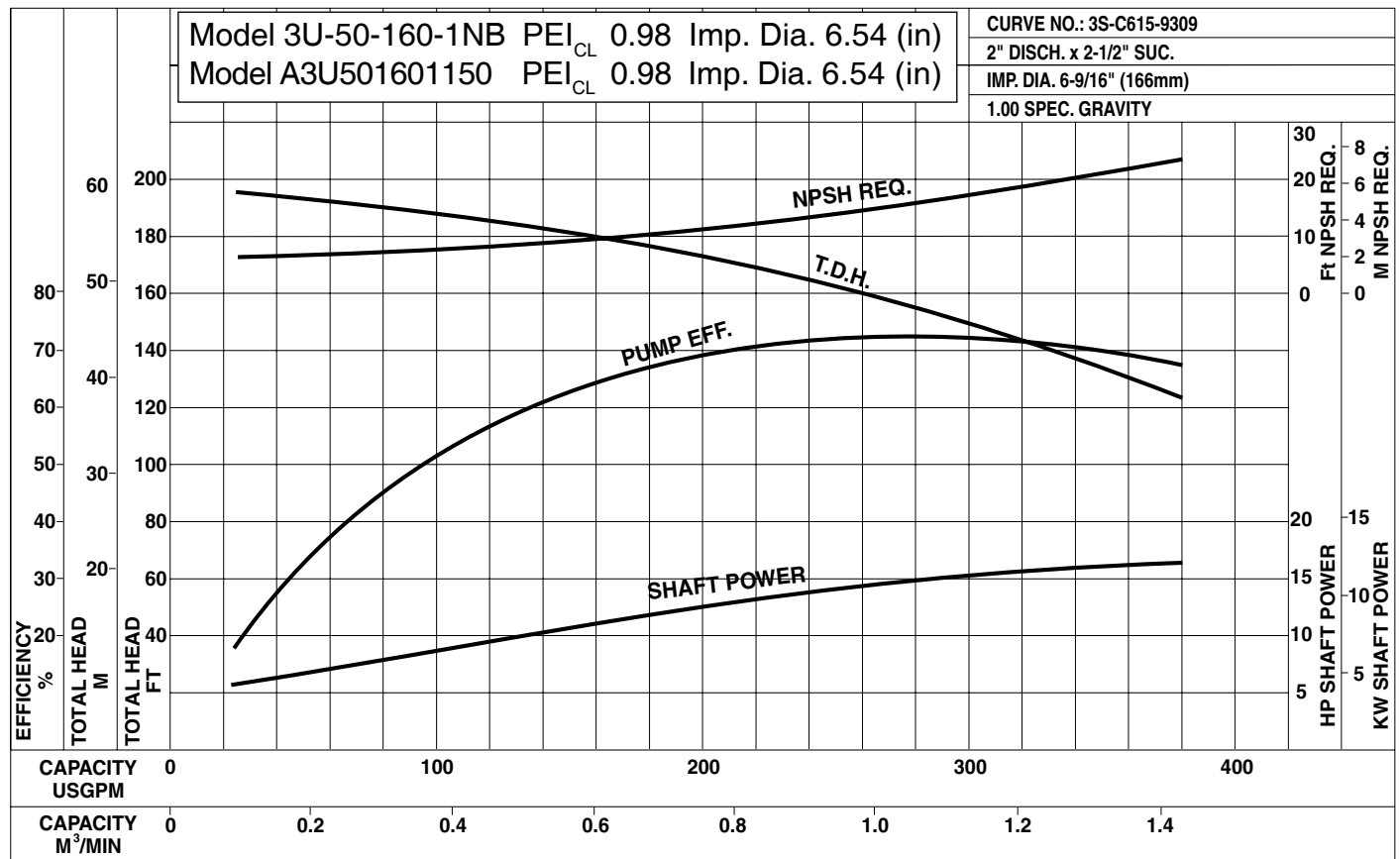

Illinois Location:
 (847) 841-7867
 860 Church Rd Elgin, IL 60120

Minnesota Location:
 (651) 758-7867
 330 Mill Bay South Suite 100
 Afton, MN 55001

PumpSupplyInc.com



PS **PUMP SUPPLY**
INCORPORATED



EBARA Stainless Steel Centrifugal Pumps

Model 3U

Performance Curves

3U 65-125-7.5HP

Nominal Speed: 3450 RPM

Size: 2½ x 3 x 4¾ (124 mm)

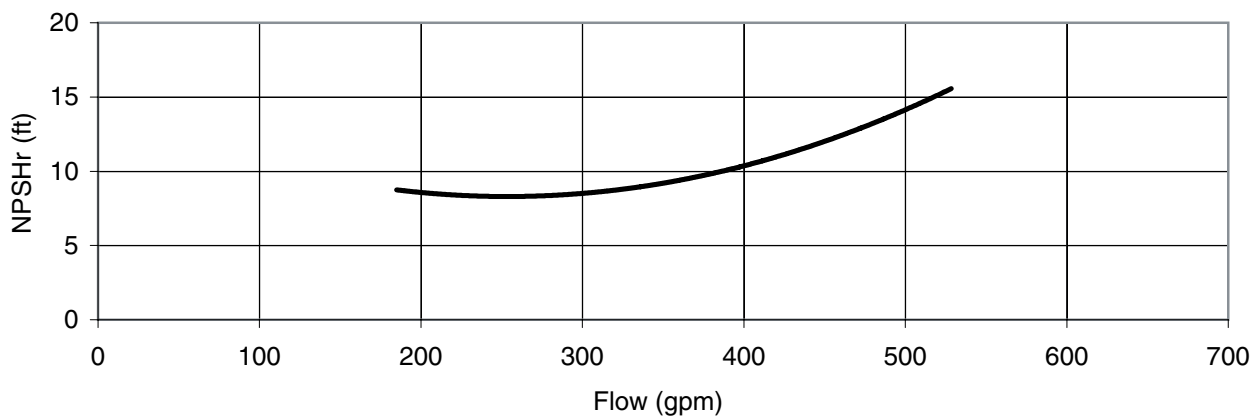
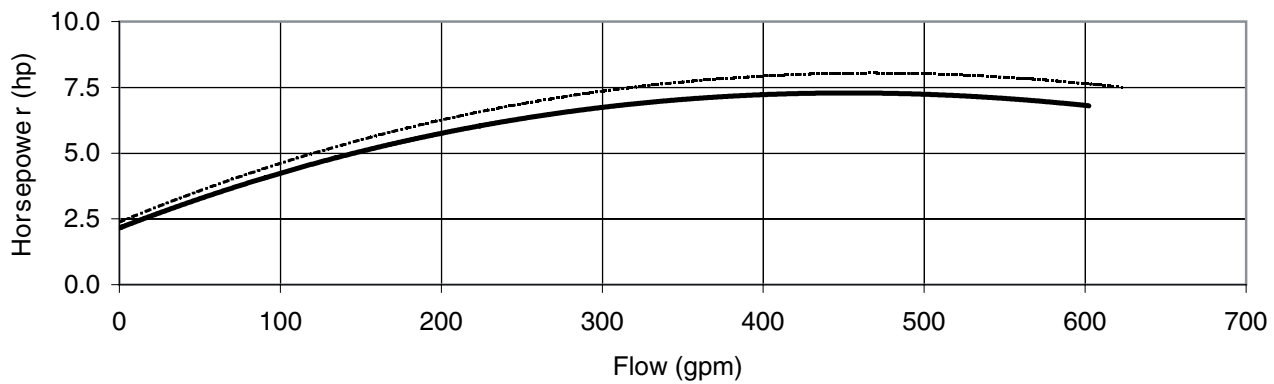
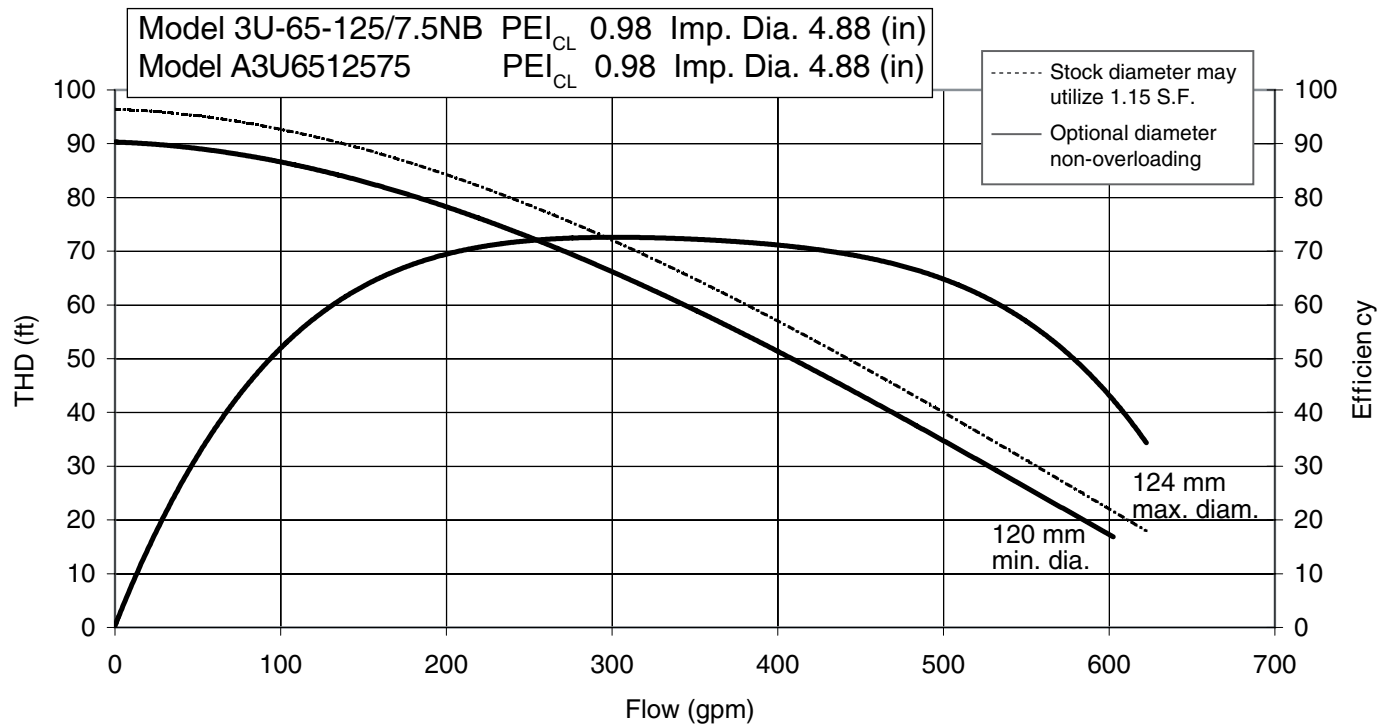

EBARA Stainless Steel Centrifugal Pumps

Model 3U

Performance Curves

3U 65-125-10HP

Nominal Speed: 3450 RPM

Size: 2½ x 3 x 5⁵/₁₆ (135 mm)

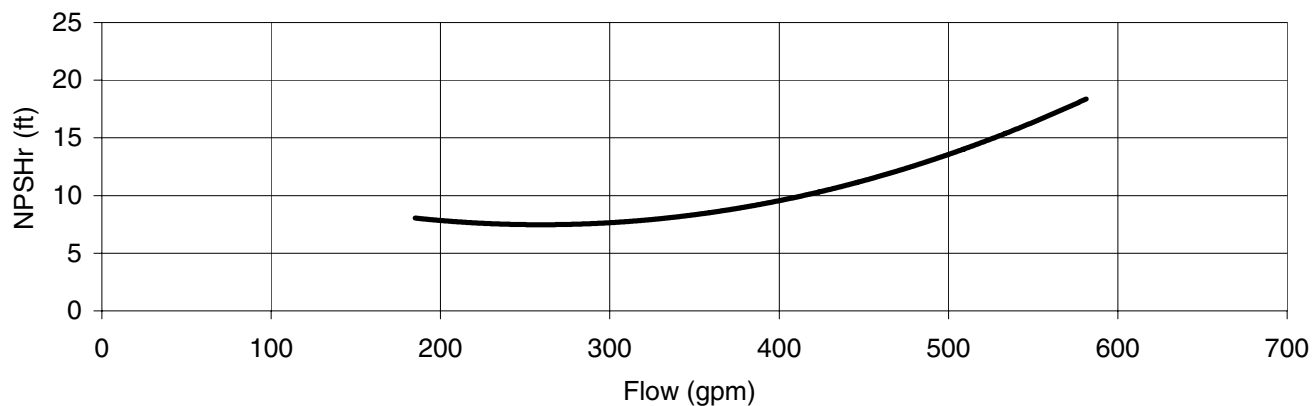
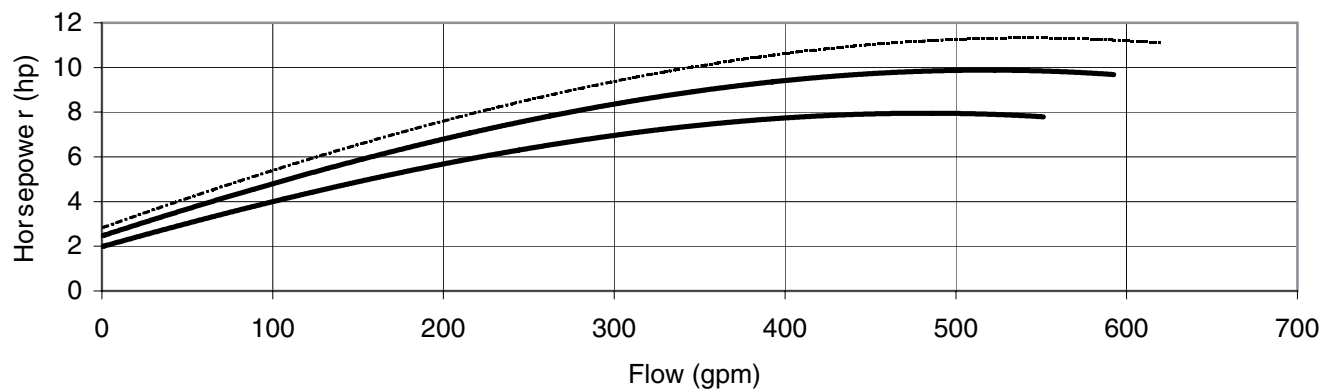
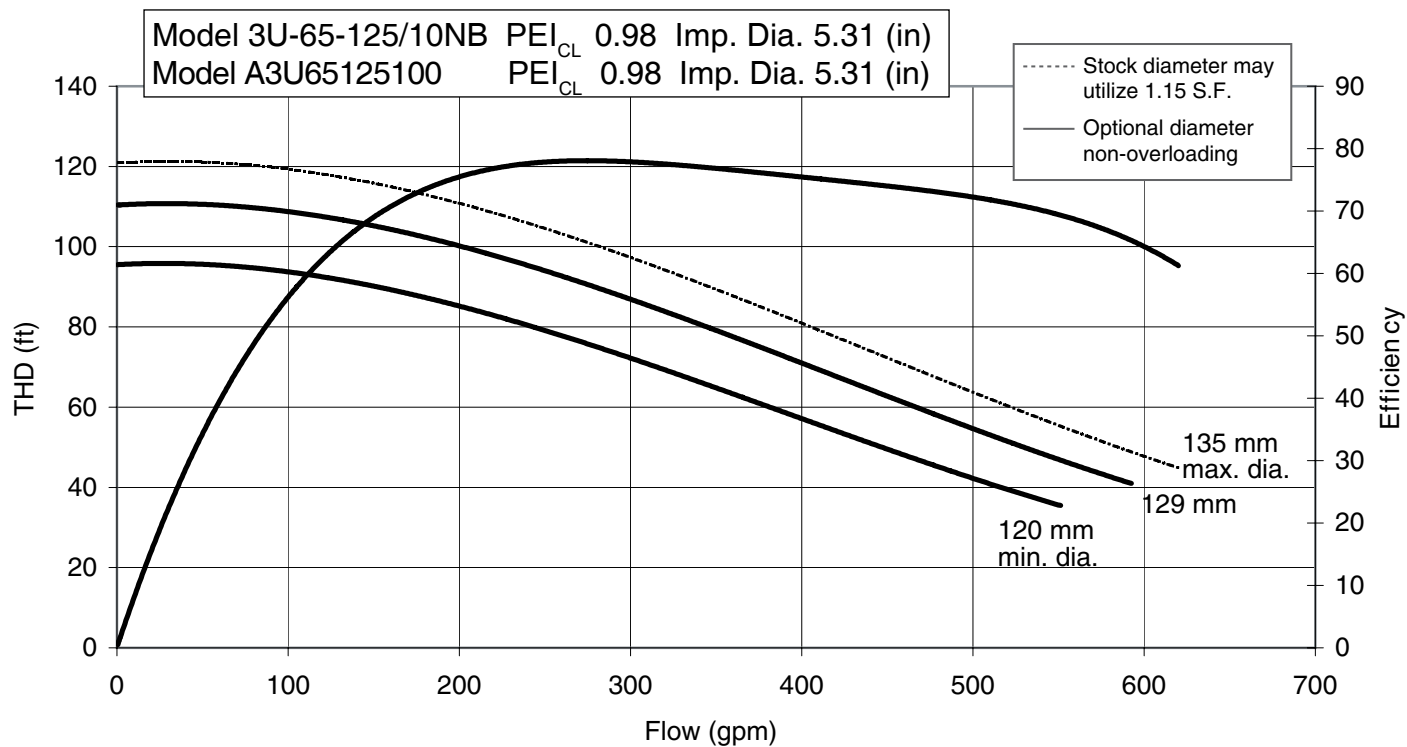

EBARA Stainless Steel Centrifugal Pumps

Model 3U

Performance Curves

3U 65-125-15HP

Nominal Speed: 3450 RPM

Size: 2½ x 3 x 5½ (140 mm)

Model 3U-65-125/15NB PEI_{CL} 0.98 Imp. Dia. 5.51 (in)
 Model A3U65125150 PEI_{CL} 0.98 Imp. Dia. 5.51 (in)

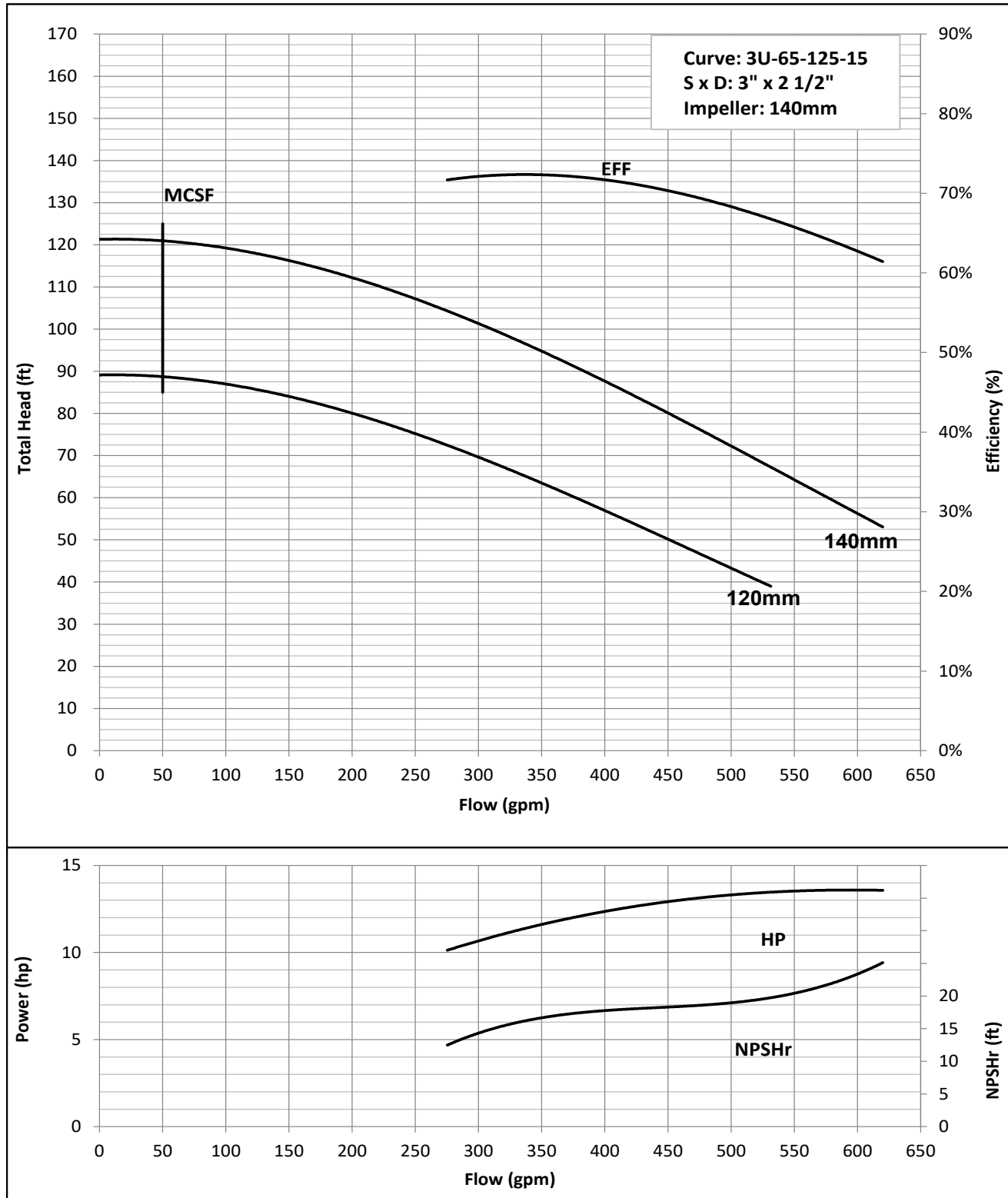

EBARA Stainless Steel Centrifugal Pumps

Model 3U

Performance Curves

3U 65-125-20HP

Nominal Speed: 3450 RPM

Size: 2½ x 3 x 5⅞ (149 mm)

Model 3U-65-125/20NB PEI_{CL} 0.98 Imp. Dia. 5.87 (in)
 Model A3U65125200 PEI_{CL} 0.98 Imp. Dia. 5.87 (in)

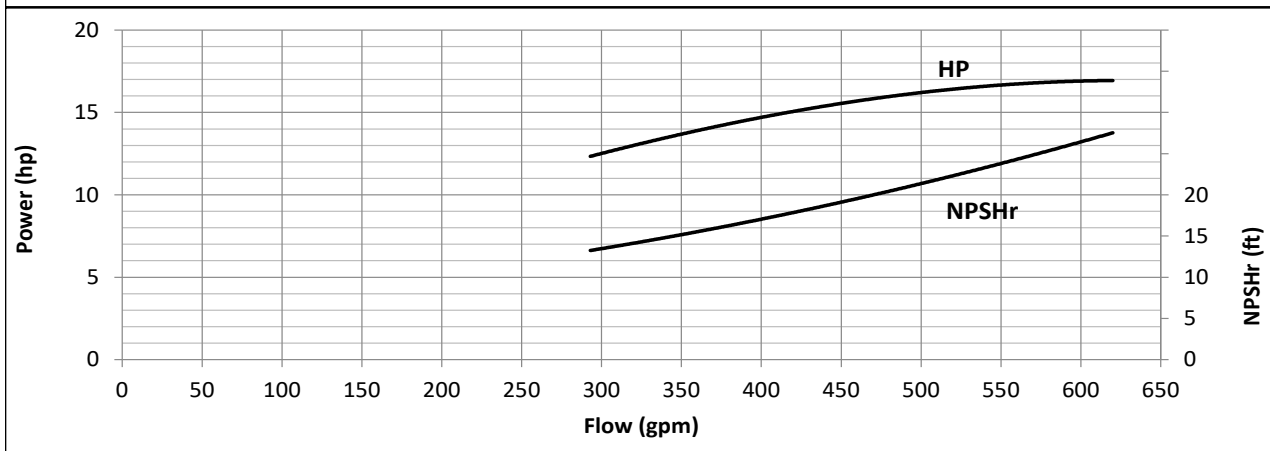
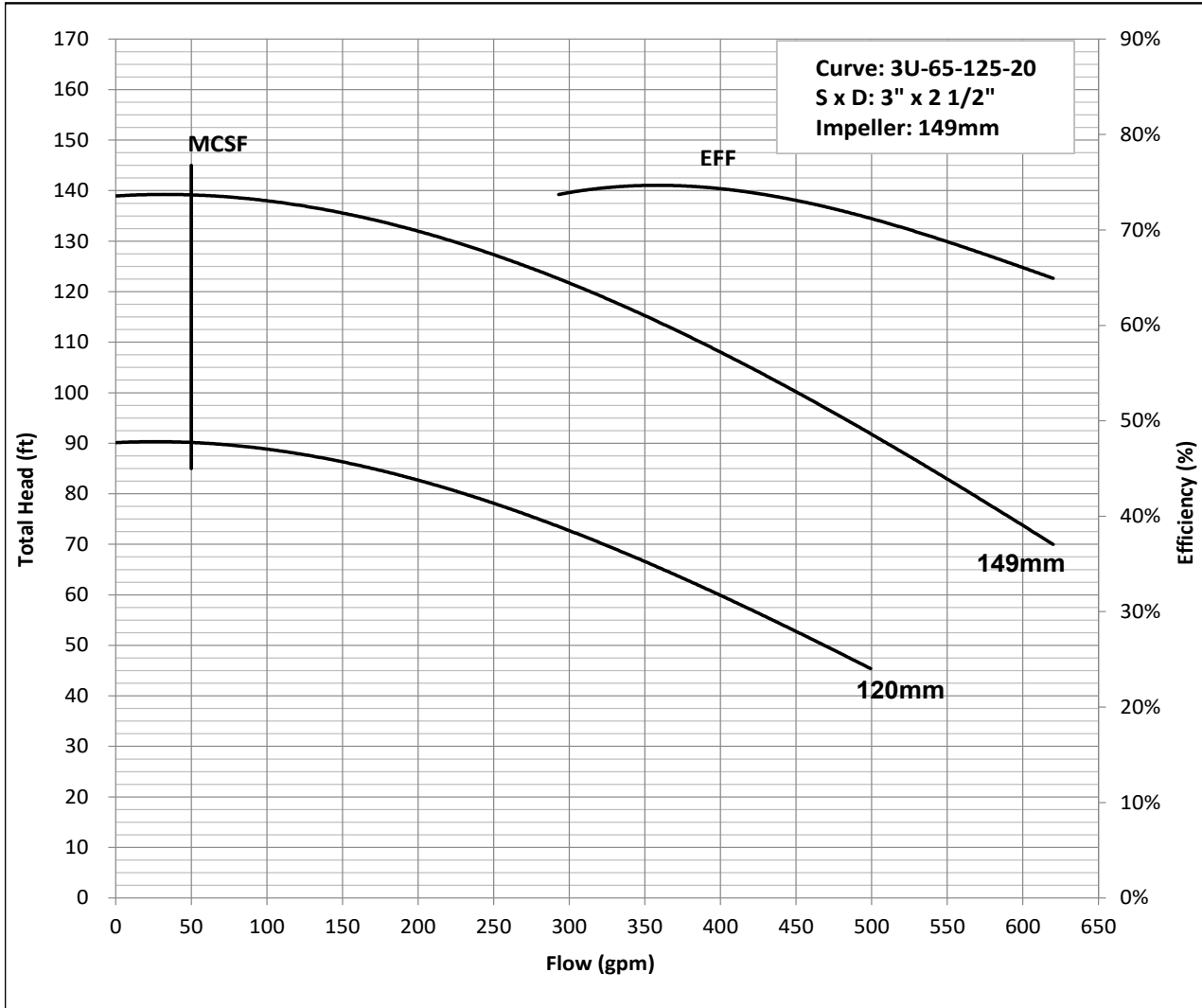

EBARA Stainless Steel Centrifugal Pumps

Model 3U

Performance Curves

3U 65-160-10HP

Nominal Speed: 3450 RPM

Size: 2½ x 3 x 5¼ (134 mm)

Model 3U-65-160/10NB PEI_{CL} 0.99 Imp. Dia. 5.28 (in)
 Model A3U65160100 PEI_{CL} 0.99 Imp. Dia. 5.28 (in)

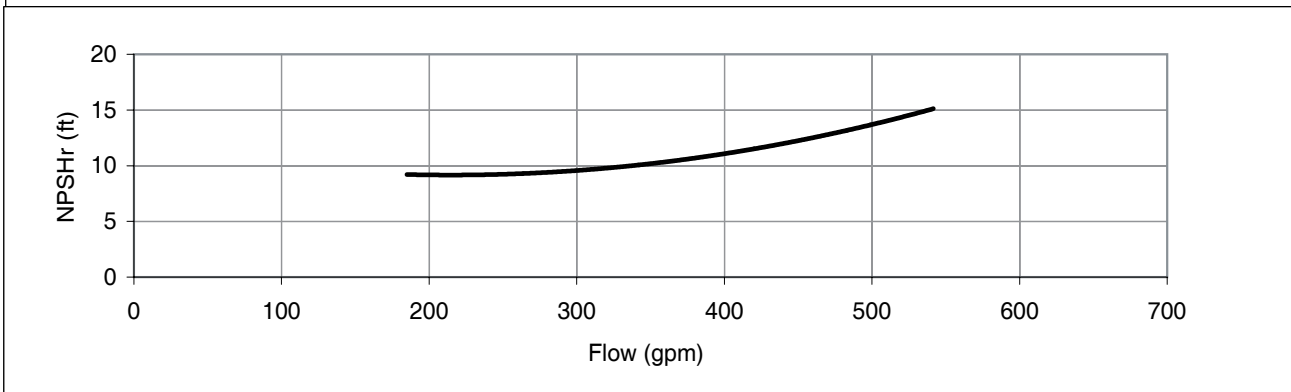
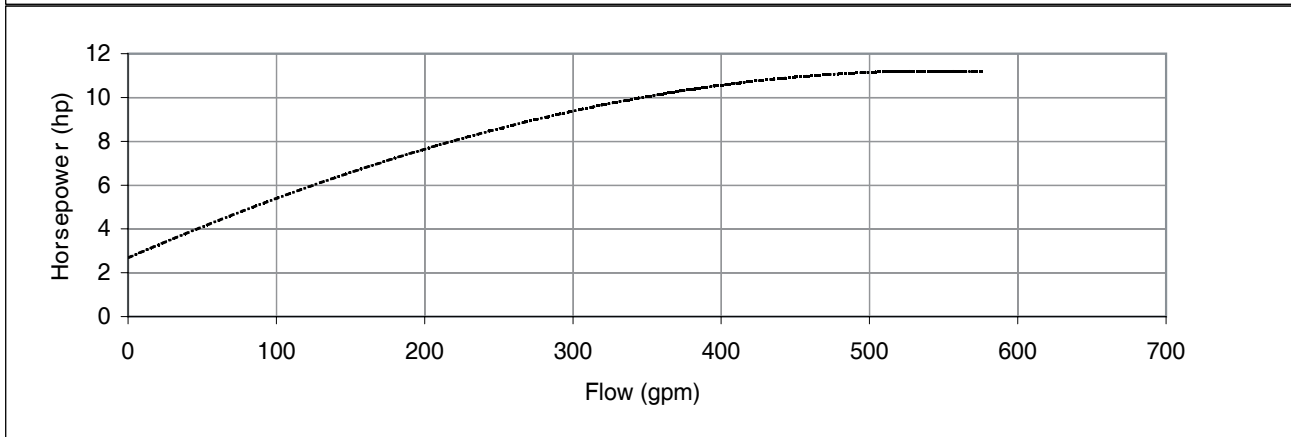
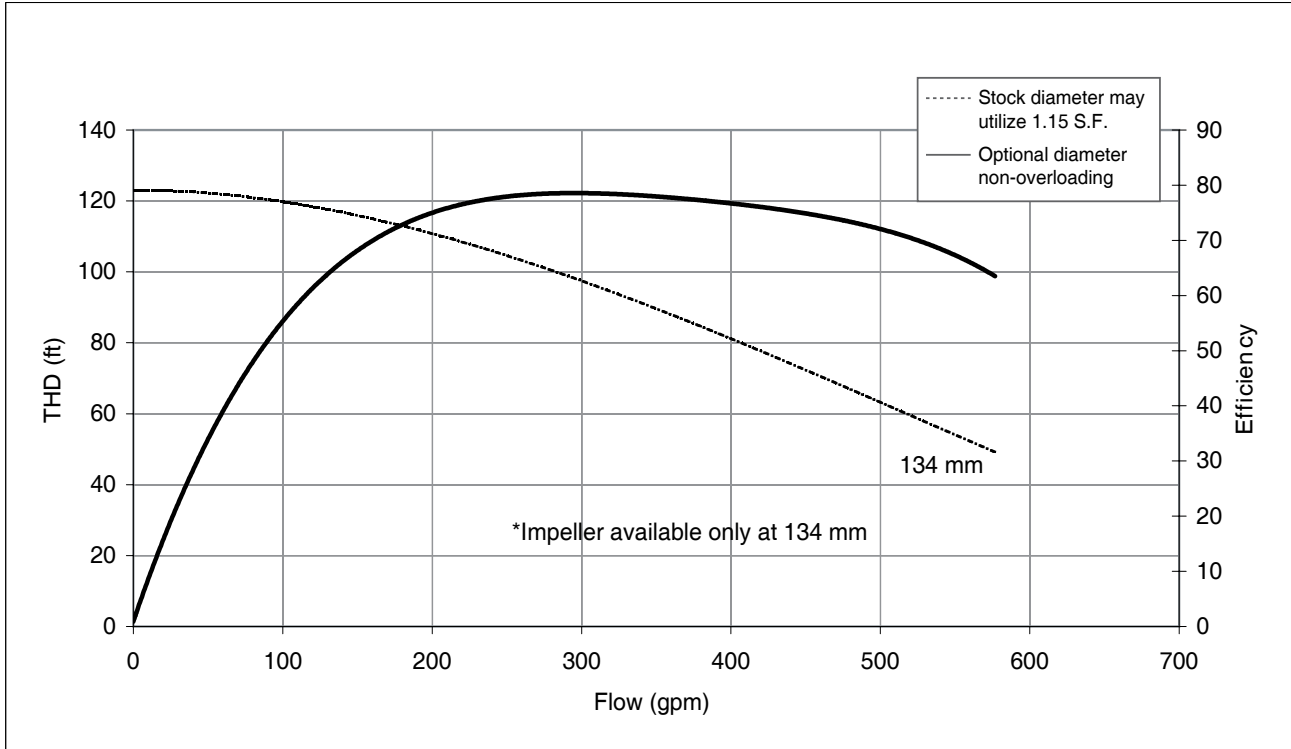

EBARA Stainless Steel Centrifugal Pumps

Model 3U

Performance Curves

3U 65-160-15HP

Nominal Speed: 3450 RPM

Size: 2½ x 3 x 5¹³/₁₆ (148 mm)

Model 3U-65-160/15NB PEI_{CL} 0.99 Imp. Dia. 5.83 (in)
 Model A3U65160150 PEI_{CL} 0.99 Imp. Dia. 5.83 (in)

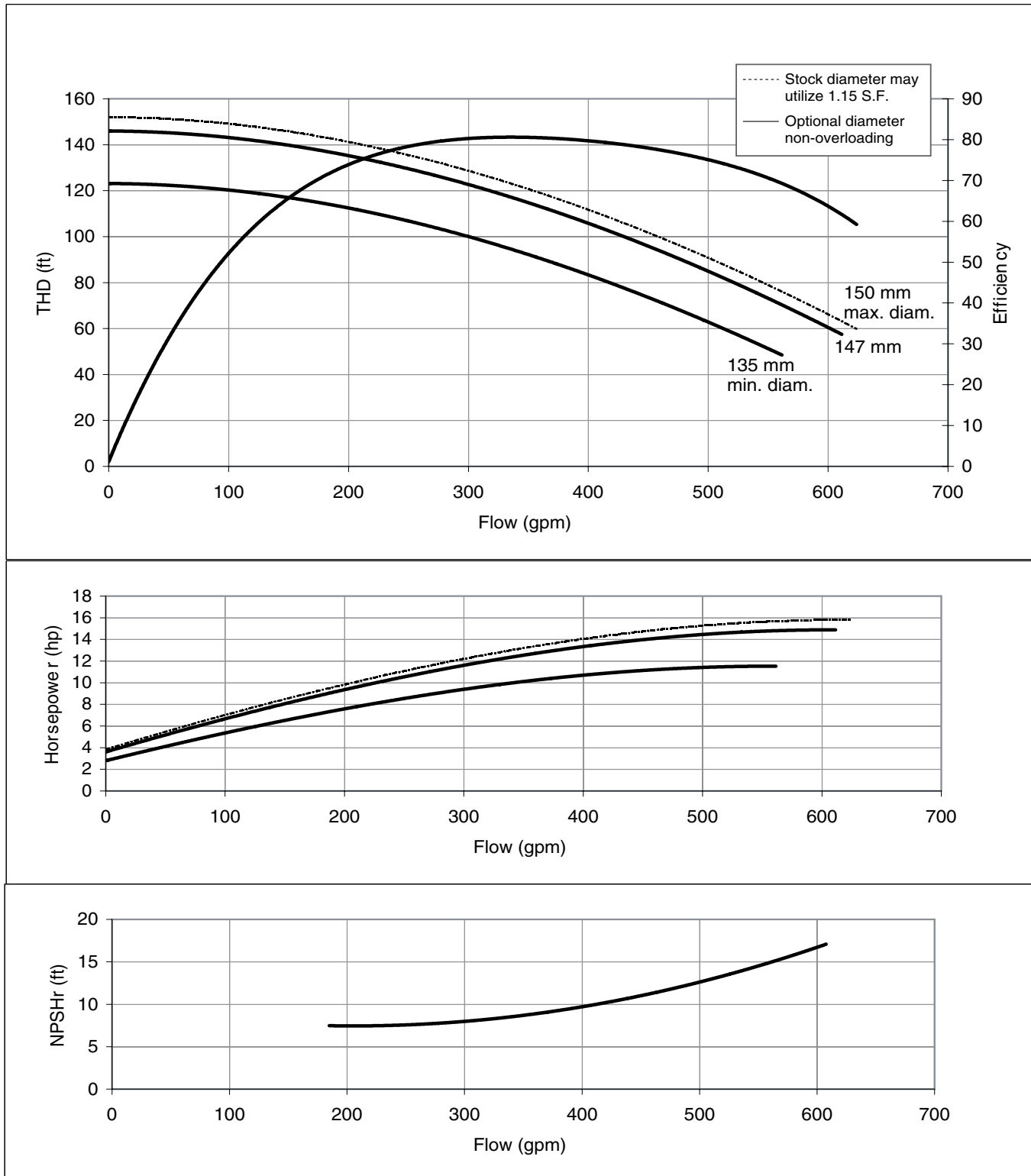

EBARA Stainless Steel Centrifugal Pumps

Model 3U

Performance Curves

3U 65-160-20HP

Nominal Speed: 3450 RPM

Size: 2½ x 3 x 6⁵/₁₆ (160 mm)

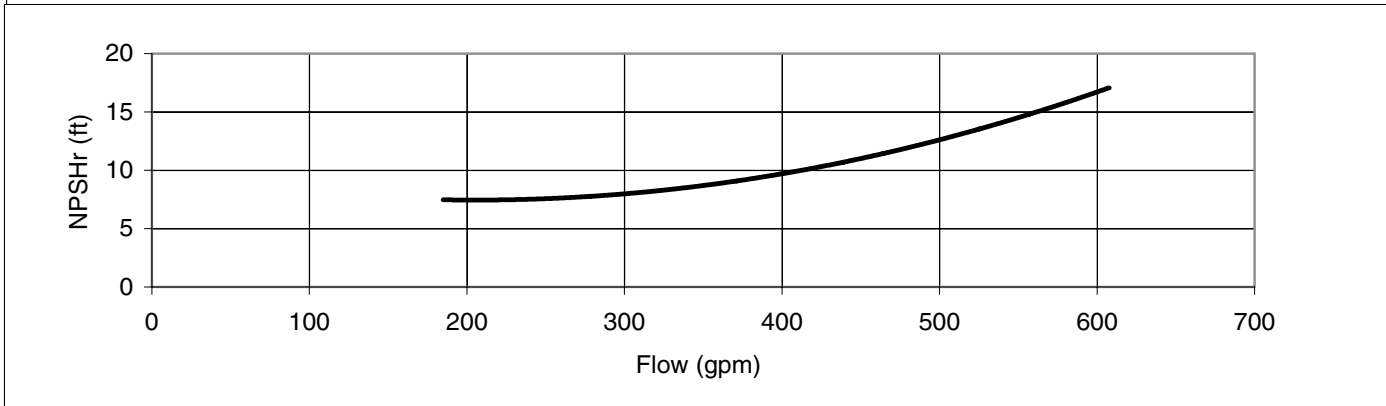
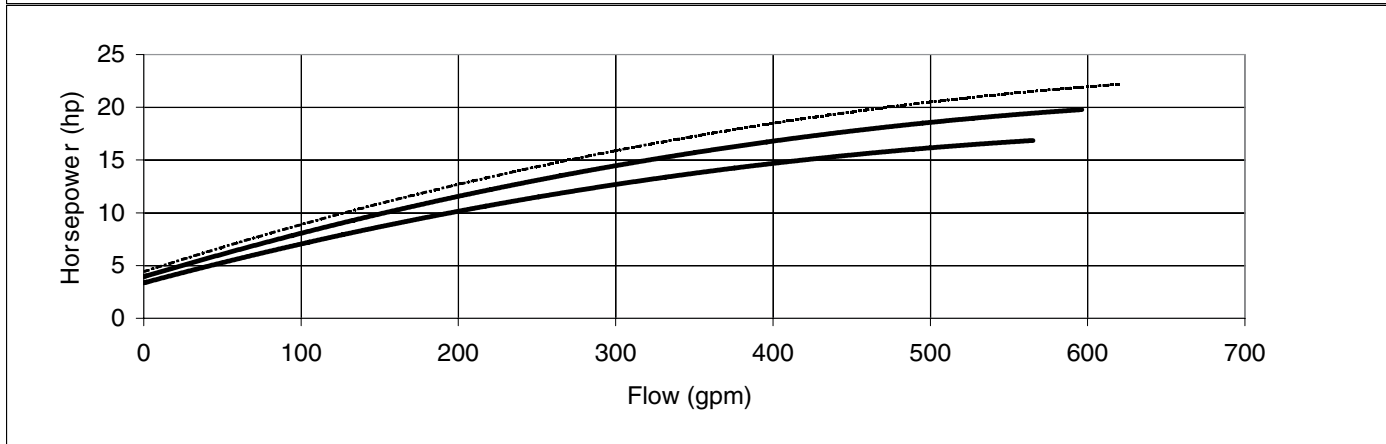
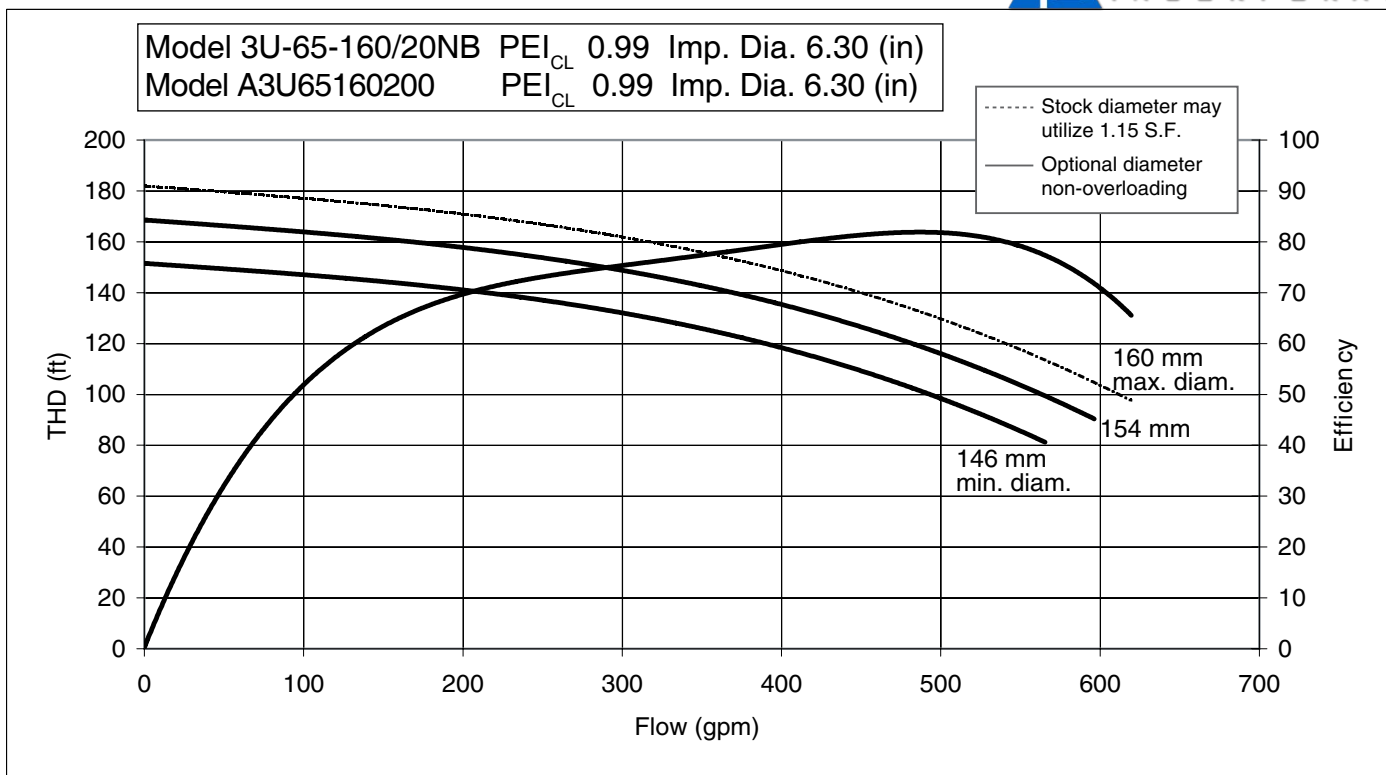

EBARA Stainless Steel Centrifugal Pumps

Model 3U

Performance Curves

3U 65-160-25HP

Nominal Speed: 3450 RPM

Size: 2½ x 3 x 6⅞ (174 mm)

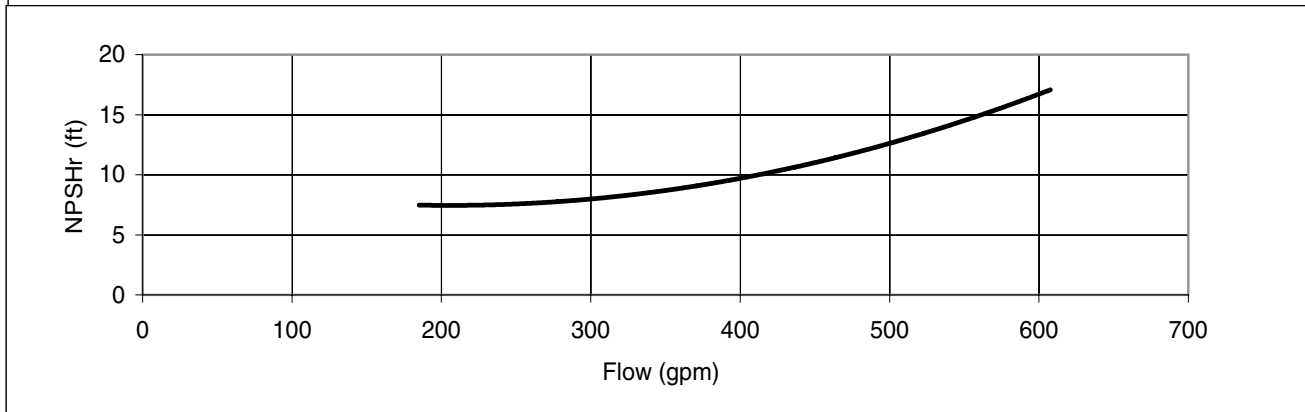
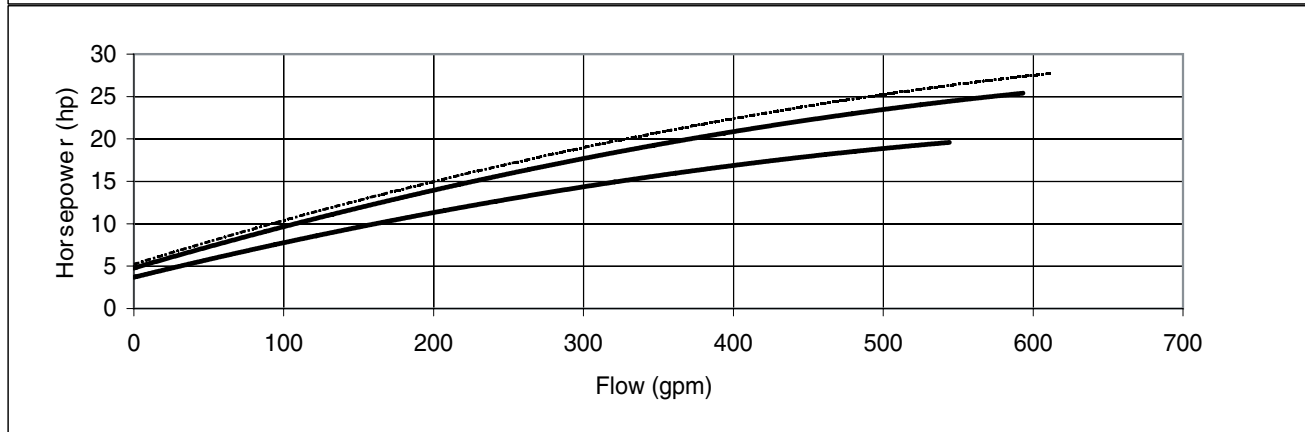
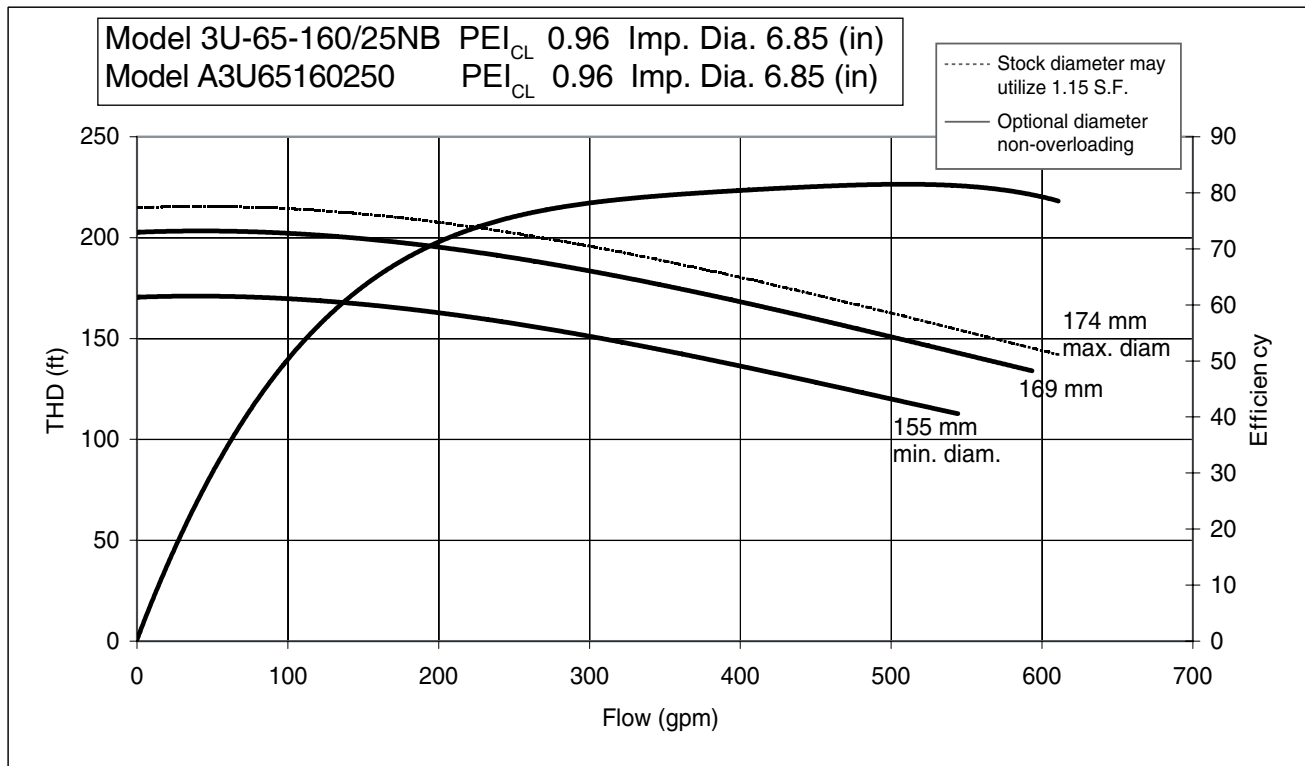

EBARA Stainless Steel Centrifugal Pumps

Model 3U

Performance Curves

3U 65-200-20HP

Nominal Speed: 3450 RPM

Size: 2½ x 3 x 6¾ (171 mm)

Model 3U-65-200/20NB PEI_{CL} 0.97 Imp. Dia. 6.73 (in)
 Model A3U65200200 PEI_{CL} 0.97 Imp. Dia. 6.73 (in)

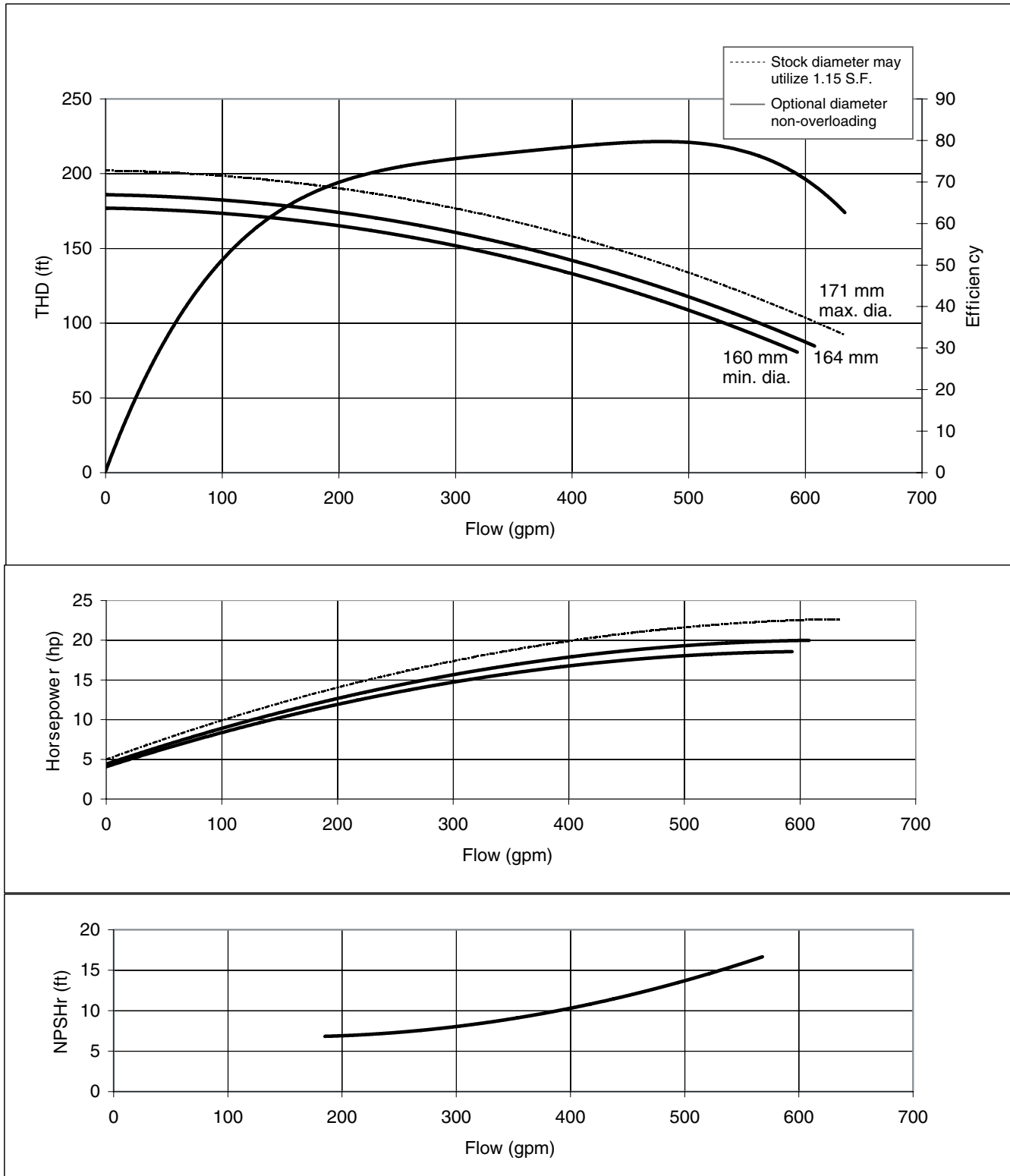

EBARA Stainless Steel Centrifugal Pumps

Model 3U

Performance Curves

3U 65-200-25HP

Nominal Speed: 3450 RPM

Size: 2½ x 3 x 7½ (179 mm)

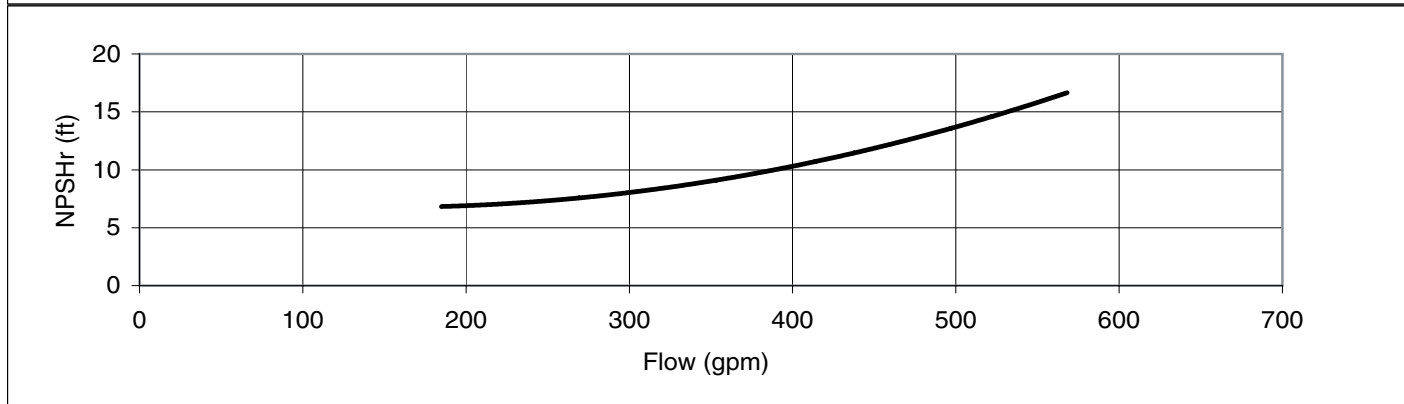
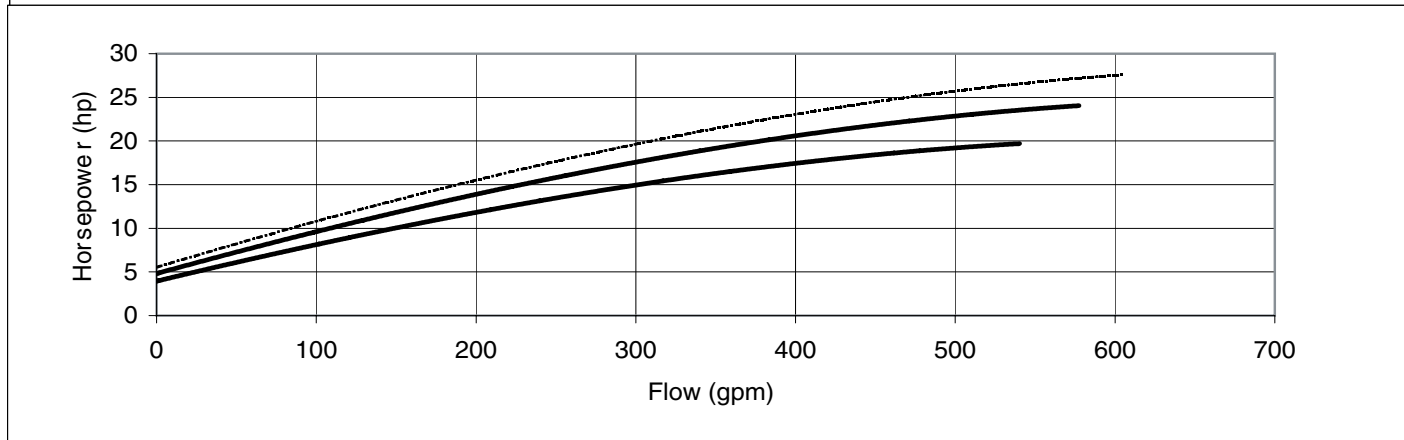
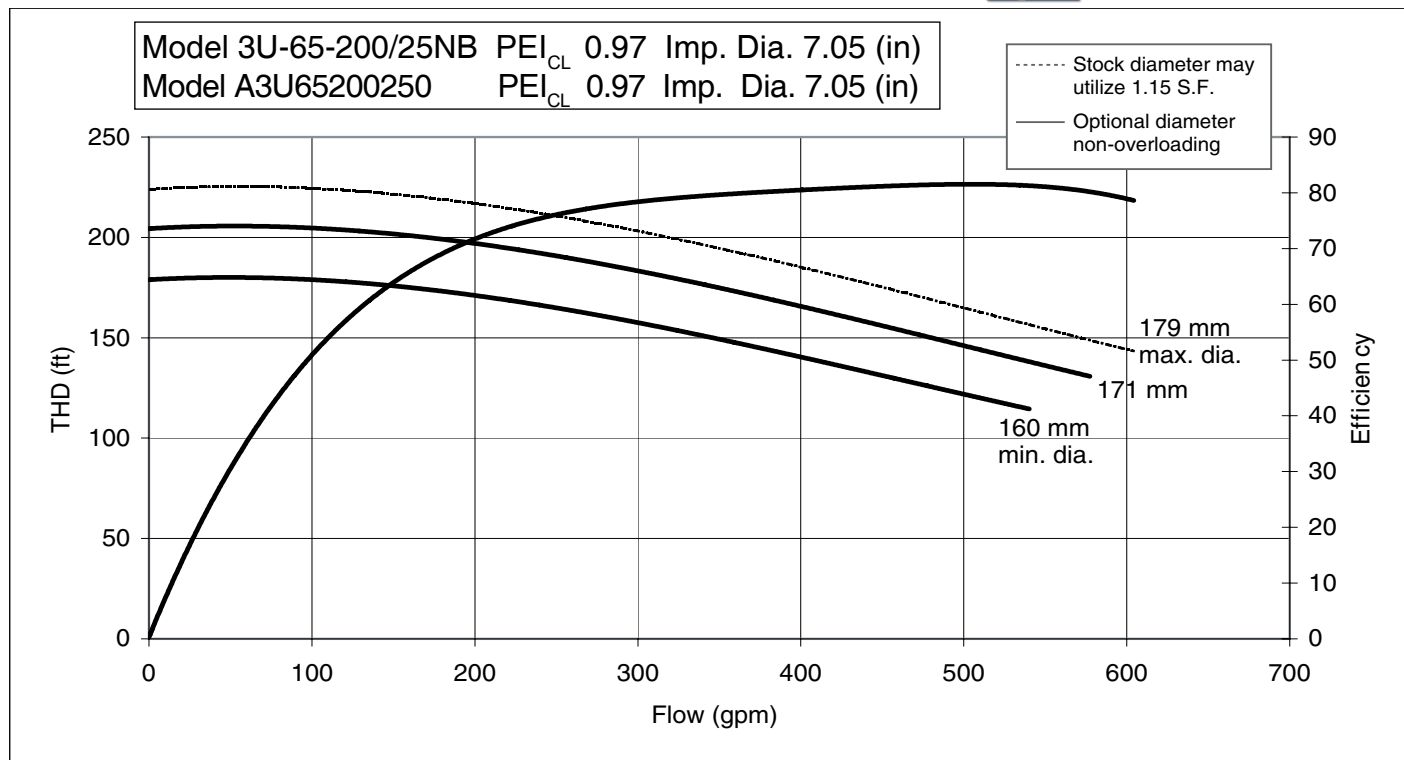

EBARA Stainless Steel Centrifugal Pumps

Model 3U

Performance Curves

3U 65-200-30HP

Nominal Speed: 3450 RPM

Size: 2½ x 3 x 7½ (190 mm)

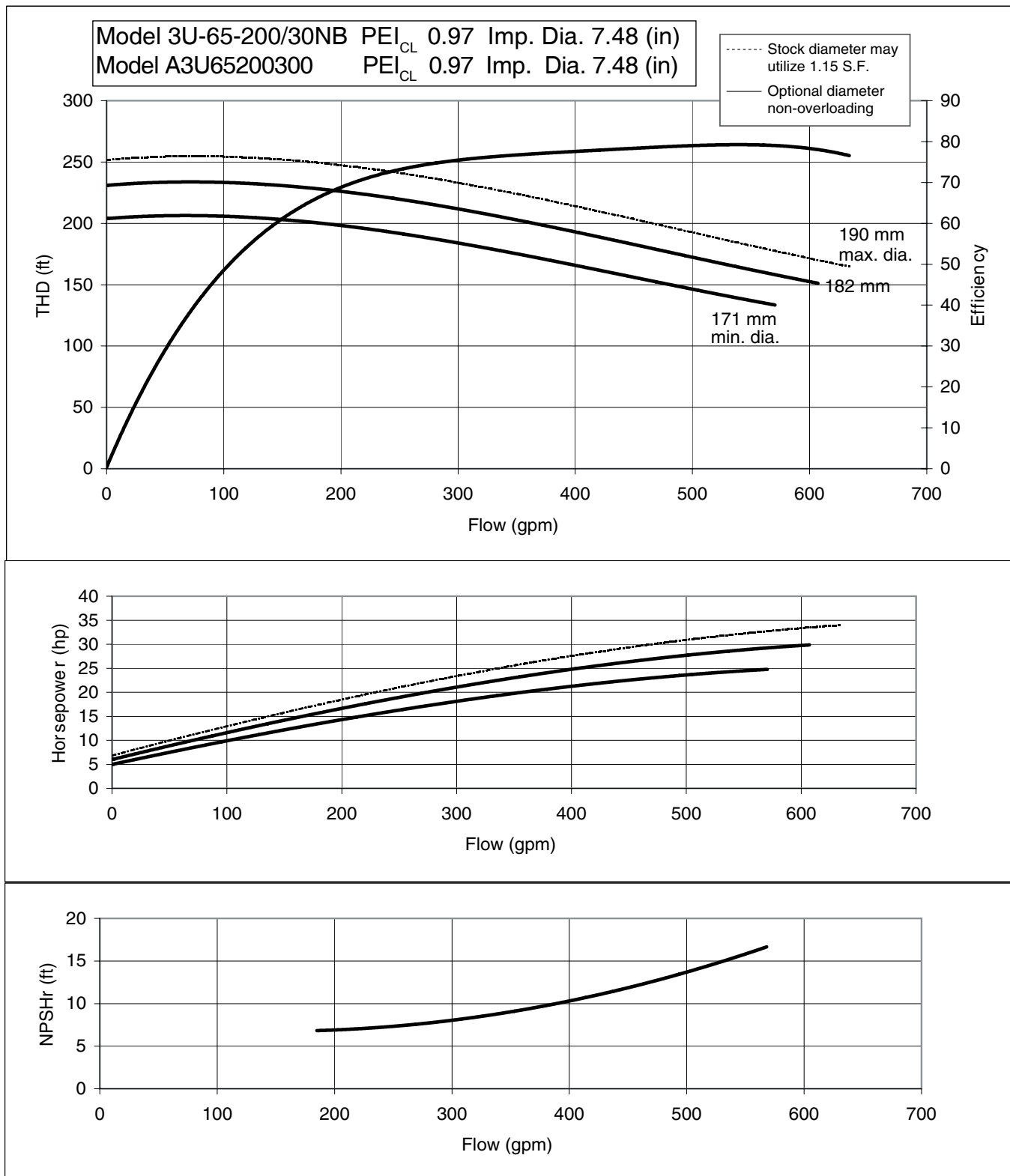

EBARA Stainless Steel Centrifugal Pumps

Model 3U

Selection Chart

Nominal Speed 1725 PM

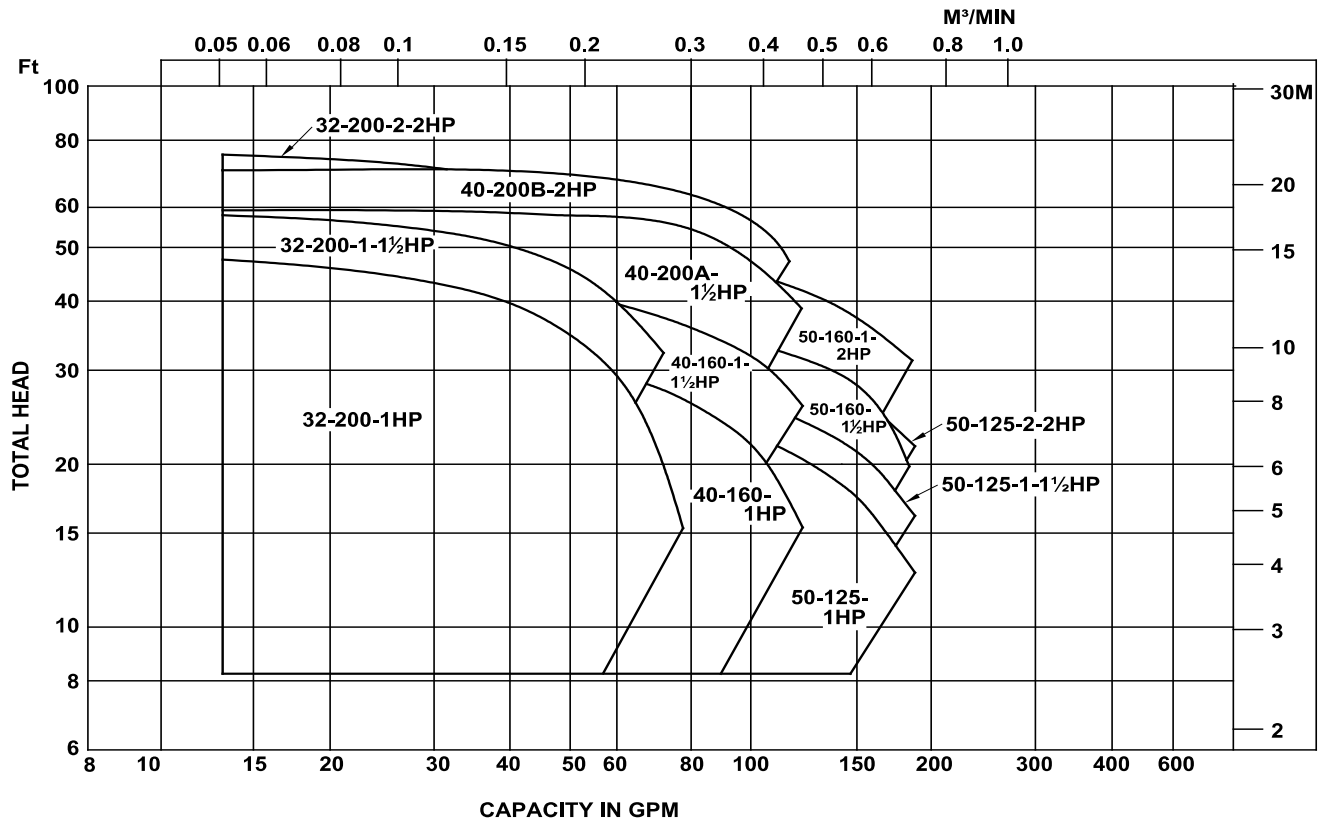

Illinois Location:
 (847) 841-7867
 860 Church Rd Elgin, IL 60120

Minnesota Location:
 (651) 758-7867
 330 Mill Bay South Suite 100
 Afton, MN 55001

PumpSupplyInc.com

PUMP SUPPLY
INCORPORATED



EBARA Stainless Steel Centrifugal Pumps

Model 3U

Performance Curves

3U4 32-200-1HP

Nominal Speed: 1725 RPM

Size: 1¼ x 2 x 7½₁₆

Model 3U4-32-200NB PEI_{CL} 0.96 Imp. Dia. 7.32 (in)
 Model A3U43220010 PEI_{CL} 0.96 Imp. Dia. 7.32 (in)

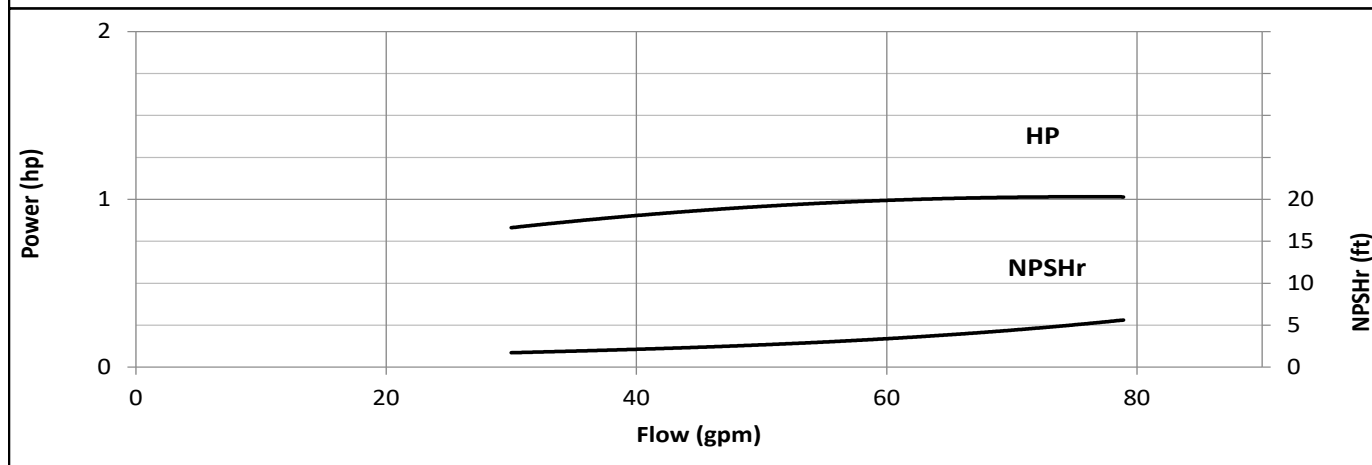
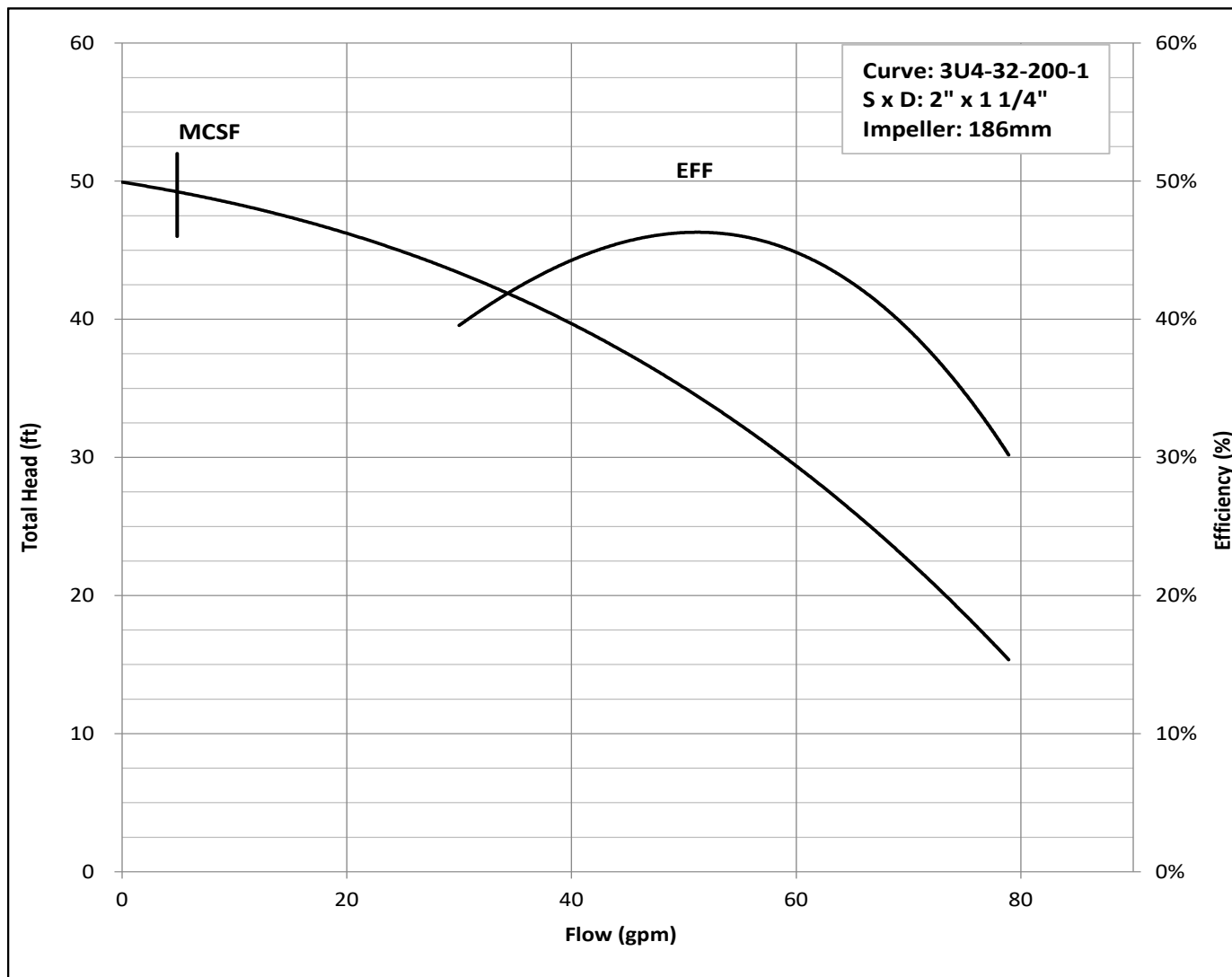

EBARA Stainless Steel Centrifugal Pumps

Model 3U

Performance Curves

3U4 32-200-1-1½HP

Nominal Speed: 1725 RPM

Size: 1¼ x 2 x 7⅞

Model 3U4-32-200-1NB PEI_{CL} 0.96 Imp. Dia. 7.87 (in)
 Model A3U432200115 PEI_{CL} 0.96 Imp. Dia. 7.87 (in)

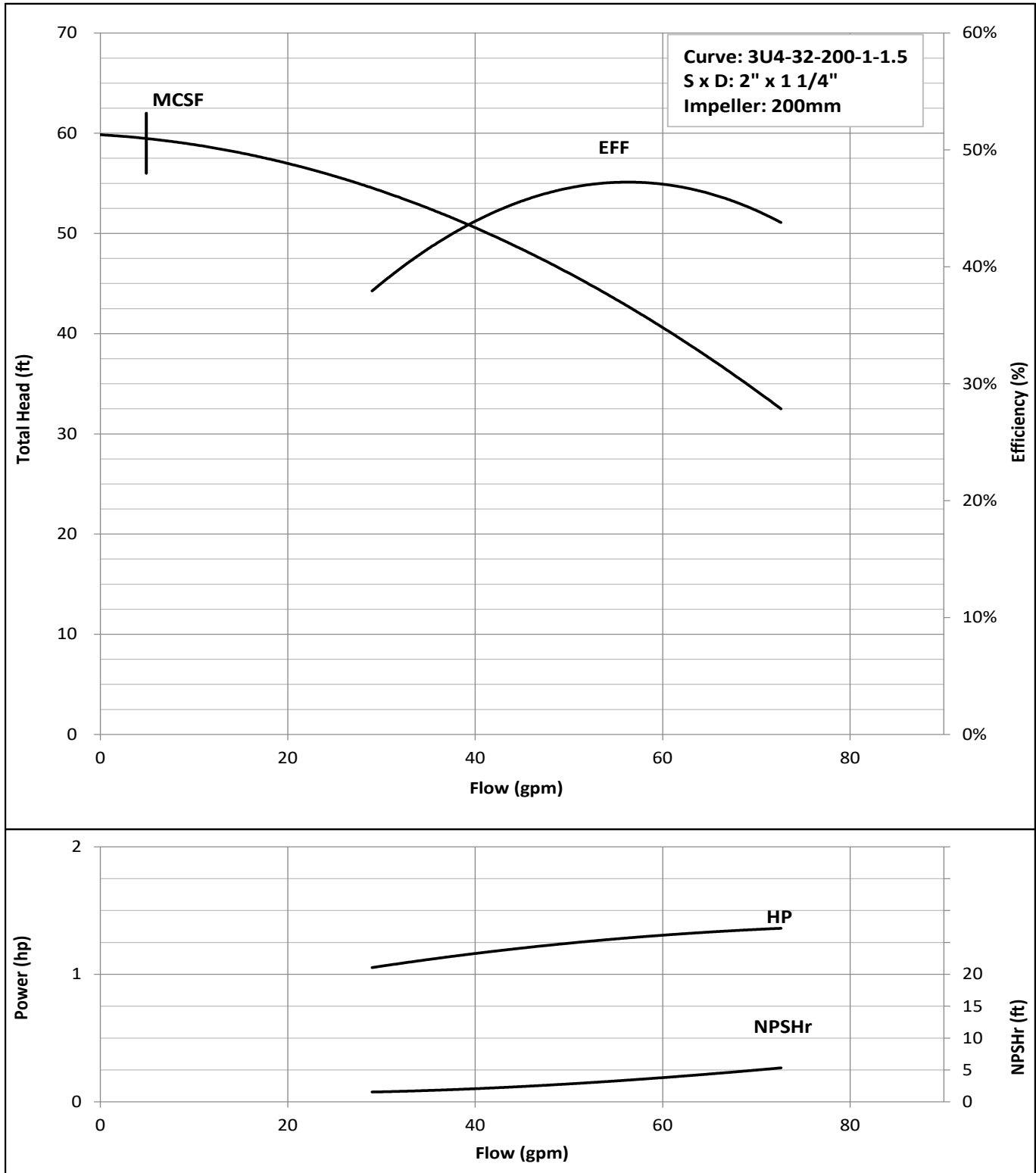

EBARA Stainless Steel Centrifugal Pumps

Model 3U

Performance Curves

3U4 32-200-2-2HP

Nominal Speed: 1725 RPM

Size: 1 1/4 x 2 x 8 13/16

Model 3U4-32-200-2NB PEI_{CL} 0.96 Imp. Dia. 8.82 (in)
 Model A3U432200220 PEI_{CL} 0.96 Imp. Dia. 8.82 (in)

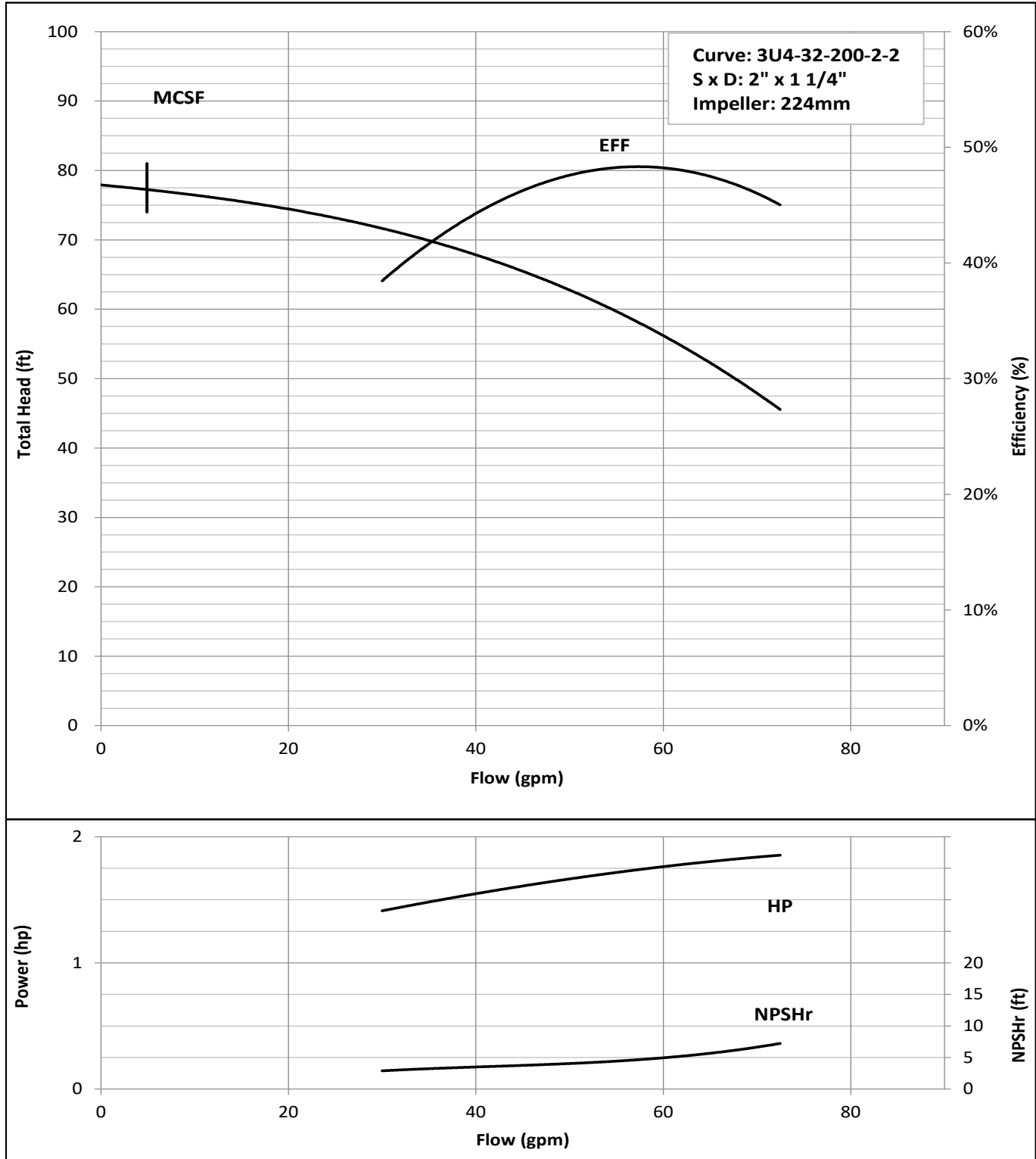

EBARA Stainless Steel Centrifugal Pumps

Model 3U

Performance Curves

3U4 40-160-1HP

Nominal Speed: 1725 RPM

Size: 1½ x 2½ x 5¹⁵/₁₆

Model 3U4-40-160NB PEI_{CL} 0.95 Imp. Dia. 5.94 (in)
 Model A3U44016010 PEI_{CL} 0.95 Imp. Dia. 5.94 (in)

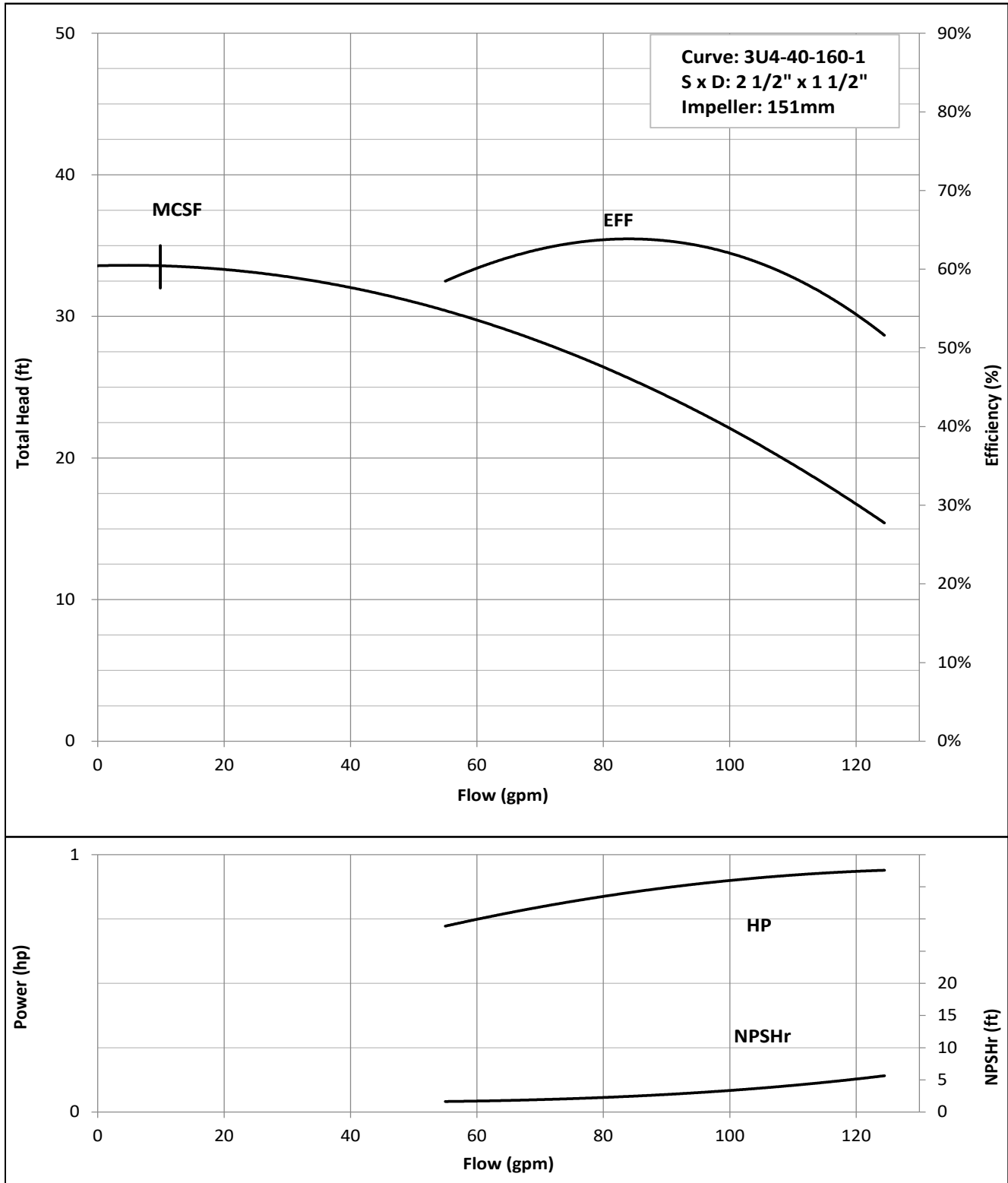

EBARA Stainless Steel Centrifugal Pumps

Model 3U

Performance Curves

3U4 40-160-1-1½HP

Nominal Speed: 1725 RPM

Size: 1½ x 2½ x 6½

Model 3U4-40-160-1NB	PEI _{CL}	0.95	Imp. Dia. 6.54 (in)
Model A3U440160115	PEI _{CL}	0.95	Imp. Dia. 6.54 (in)

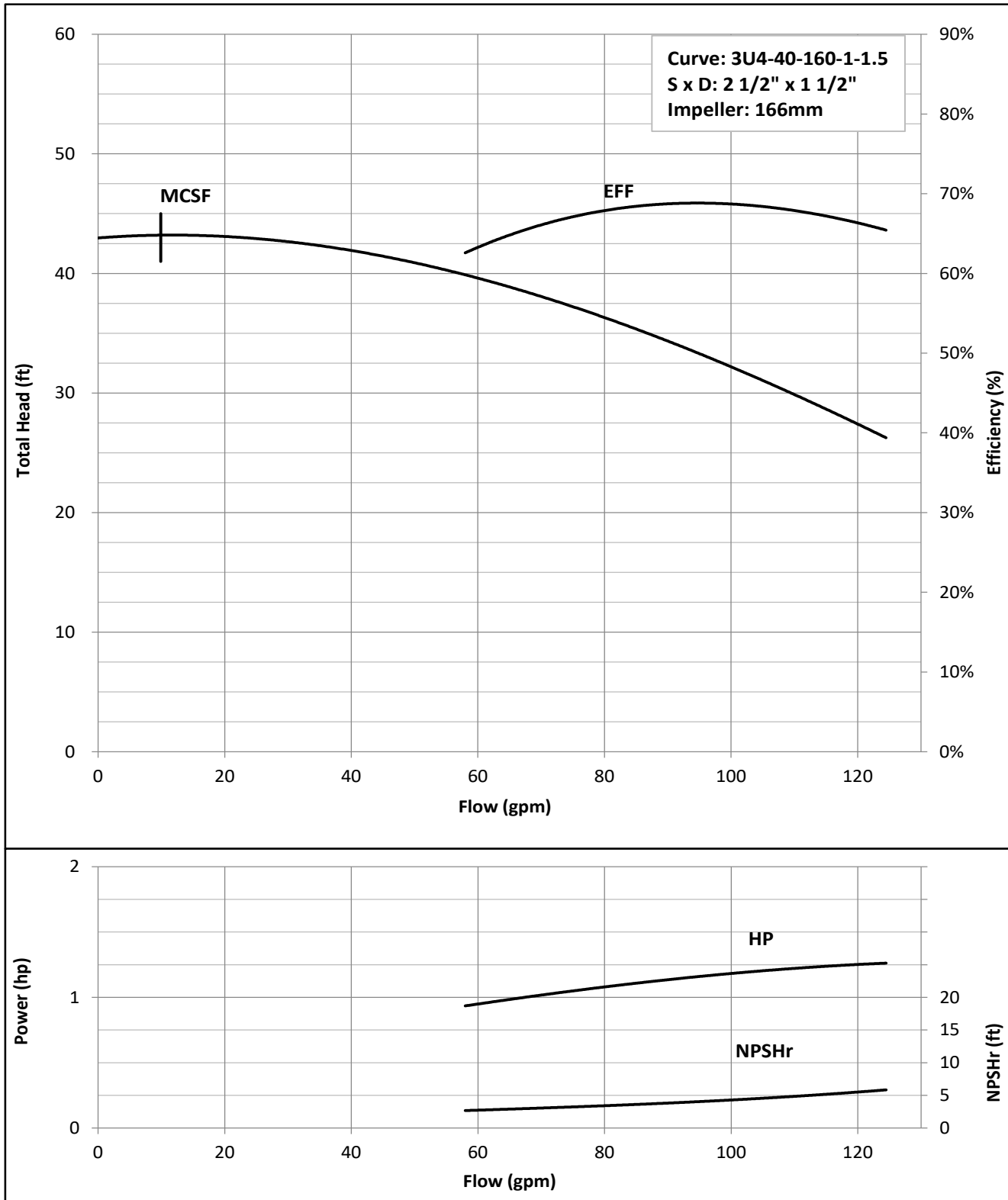

EBARA Stainless Steel Centrifugal Pumps

Model 3U

Performance Curves

3U4 40-200A-1½HP

Nominal Speed: 1725 RPM

Size: 1½ x 2½ x 7¾

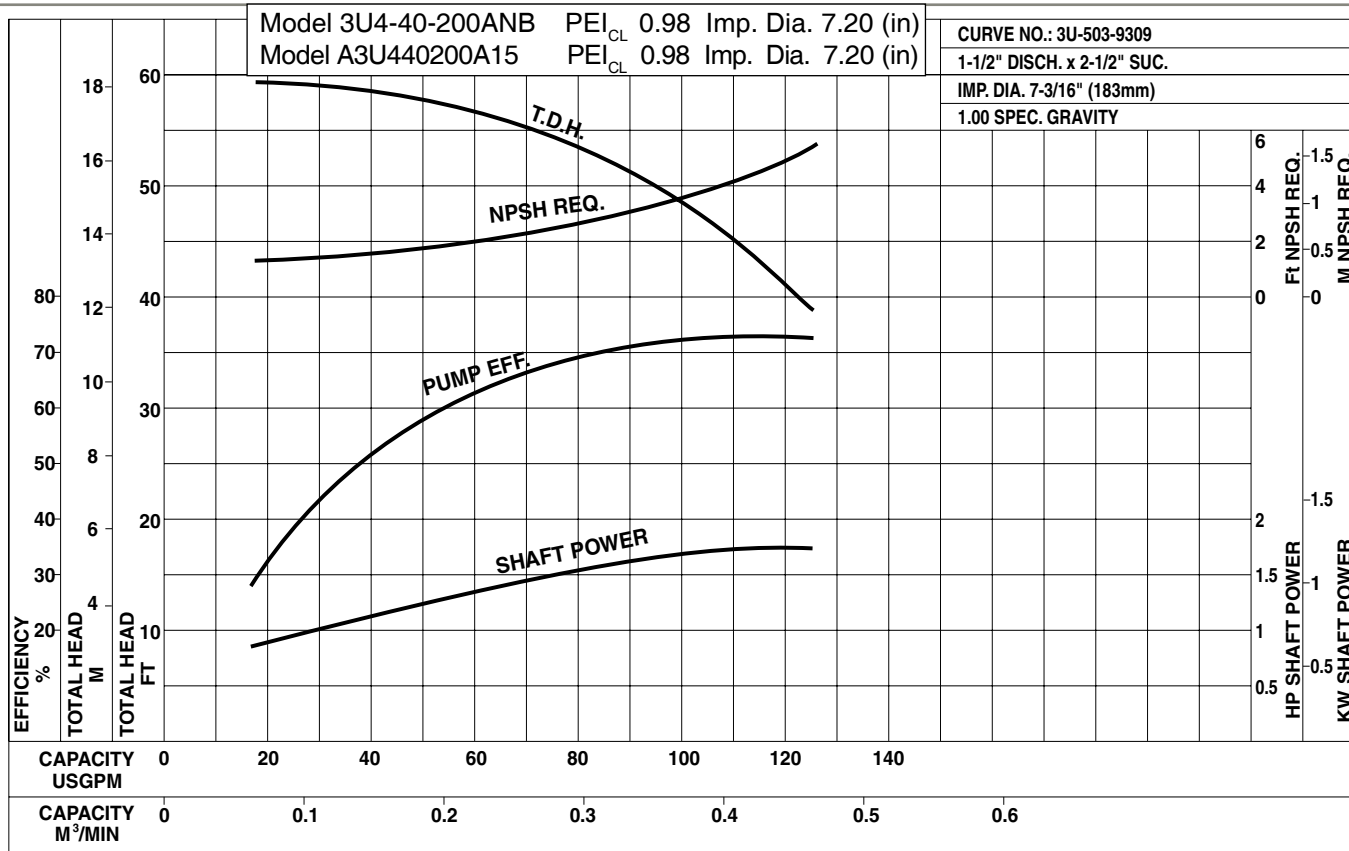

3U4 40-200B-2HP

Nominal Speed: 1725 RPM

Size: 1½ x 2½ x 7¾

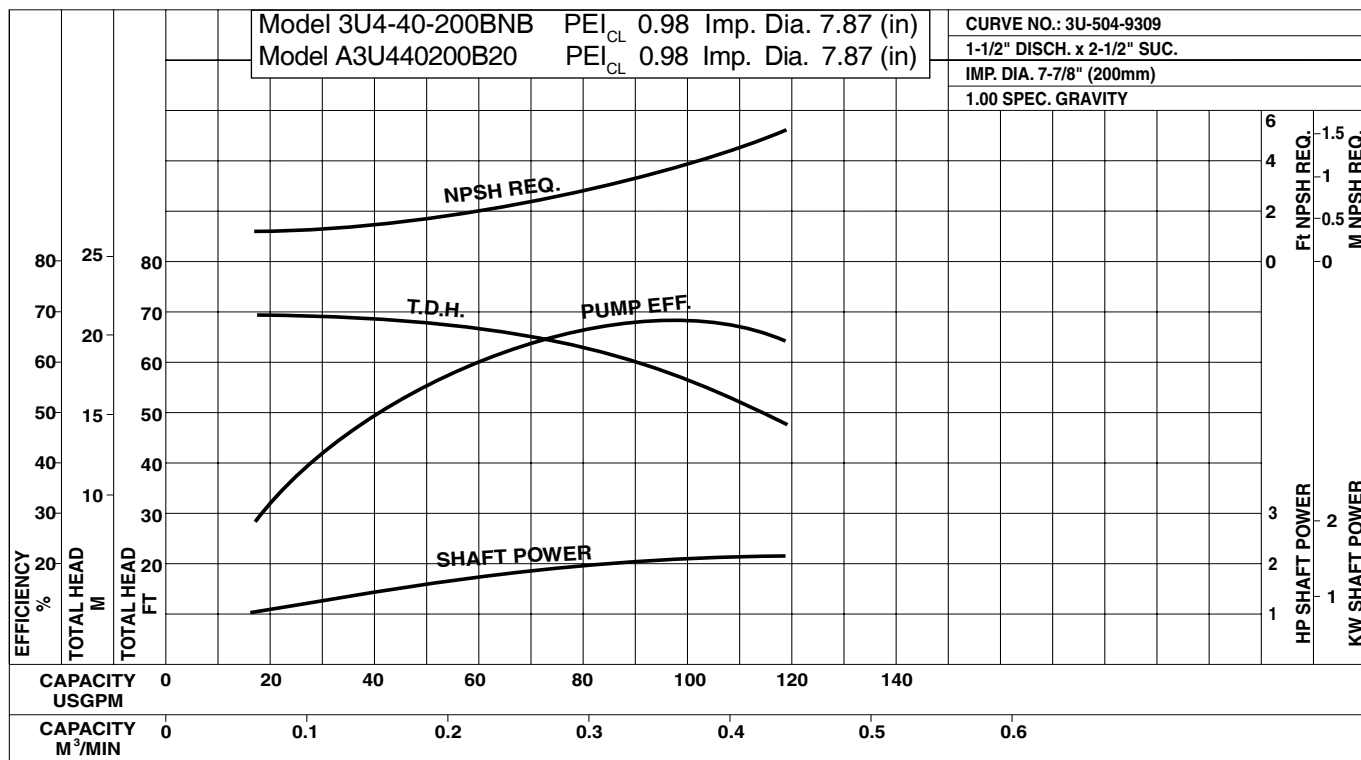

EBARA Stainless Steel Centrifugal Pumps

Model 3U

Performance Curves

3U4 50-125-1HP

Nominal Speed: 1725 RPM

Size: 2 x 2½ x 5³/₁₆

Model 3U4-50-125NB PEI_{CL} 0.99 Imp. Dia. 5.16 (in)
 Model A3U45012510 PEI_{CL} 0.99 Imp. Dia. 5.16 (in)

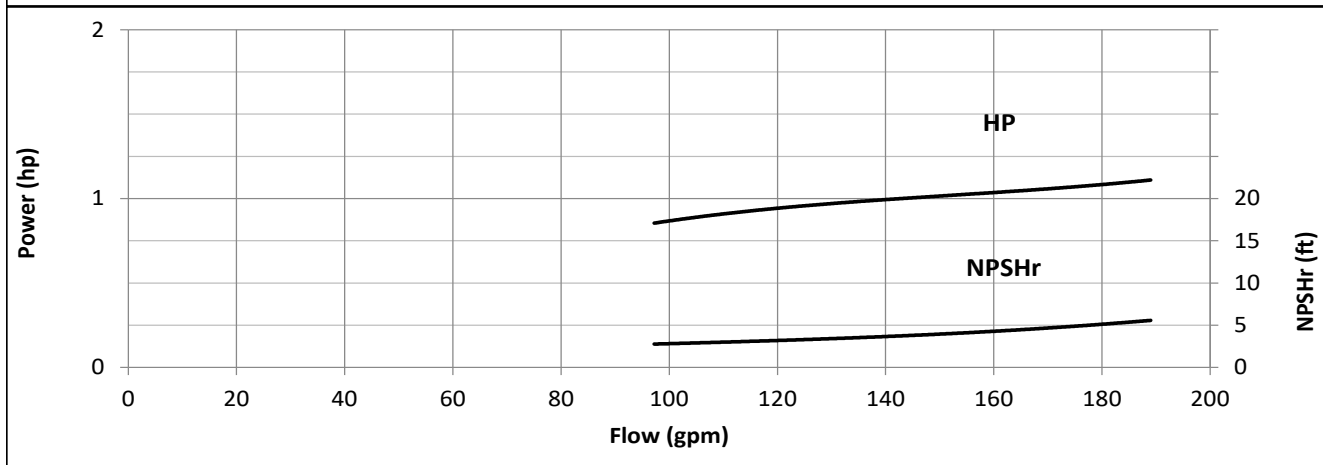
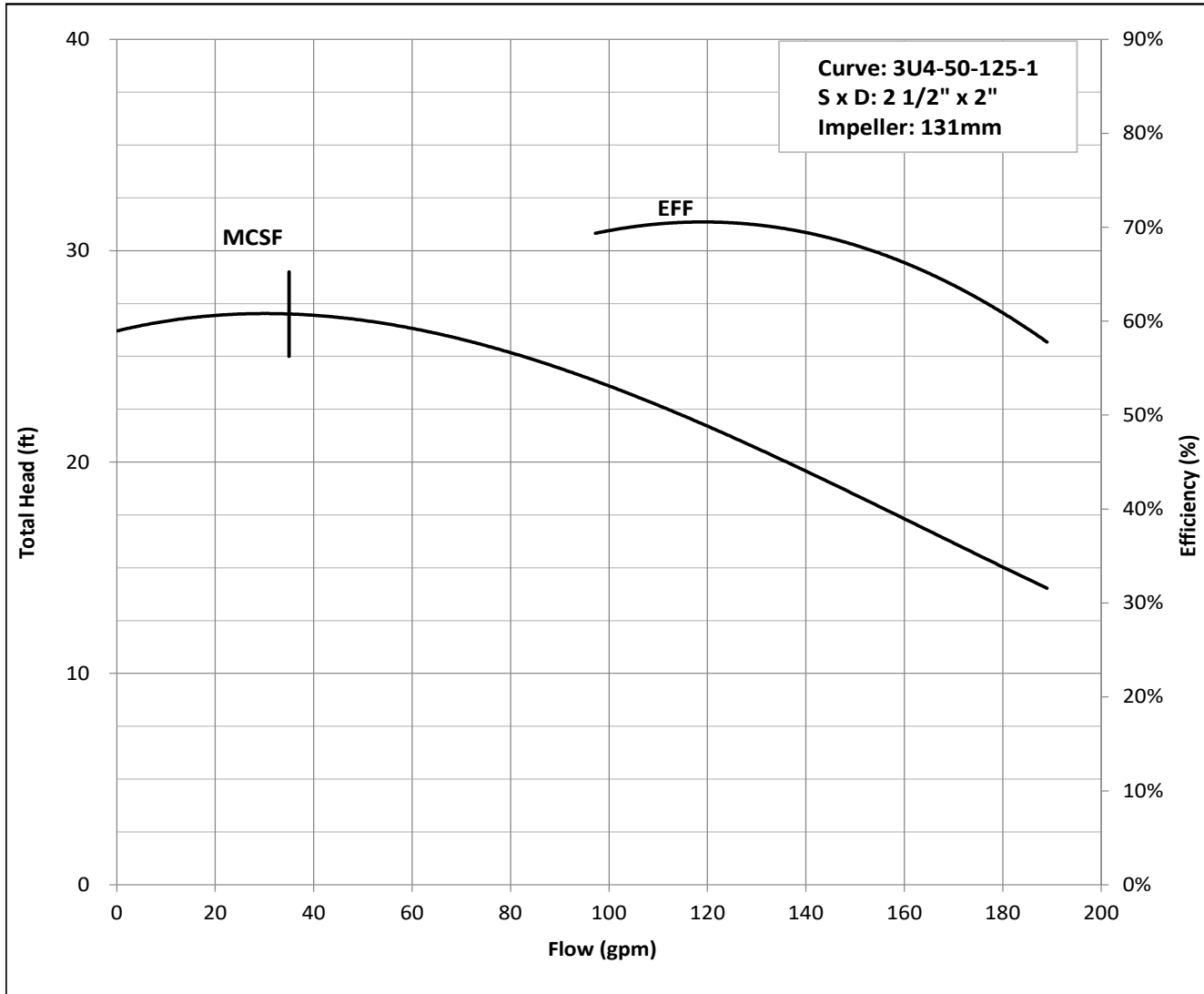

EBARA Stainless Steel Centrifugal Pumps

Model 3U

Performance Curves

3U4 50-125-1-1½HP

Nominal Speed: 1725 RPM

Size: 2 x 2½ x 5½

Model 3U4-50-125-1NB	PEI _{CL} 0.99	Imp. Dia. 5.51 (in)
Model A3U450125115	PEI _{CL} 0.99	Imp. Dia. 5.51 (in)

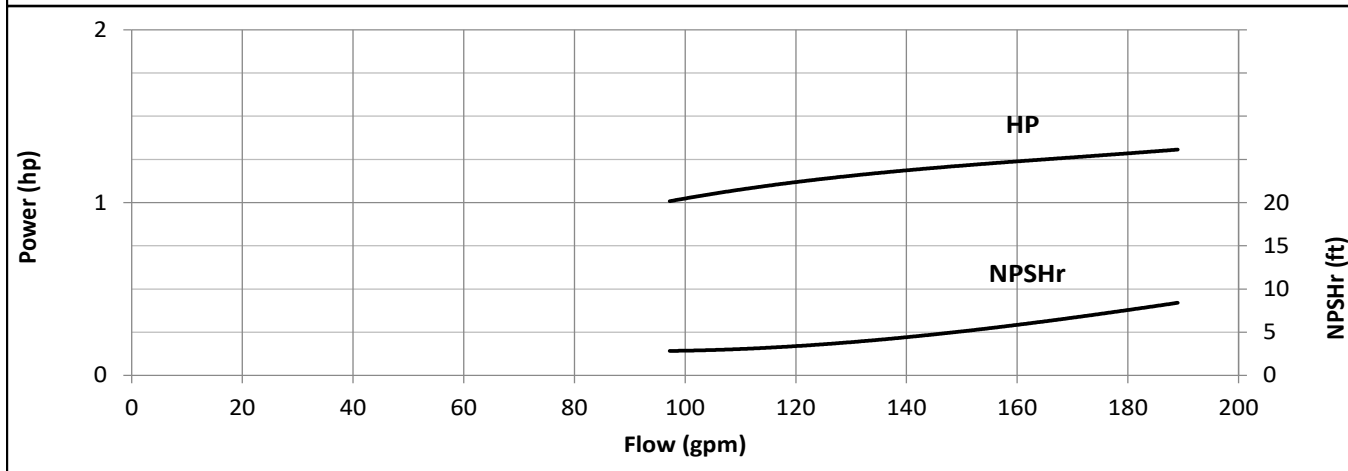
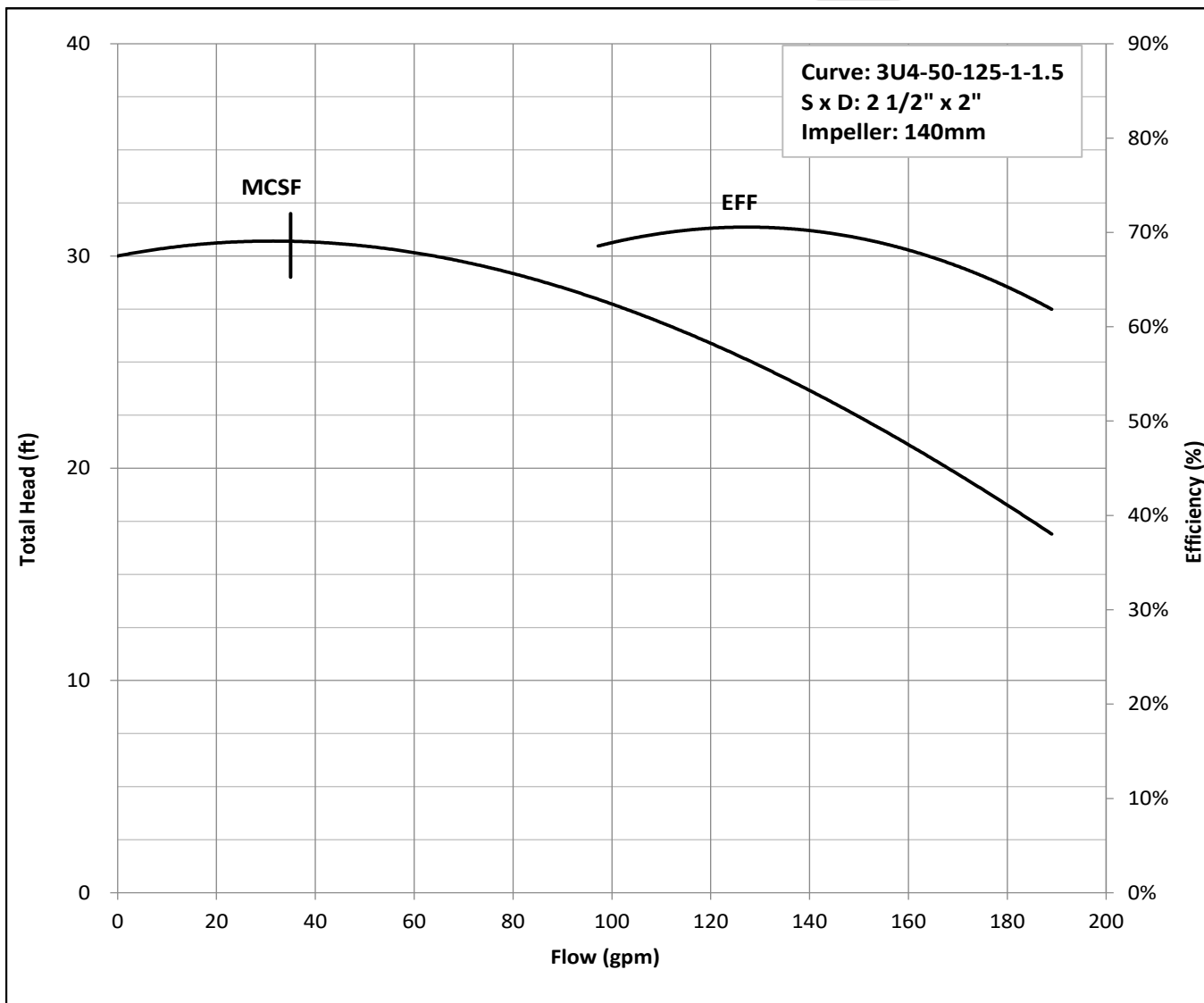

EBARA Stainless Steel Centrifugal Pumps

Model 3U

Performance Curves

3U4 50-125-2-2HP

Nominal Speed: 1725 RPM

Size: 2 x 2 1/2 x 5 15/16

Model 3U4-50-125-2NB	PEI _{CL}	0.99	Imp. Dia. 5.94 (in)
Model A3U450125220	PEI _{CL}	0.99	Imp. Dia. 5.94 (in)

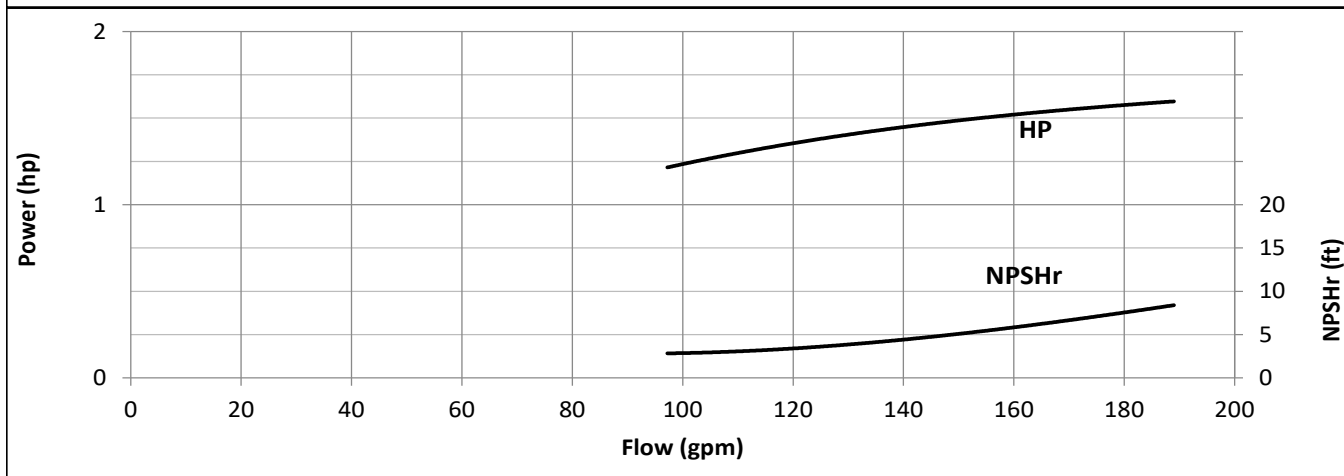
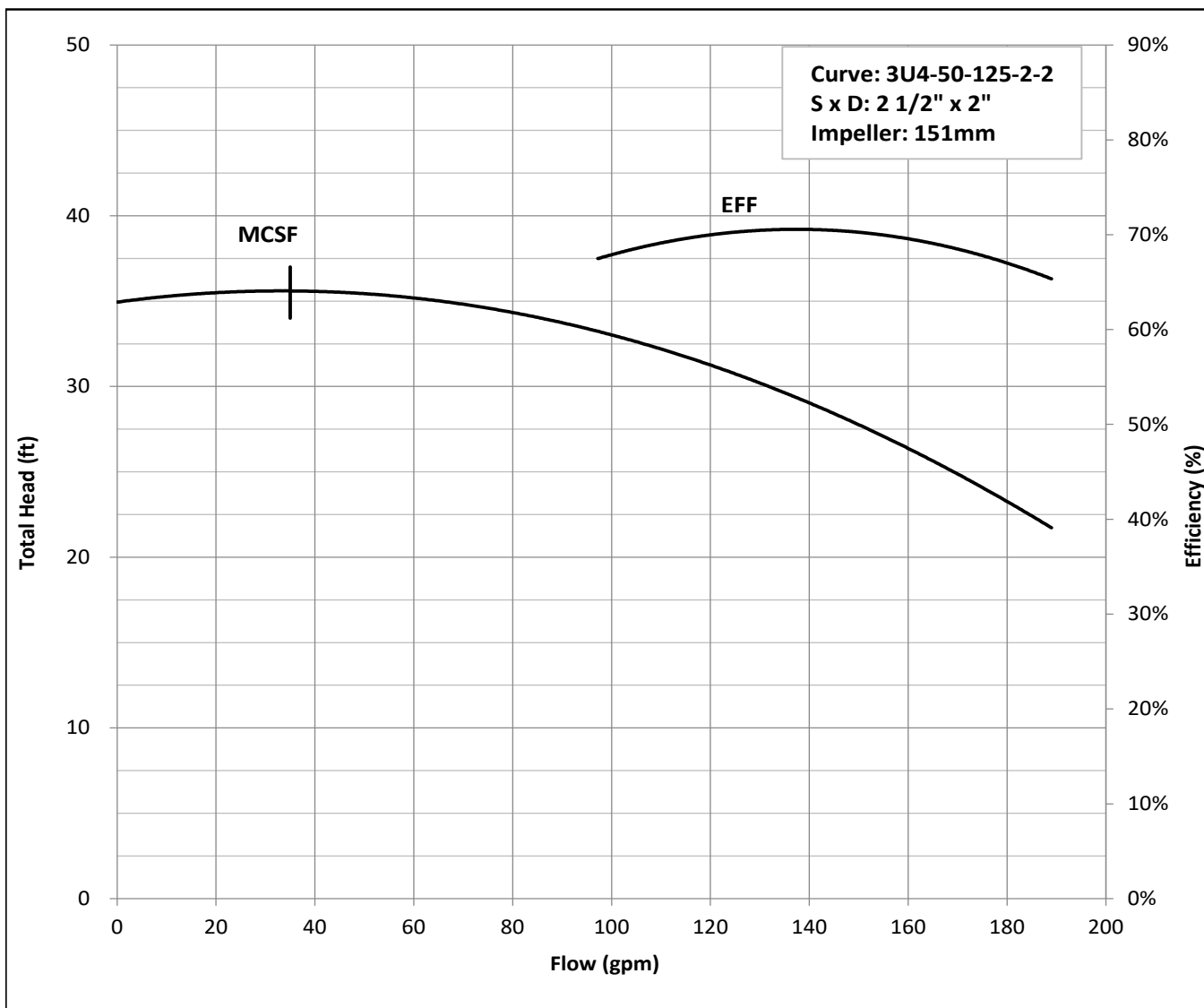

EBARA Stainless Steel Centrifugal Pumps

Model 3U

Performance Curves

3U4 50-160-1½HP

Nominal Speed: 1725 RPM

Size: 2 x 2½ x 6¹⁄₁₆

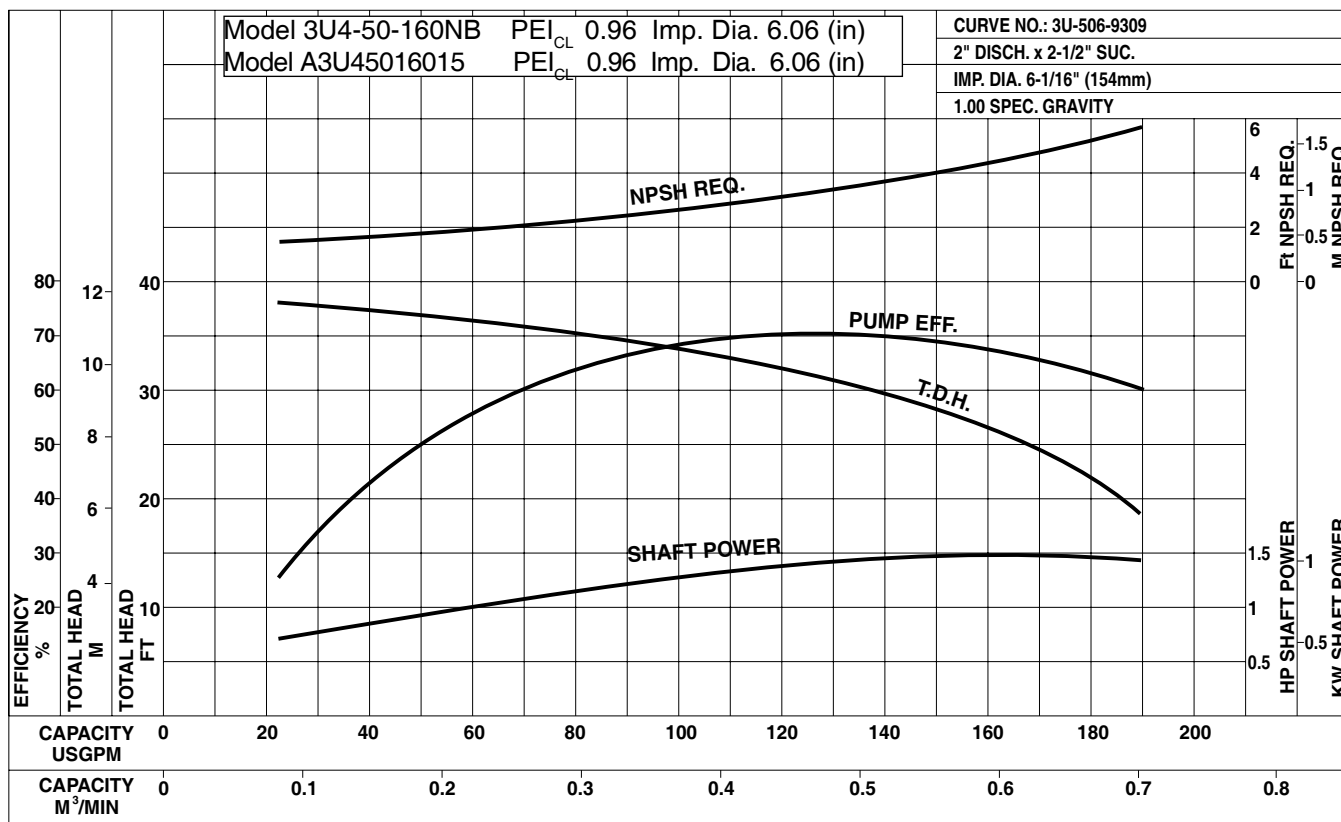

3U4 50-160-1-2HP

Nominal Speed: 1725 RPM

Size: 2 x 2½ x 6⁹⁄₁₆

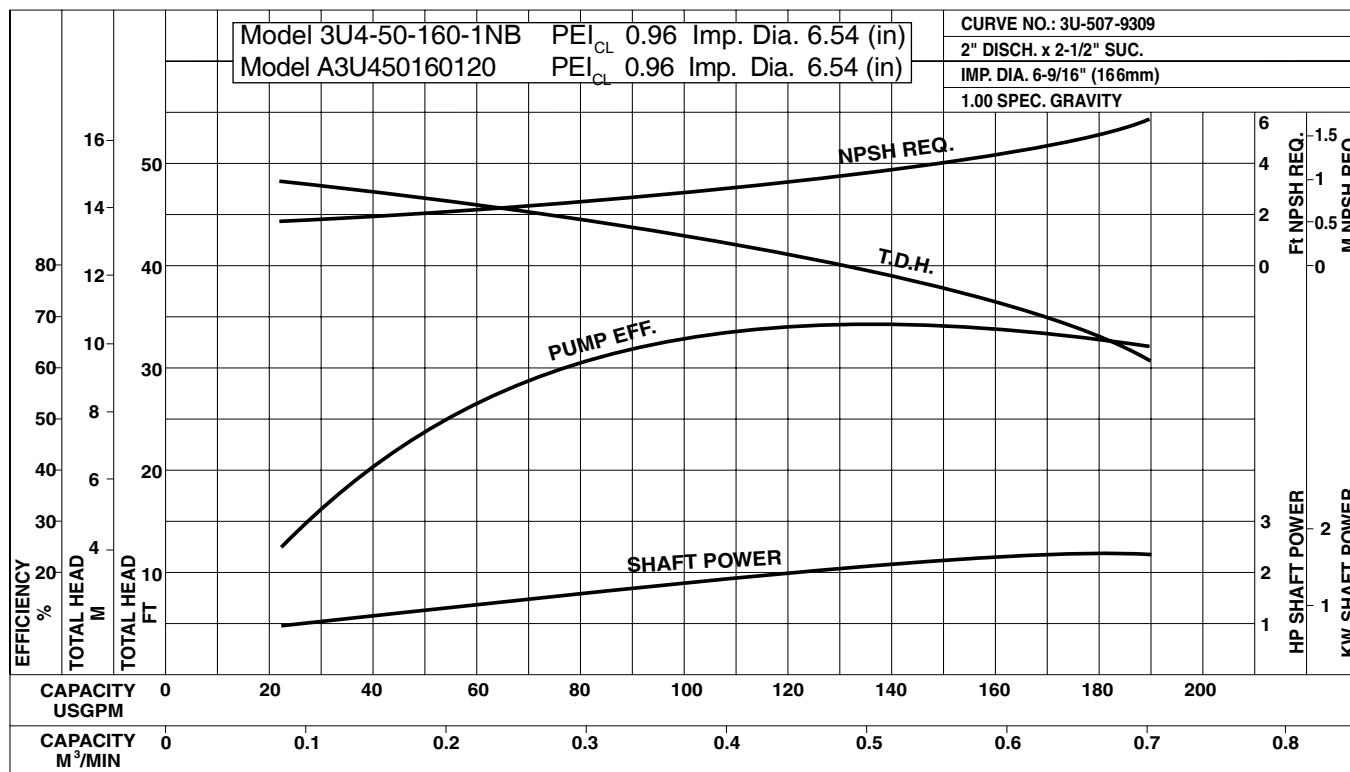

EBARA Stainless Steel Centrifugal Pumps

Model 3U

Pump Dimensions

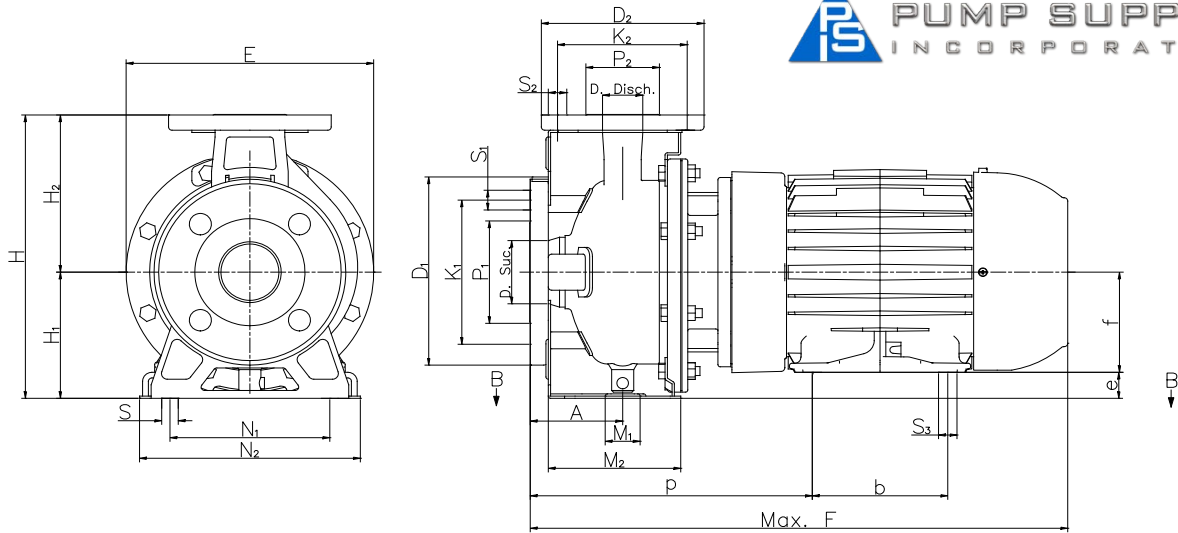

Unit: inch

Model	Size	Flange										Pump									
		Suction					Discharge														
		D Suc.	P ₁	K ₁	D ₁	S ₁	D Disch.	P ₂	K ₂	D ₂	S ₂	A	E	H	H ₁	H ₂	M ₁	M ₂	N ₁	N ₂	S
32-125-3HP	1 1/4 x 2 x 5 1/16	2	3 3/4	4 1 1/16	6 1/2	1 1/16	1 1/4	2 1/2	3 1/2	5 1/2	3 3/8	8 3/8	9 1 1/16	4 7/16	5 1/2	2 3/4	4 1/2	5 1/2	7 1/2	9 1/16	3/16
32-160A-5HP	1 1/4 x 2 x 5 1/16	2	3 3/4	4 1 1/16	6 1/2	1 1/16	1 1/4	2 1/2	3 1/2	5 1/2	3 3/8	10	11 1/2	5 3/16	6 5/16	2 3/4	4 3/8	7 1/2	9 1/16	3/16	
32-160B-5HP	1 1/4 x 2 x 6 1/16	2	3 3/4	4 1 1/16	6 1/2	1 1/16	1 1/4	2 1/2	3 1/2	5 1/2	3 3/8	10	11 1/2	5 3/16	6 5/16	2 3/4	4 3/8	7 1/2	9 1/16	3/16	
32-200-7 1/2HP	1 1/4 x 2 x 7 1/16	2	3 3/4	4 1 1/16	6 1/2	1 1/16	1 1/4	2 1/2	3 1/2	5 1/2	3 3/8	11 1/16	13 3/8	6 3/16	7 1/2	2 3/4	4 1 1/16	7 1/2	9 1/16	3/16	
32-200-10HP	1 1/4 x 2 x 7 7/16	2	3 3/4	4 1 1/16	6 1/2	1 1/16	1 1/4	2 1/2	3 1/2	5 1/2	3 3/8	11 1/16	13 3/8	6 3/16	7 1/2	2 3/4	4 1 1/16	7 1/2	9 1/16	3/16	
40-125A-5HP	1 1/2 x 2 1/2 x 4 1 1/16	2 1/2	4 3/8	5 1 1/16	7 3/8	1 1/16	1 1/2	2 1/8	3 3/8	5 3/8	3 3/8	8 3/8	9 1 1/16	4 7/16	5 1/2	2 3/4	4 1/2	6 3/8	8 1/4	3/16	
40-125B-5HP	1 1/2 x 2 1/2 x 5 1/2	2 1/2	4 3/8	5 1 1/16	7 3/8	1 1/16	1 1/2	2 1/8	3 3/8	5 3/8	3 3/8	8 3/8	9 1 1/16	4 7/16	5 1/2	2 3/4	4 1/2	6 3/8	8 1/4	3/16	
40-160-7 1/2HP	1 1/2 x 2 1/2 x 5 1 1/16	2 1/2	4 3/8	5 1 1/16	7 3/8	1 1/16	1 1/2	2 1/8	3 3/8	5 3/8	3 3/8	10	11 1/2	5 3/16	6 5/16	2 3/4	4 3/8	7 1/2	9 1/16	3/16	
40-160-1-10HP	1 1/2 x 2 1/2 x 6 1/16	2 1/2	4 3/8	5 1 1/16	7 3/8	1 1/16	1 1/2	2 1/8	3 3/8	5 3/8	3 3/8	10	11 1/2	5 3/16	6 5/16	2 3/4	4 3/8	7 1/2	9 1/16	3/16	
40-200A-15HP	1 1/2 x 2 1/2 x 7 1/16	2 1/2	4 3/8	5 1 1/16	7 3/8	1 1/16	1 1/2	2 1/8	3 3/8	5 3/8	3 3/8	11 1/16	13 3/8	6 3/16	7 1/2	2 3/4	4 1/2	8 3/8	10 1/16	3/16	
40-200B-15HP	1 1/2 x 2 1/2 x 7 7/16	2 1/2	4 3/8	5 1 1/16	7 3/8	1 1/16	1 1/2	2 1/8	3 3/8	5 3/8	3 3/8	11 1/16	13 3/8	6 3/16	7 1/2	2 3/4	4 1/2	8 3/8	10 1/16	3/16	
50-125-7 1/2HP	2 x 2 1/2 x 5 3/8	2 1/2	4 3/8	5 1 1/16	7 3/8	1 1/16	2	3 3/4	4 1 1/16	6 1/2	3 3/8	10	11 1/2	5 3/16	6 5/16	2 3/4	4 3/8	7 1/2	9 1/16	3/16	
50-125-10HP	2 x 2 1/2 x 5 1/2	2 1/2	4 3/8	5 1 1/16	7 3/8	1 1/16	2	3 3/4	4 1 1/16	6 1/2	3 3/8	10	11 1/2	5 3/16	6 5/16	2 3/4	4 3/8	7 1/2	9 1/16	3/16	
50-160-10HP	2 x 2 1/2 x 6 1/16	2 1/2	4 3/8	5 1 1/16	7 3/8	1 1/16	2	3 3/4	4 1 1/16	6 1/2	3 3/8	11 1/16	13 3/8	6 3/16	7 1/2	2 3/4	4 3/8	8 3/8	10 1/16	3/16	
50-160-1-15HP	2 x 2 1/2 x 6 1/16	2 1/2	4 3/8	5 1 1/16	7 3/8	1 1/16	2	3 3/4	4 1 1/16	6 1/2	3 3/8	11 1/16	13 3/8	6 3/16	7 1/2	2 3/4	4 3/8	8 3/8	10 1/16	3/16	



EBARA Stainless Steel Centrifugal Pumps

Model 3U

Pump Dimensions

3U 2-Pole Motor

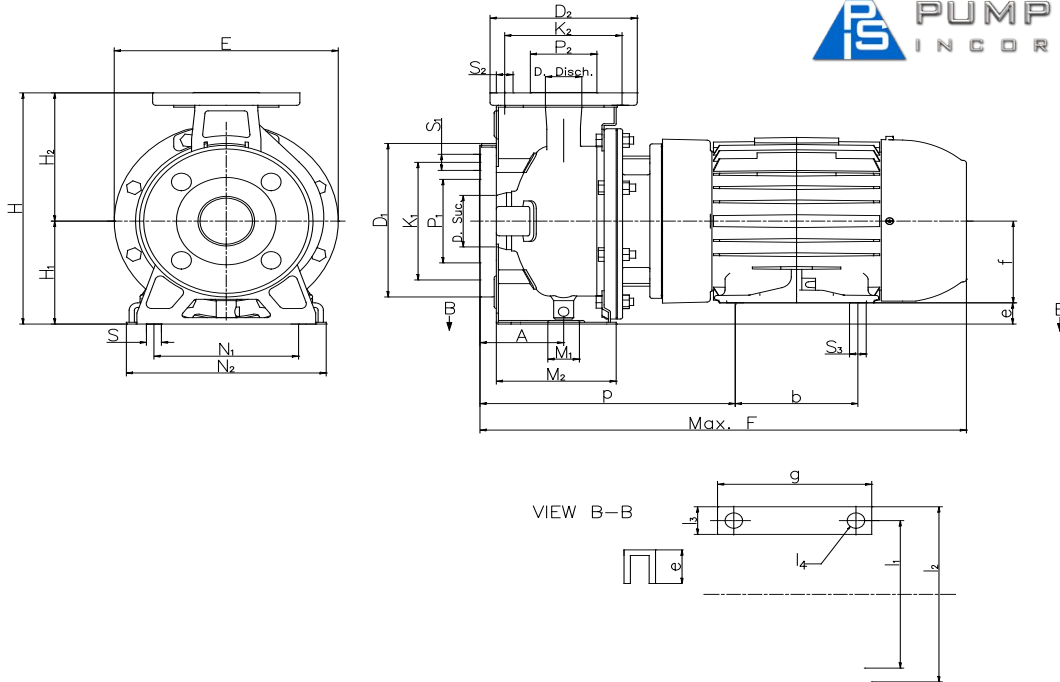

Unit: inch

Model	JM Frame	Motor									
		b	e	f	g	l ₁	l ₂	l ₃	P	S ₃	F
32-125	145JM	5	1 ⁵ / ₁₆	3 ¹ / ₂	5 ¹⁵ / ₁₆	5 ¹ / ₂	6 ¹ / ₂	1	6 ⁹ / ₁₆	1 ¹ / ₃₂	18 ¹⁵ / ₁₆
	182JM	4 ¹ / ₂	- ¹ / ₁₆	4 ¹ / ₂	6 ¹ / ₂	7 ¹ / ₂	8 ¹ / ₂	1	7 ³ / ₁₆	1 ³ / ₃₂	19 ³ / ₁₆
32-160A/B	182JM	4 ¹ / ₂	1 ¹ / ₁₆	4 ¹ / ₂	6 ¹ / ₂	7 ¹ / ₂	8 ¹ / ₂	1	7 ³ / ₁₆	1 ³ / ₃₂	19 ³ / ₁₆
	184JM	5 ¹ / ₂	1 ¹ / ₁₆	4 ¹ / ₂	6 ¹ / ₂	7 ¹ / ₂	8 ¹ / ₂	1	7 ³ / ₁₆	1 ³ / ₃₂	20 ⁵ / ₁₆
32-200	184JM	5 ¹ / ₂	1 ¹³ / ₁₆	4 ¹ / ₂	6 ¹ / ₂	7 ¹ / ₂	8 ¹ / ₂	1	7 ³ / ₁₆	1 ³ / ₃₂	22 ¹ / ₈
	213JM	5 ¹ / ₂	1 ¹ / ₁₆	5 ¹ / ₄	8	8 ¹ / ₂	9 ¹ / ₂	1	8 ³ / ₁₆	1 ³ / ₃₂	20 ³ / ₄
	215JM	7	1 ¹ / ₁₆	5 ¹ / ₄	8	8 ¹ / ₂	9 ¹ / ₂	1	8 ³ / ₁₆	1 ³ / ₃₂	21 ¹ / ₈
40-125A/B	182JM	4 ¹ / ₂	- ¹ / ₁₆	4 ¹ / ₂	6 ¹ / ₂	7 ¹ / ₂	8 ¹ / ₂	1	7 ³ / ₁₆	1 ³ / ₃₂	19 ³ / ₁₆
	184JM	5 ¹ / ₂	- ¹ / ₁₆	4 ¹ / ₂	6 ¹ / ₂	7 ¹ / ₂	8 ¹ / ₂	1	7 ³ / ₁₆	1 ³ / ₃₂	20 ³ / ₄
40-160	184JM	5 ¹ / ₂	1 ¹ / ₁₆	4 ¹ / ₂	6 ¹ / ₂	7 ¹ / ₂	8 ¹ / ₂	1	7 ³ / ₁₆	1 ³ / ₃₂	22 ¹ / ₈
	213JM	5 ¹ / ₂	- ¹ / ₁₆	5 ¹ / ₄	8	8 ¹ / ₂	9 ¹ / ₂	1	8 ³ / ₁₆	1 ³ / ₃₂	20 ³ / ₄
	215JM	7	- ¹ / ₁₆	5 ¹ / ₄	8	8 ¹ / ₂	9 ¹ / ₂	1	8 ³ / ₁₆	1 ³ / ₃₂	21 ¹ / ₈
40-200	215JM	7	1 ¹ / ₁₆	5 ¹ / ₄	8	8 ¹ / ₂	9 ¹ / ₂	1	8 ³ / ₁₆	1 ³ / ₃₂	22 ¹ / ₁₆
50-125	184JM	5 ¹ / ₂	1 ¹ / ₁₆	4 ¹ / ₂	6 ¹ / ₂	7 ¹ / ₂	8 ¹ / ₂	1	7 ³ / ₁₆	1 ³ / ₃₂	22 ¹⁵ / ₁₆
	213JM	5 ¹ / ₂	- ¹ / ₁₆	5 ¹ / ₄	8	8 ¹ / ₂	9 ¹ / ₂	1	8 ³ / ₁₆	1 ³ / ₃₂	21 ¹ / ₁₆
	215JM	7	- ¹ / ₁₆	5 ¹ / ₄	8	8 ¹ / ₂	9 ¹ / ₂	1	8 ³ / ₁₆	1 ³ / ₃₂	22 ¹ / ₁₆
50-160	213JM	5 ¹ / ₂	1 ¹ / ₁₆	5 ¹ / ₄	8	8 ¹ / ₂	9 ¹ / ₂	1	8 ³ / ₁₆	1 ³ / ₃₂	21 ¹ / ₁₆
	215JM	7	1 ¹ / ₁₆	5 ¹ / ₄	8	8 ¹ / ₂	9 ¹ / ₂	1	8 ³ / ₁₆	1 ³ / ₃₂	22 ¹ / ₁₆

Remarks:

1. "e" dimensions (-) means H₁ < f.
In this case, need distance piece under the pump.
2. "F" dimensions indicate maximum dimension.



EBARA Stainless Steel Centrifugal Pumps

Model 3U

Pump Dimensions

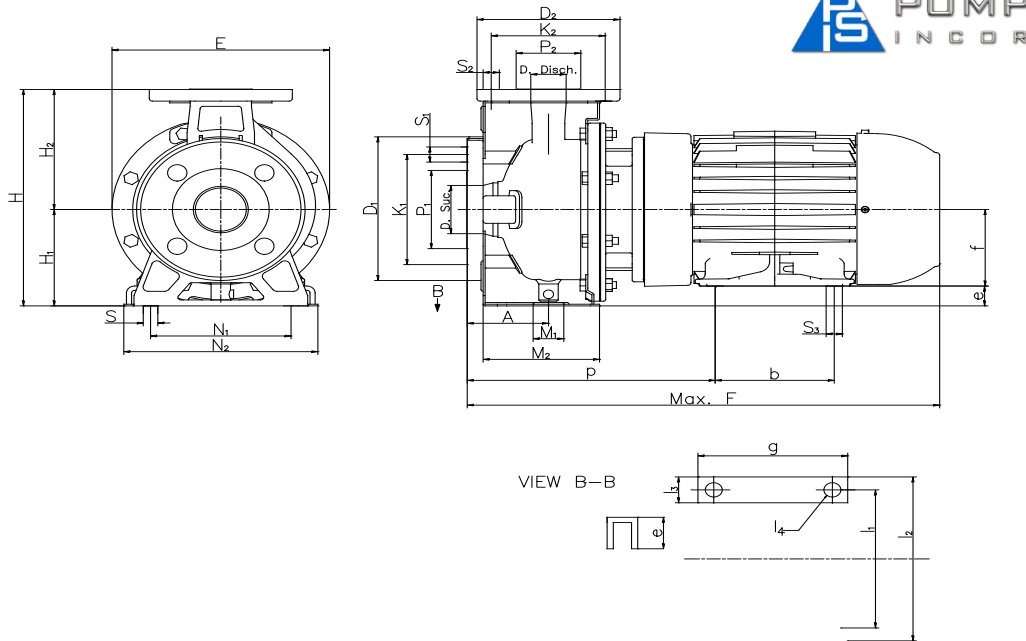

3U 4-Pole TEFC Motor

Model	HP	Phase	JM Frame	b	e	f	g	l1	l2	l3	l4	P	S3	F
32-200	1	3	143JM	5	2 13/16	3 1/2	5 15/16	5 1/2	7 1/2	1 3/4	5/16	9 1/16	3/8	19 13/16
	1	1	145JM	5	2 13/16	3 1/2	5 15/16	5 1/2	7 1/2	1 3/4	5/16	9 1/16	3/8	19 13/16
	1.5	3	145JM	5	2 13/16	3 1/2	5 15/16	5 1/2	7 1/2	1 3/4	5/16	9 1/16	3/8	19 5/8
	1.5	1	145JM	5	2 13/16	3 1/2	5 15/16	5 1/2	7 1/2	1 3/4	5/16	10 7/8	3/8	20 13/16
40-160	2	3	145JM	5	2 13/16	3 1/2	5 15/16	5 1/2	7 1/2	1 3/4	5/16	10 7/8	3/8	19 1/16
	1	1	145JM	5	2 13/16	3 1/2	5 15/16	5 1/2	7 1/2	1 3/4	5/16	7 9/16	3/8	19 13/16
	1	3	143JM	5	1 11/16	3 1/2	5 15/16	5 1/2	7 1/2	1 3/4	5/16	7 1/2	3/8	19 3/4
40-200A/B	1.5	3	145JM	5	1 3/4	3 1/2	5 15/16	5 1/2	7 1/2	1 3/4	5/16	10 7/8	3/8	18 11/16
	1.5	3	145JM	5	2 13/16	3 1/2	5 15/16	5 1/2	7 1/2	1 3/4	5/16	7 1/2	3/8	18 3/4
50-125	2	3	145JM	5	2 13/16	3 1/2	5 15/16	5 1/2	7 1/2	1 3/4	5/16	7 1/2	3/8	18 3/4
	1	3	143JM	5	1 11/16	3 1/2	5 15/16	5 1/2	7 1/2	1 3/4	5/16	7 1/2	3/8	19 5/8
	1.5	3	145JM	5	1 11/16	3 1/2	5 15/16	5 1/2	7 1/2	1 3/4	5/16	10 7/8	3/8	19 1/2
50-160	2	3	145JM	5	1 11/16	3 1/2	5 15/16	5 1/2	7 1/2	1 3/4	5/16	10 7/8	3/8	19 7/8
	1.5	1	145JM	5	2 13/16	3 1/2	5 15/16	5 1/2	7 1/2	1 3/4	5/16	10 1/2	3/8	20 13/16
	1.5	3	145JM	5	2 13/16	3 1/2	5 15/16	5 1/2	7 1/2	1 3/4	5/16	10 1/2	3/8	19 5/8
	2	3	145JM	5	2 13/16	3 1/2	5 15/16	5 1/2	7 1/2	1 3/4	5/16	10 1/2	3/8	19 5/8



EBARA Stainless Steel Centrifugal Pumps

Model 3U

Pump Dimensions

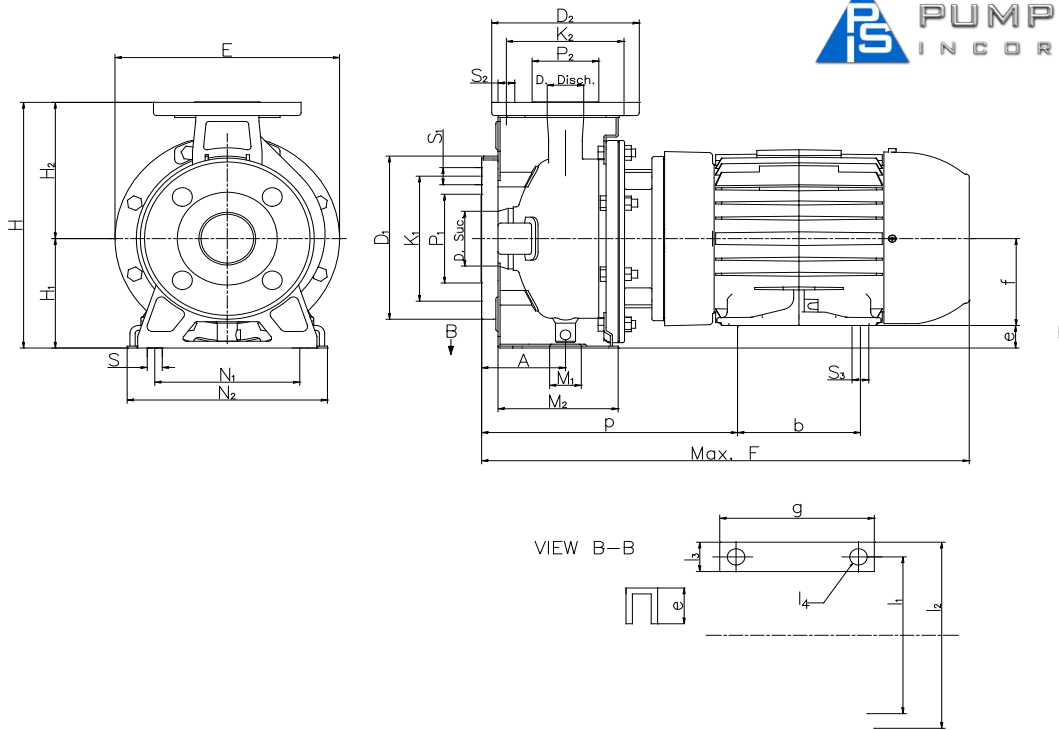

3U 4-Pole ODP Motor

Model	HP	Phase	JM Frame	b	e	f	g	I1	I2	I3	I4	P	S3	F
32-200	1	3	143JM	5	2 ¹³ / ₁₆	3 ¹ / ₂	5 ¹⁵ / ₁₆	5 ¹ / ₂	7 ¹ / ₂	1 ³ / ₄	5 ¹ / ₁₆	7 ⁹ / ₁₆	3 ³ / ₈	18 ¹⁵ / ₁₆
	1.5	3	145JM	5	2 ¹³ / ₁₆	3 ¹ / ₂	5 ¹⁵ / ₁₆	5 ¹ / ₂	7 ¹ / ₂	1 ³ / ₄	5 ¹ / ₁₆	7 ⁹ / ₁₆	3 ³ / ₈	18 ¹⁵ / ₁₆
	2	3	145JM	5	2 ¹³ / ₁₆	3 ¹ / ₂	5 ¹⁵ / ₁₆	5 ¹ / ₂	7 ¹ / ₂	1 ³ / ₄	5 ¹ / ₁₆	10 ¹ / ₁₆	3 ³ / ₈	17 ⁷ / ₁₆
40-160	1	3	143JM	5	1 ¹¹ / ₁₆	3 ¹ / ₂	5 ¹⁵ / ₁₆	5 ¹ / ₂	7 ¹ / ₂	1 ³ / ₄	5 ¹ / ₁₆	7 ¹ / ₂	3 ³ / ₈	18 ³ / ₈
	1.5	3	145JM	5	1 ¹¹ / ₁₆	3 ¹ / ₂	5 ¹⁵ / ₁₆	5 ¹ / ₂	7 ¹ / ₂	1 ³ / ₄	5 ¹ / ₁₆	10 ¹ / ₁₆	3 ³ / ₈	17 ⁷ / ₁₆
40-200A/B	1.5	3	145JM	5	2 ¹³ / ₁₆	3 ¹ / ₂	5 ¹⁵ / ₁₆	5 ¹ / ₂	7 ¹ / ₂	1 ³ / ₄	5 ¹ / ₁₆	7 ³ / ₈	3 ³ / ₈	19 ⁵ / ₈
	2	3	145JM	5	2 ¹³ / ₁₆	3 ¹ / ₂	5 ¹⁵ / ₁₆	5 ¹ / ₂	7 ¹ / ₂	1 ³ / ₄	5 ¹ / ₁₆	7 ³ / ₈	3 ³ / ₈	19 ⁵ / ₈
50-125	1	3	143JM	5	1 ¹¹ / ₁₆	3 ¹ / ₂	5 ¹⁵ / ₁₆	5 ¹ / ₂	7 ¹ / ₂	1 ³ / ₄	5 ¹ / ₁₆	7 ³ / ₈	3 ³ / ₈	18 ³ / ₄
	1.5	3	145JM	5	1 ¹¹ / ₁₆	3 ¹ / ₂	5 ¹⁵ / ₁₆	5 ¹ / ₂	7 ¹ / ₂	1 ³ / ₄	5 ¹ / ₁₆	10 ¹ / ₁₆	3 ³ / ₈	18 ¹ / ₄
	2	3	145JM	5	1 ¹¹ / ₁₆	3 ¹ / ₂	5 ¹⁵ / ₁₆	5 ¹ / ₂	7 ¹ / ₂	1 ³ / ₄	5 ¹ / ₁₆	10 ¹ / ₁₆	3 ³ / ₈	18 ¹ / ₄
50-160	1.5	3	145JM	5	2 ¹³ / ₁₆	3 ¹ / ₂	5 ¹⁵ / ₁₆	5 ¹ / ₂	7 ¹ / ₂	1 ³ / ₄	5 ¹ / ₁₆	10 ¹ / ₁₆	3 ³ / ₈	17 ¹ / ₈
	2	3	145JM	5	2 ¹³ / ₁₆	3 ¹ / ₂	5 ¹⁵ / ₁₆	5 ¹ / ₂	7 ¹ / ₂	1 ³ / ₄	5 ¹ / ₁₆	10 ¹ / ₁₆	3 ³ / ₈	17 ¹ / ₈



EBARA Stainless Steel Centrifugal Pumps

Model 3U

Dimensions

3U Type 1

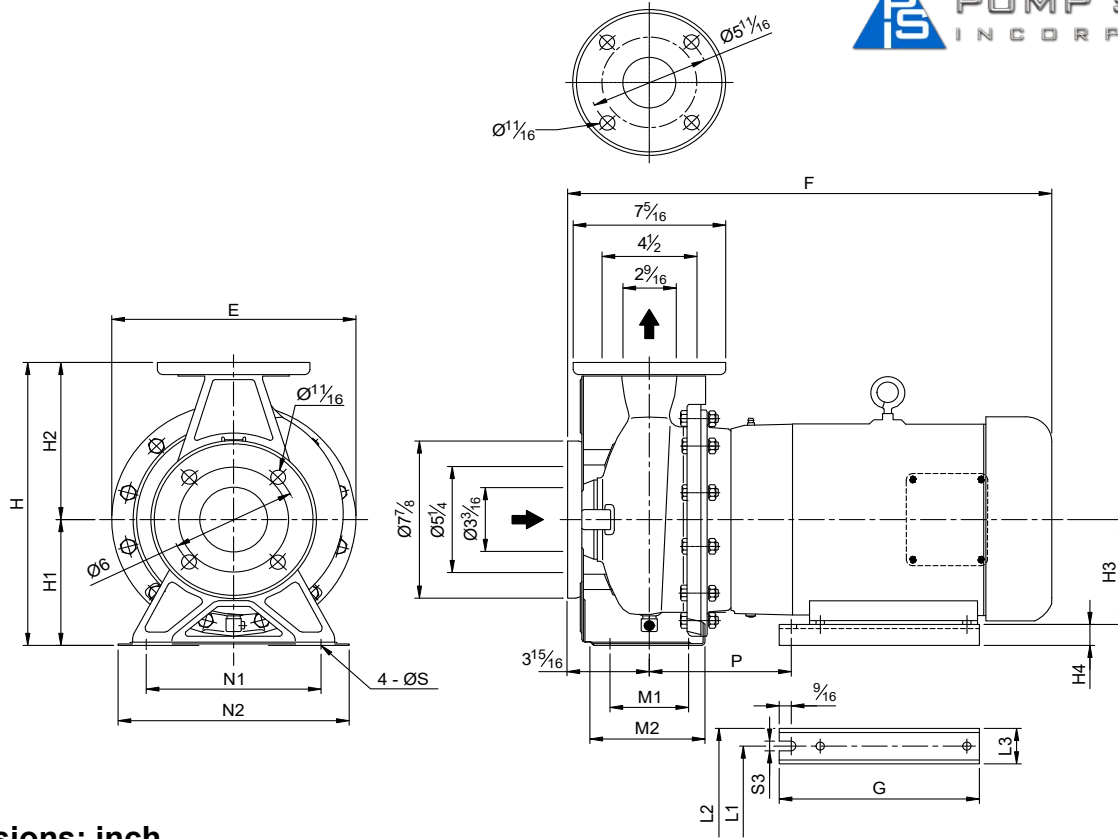

Dimensions: inch

Model	Size	Type	E	F	G	H	H ₁	H ₂	H ₃	H ₄	L ₁	L ₂	L ₃	M ₁	M ₂	N ₁	N ₂	P	S	S ₃
3U 65-125/7.5	2½ x 3 x 4¾	1	10	23¾	9¾	13¾	6½	7½	5¼	1¼	8½	10¼	1¾	3¾	5½	8¾	11	16¾	¾	½
3U 65-125/10	2½ x 3 x 5¾	1	10	23¾	9¾	13¾	6½	7½	5¼	1¼	8½	10¼	1¾	3¾	5½	8¾	11	16¾	¾	½
3U 65-125/15	2½ x 3 x 5½	1	10	30½	9¾	13¾	6½	7½	5¼	1¼	8½	10¼	1¾	3¾	5½	8¾	11	16¾	¾	½
3U 65-160/10	2½ x 3 x 5¼	1	11½	23¾	9¾	14¾	6½	7¾	5¼	1¼	8½	10¼	1¾	3¾	5½	8¾	11	16¾	¾	½
3U 65-160/15	2½ x 3 x 5¼	1	11½	23¾	9¾	14¾	6½	7¾	5¼	1¼	8½	10¼	1¾	3¾	5½	8¾	11	16¾	¾	½

Illinois Location:
 (847) 841-7867
 860 Church Rd Elgin, IL 61

Minnesota Location:
 (651) 758-7867
 330 Mill Bay South Suite :
 Afton, MN 55001

PumpSupplyInc.com



EBARA Stainless Steel Centrifugal Pumps

Model 3U

Dimensions

3U Type 2
3U Type 3

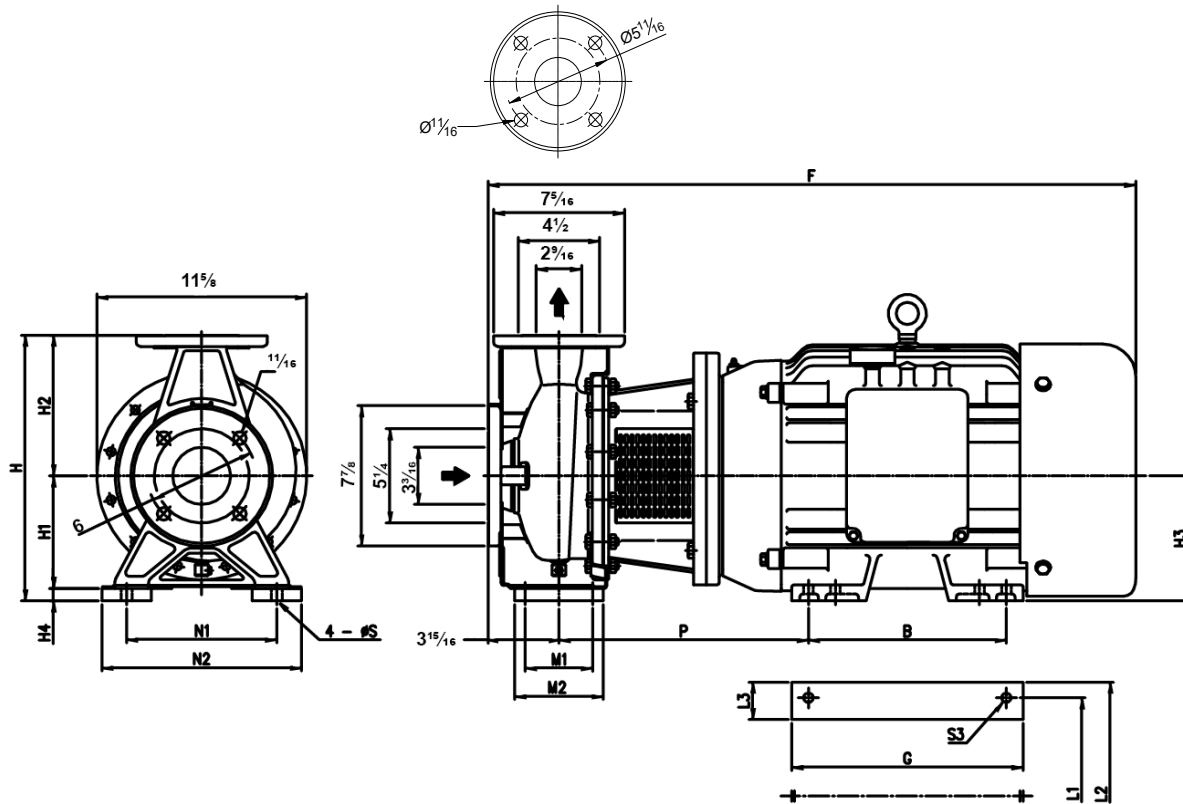

Dimensions: inch

Model	Size	Type	E	F	G	H	H ₁	H ₂	H ₃	H ₄	L ₁	L ₂	L ₃	M ₁	M ₂	N ₁	N ₂	P	S	S ₃
3U 65-125/20	2½ x 3 x 5⅞	3	10	33⅞	11¼	13⅞	6⅞	7⅞	6¼	⅞	10	11⅞	1⅞	3¼	5⅞	8⅞	11⅞	16⅞	⅞	⅞
3U 65-160/20	2½ x 3 x 6⅞	3	11	33½	11¼	14⅞	6⅞	7⅞	6¼	⅞	10	11⅞	1⅞	3¼	5⅞	8⅞	11½	13⅞	⅞	⅞
3U 65-160/25	2½ x 3 x 6⅞	3	11	36	12⅞	14⅞	6⅞	7⅞	7	⅞	11	12¼	-	3¼	4⅞	8⅞	11⅞	13⅞	⅞	⅞
3U 65-200/20	2½ x 3 x 6¼	3	10	32⅞	13⅞	15⅞	7⅞	8⅞	6¼	⅞	10	12⅞	2⅞	3¼	5½	9⅞	12⅞	13⅞	⅞	⅞
3U 65-200/25	2½ x 3 x 7⅞	3	11	36	13	15⅞	7⅞	8⅞	7	⅞	11	12⅞	1⅞	3¼	5½	9⅞	12⅞	13⅞	⅞	⅞

Illinois Location:
(847) 841-7867
860 Church Rd Elgin, IL 60120

Minnesota Location:
(651) 758-7867
330 Mill Bay South Suite
Afton, MN 55001

PumpSupplyInc.com

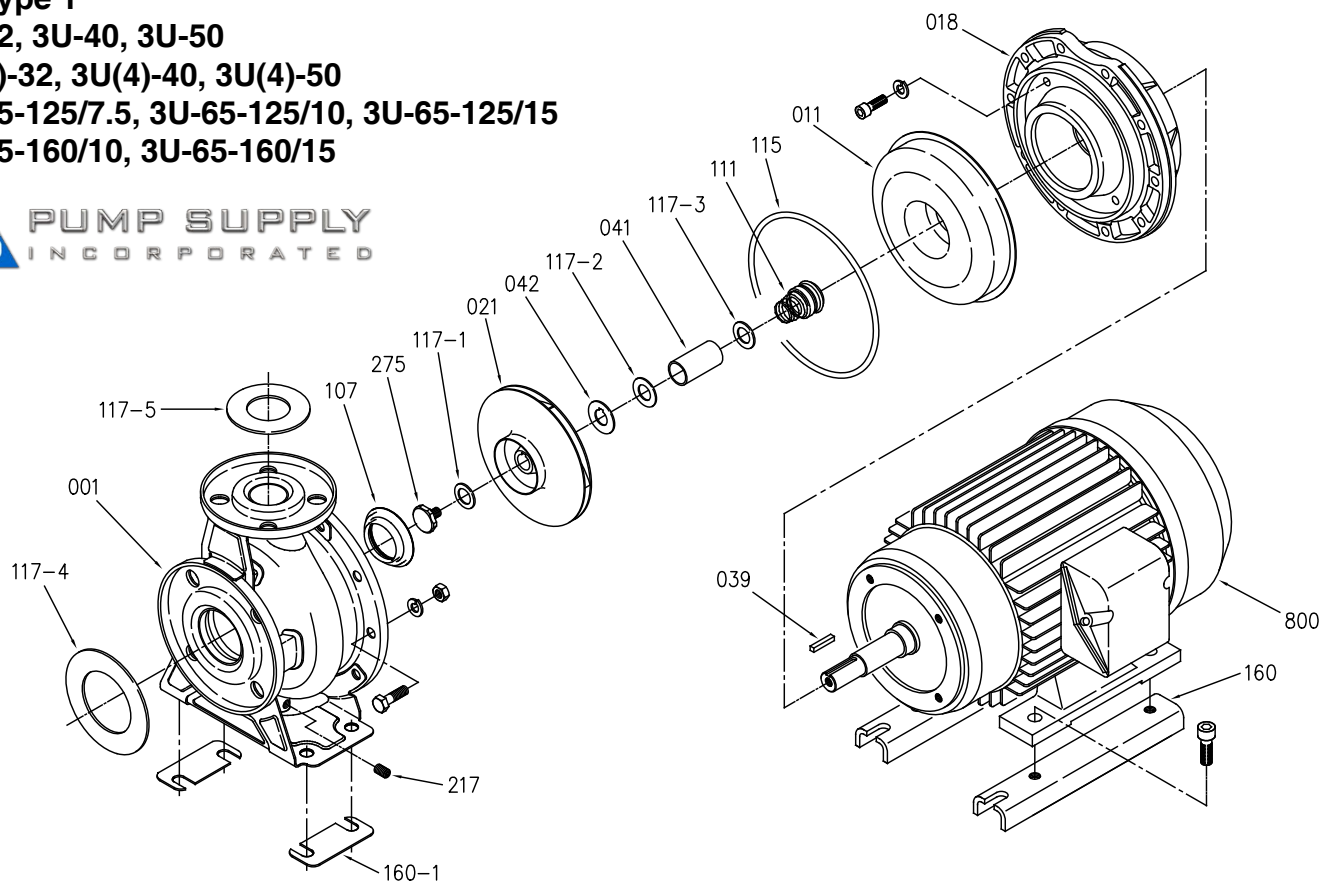

EBARA Stainless Steel Centrifugal Pumps**Model 3U****Sectional View****3U Type 1****3U-32, 3U-40, 3U-50****3U(4)-32, 3U(4)-40, 3U(4)-50****3U-65-125/7.5, 3U-65-125/10, 3U-65-125/15****3U-65-160/10, 3U-65-160/15**

Part No.	Part Name	Materials	No. for 1 Unit
001	Casing	304L Stainless	1
011	Casing Cover	304L Stainless	1
018	Bracket	Cast Iron	1
021	Impeller	304L / 316SS (3U-65 - 316SS)	1
039	Key	304L Stainless	1
041	Shaft Sleeve	304L Stainless	1
042	Impeller Spacer	304L Stainless	1
107	Liner Ring	304L Stainless + PTFE	1
111	Mechanical Seal	varies by model	1
115	O-Ring	Viton/EPDM	1
117-1	Gasket	Nylon	1
117-2	Gasket	Nylon	1
117-3	Gasket	Nylon	1
117-4	Suction Flange Gasket	EPDM	2
117-5	Discharge Flange Gasket	NBR/EPDM	2
160	Motor Support	Steel	2
160-1	Casing Support	Steel	2
217	Drain Plug	304L Stainless	1
275	Impeller Bolt	304L Stainless	1

Pump will use either motor supports or casing supports, depending on model.

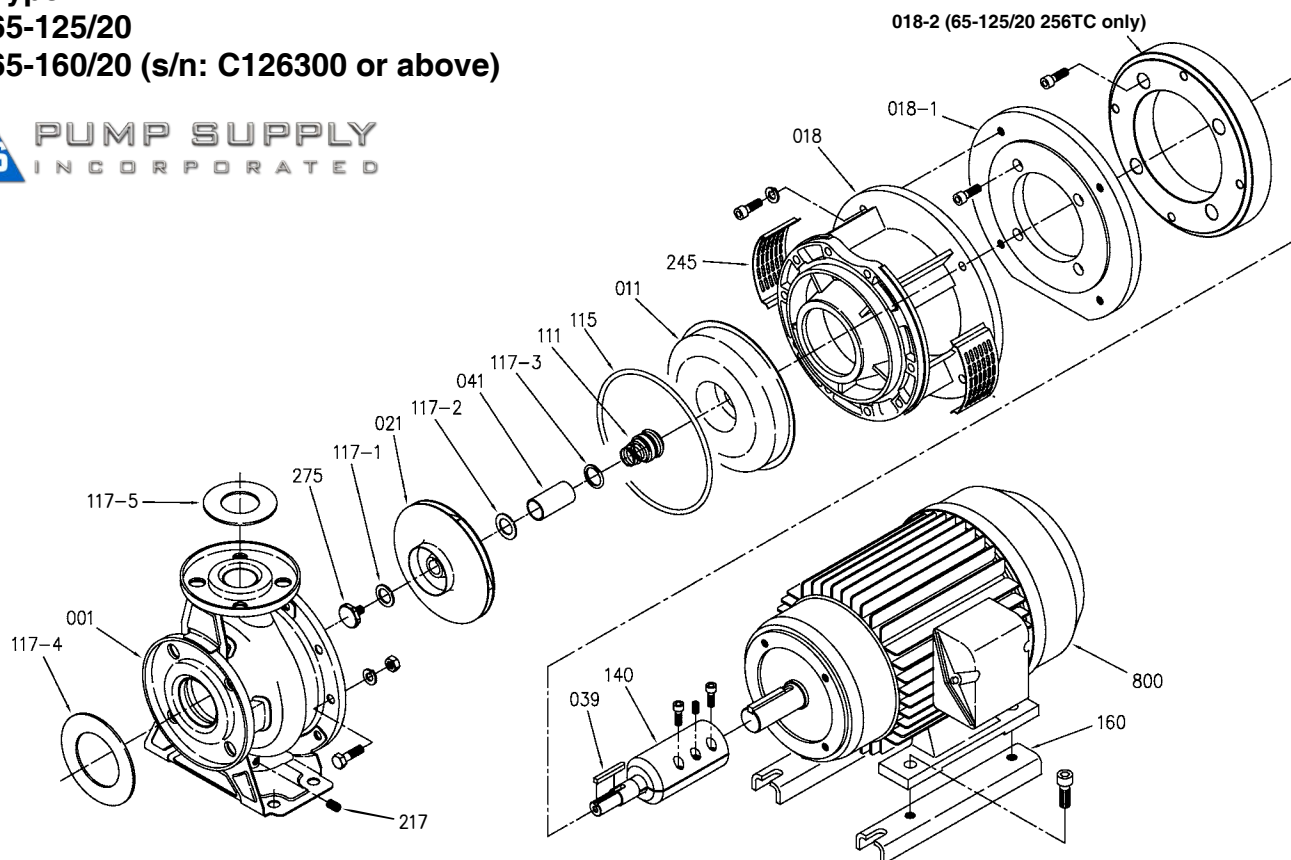

EBARA Stainless Steel Centrifugal Pumps**Model 3U****Sectional View****3U Type 2****3U-65-125/20****3U-65-160/20 (s/n: C126300 or above)**

Part No.	Part Name	Materials	No. for 1 Unit
001	Casing	304L Stainless	1
011	Casing Cover	304L Stainless	1
018	Bracket	Cast Iron	1
018-1	Adapter Ring	Cast Iron	1
018-2	Adapter Ring (65-125 20hp only)	Cast Iron	1
021	Impeller	316 Stainless	1
039	Key	304L Stainless	1
041	Shaft Sleeve	304L Stainless	1
111	Mechanical Seal	varies by model	1
115	O-Ring	Viton/EPDM	1
117-1	Gasket	Nylon	1
117-2	Gasket	Nylon	1
117-3	Gasket	Nylon	1
117-4	Suction Flange Gasket	EPDM	2
117-5	Discharge Flange Gasket	NBR/EPDM	2
140	Coupling	304L Stainless	1
160	Motor Support	Steel	2
217	Drain Plug	304L Stainless	1
245	Coupling Guard	Stainless Steel	2
275	Impeller Bolt	304L Stainless	1
800	Motor	-	1



EBARA Stainless Steel Centrifugal Pumps**Model 3U****Sectional View****Model 3U 65 Type 3**

3U 65-160/20 256TC frame (s/n C1-C126299)

3U 65-160/25 284TSC frame

3U 65-200/20 256TC frame

3U 65-200/25 284TSC frame

3U 65-200/30 284TSC frame

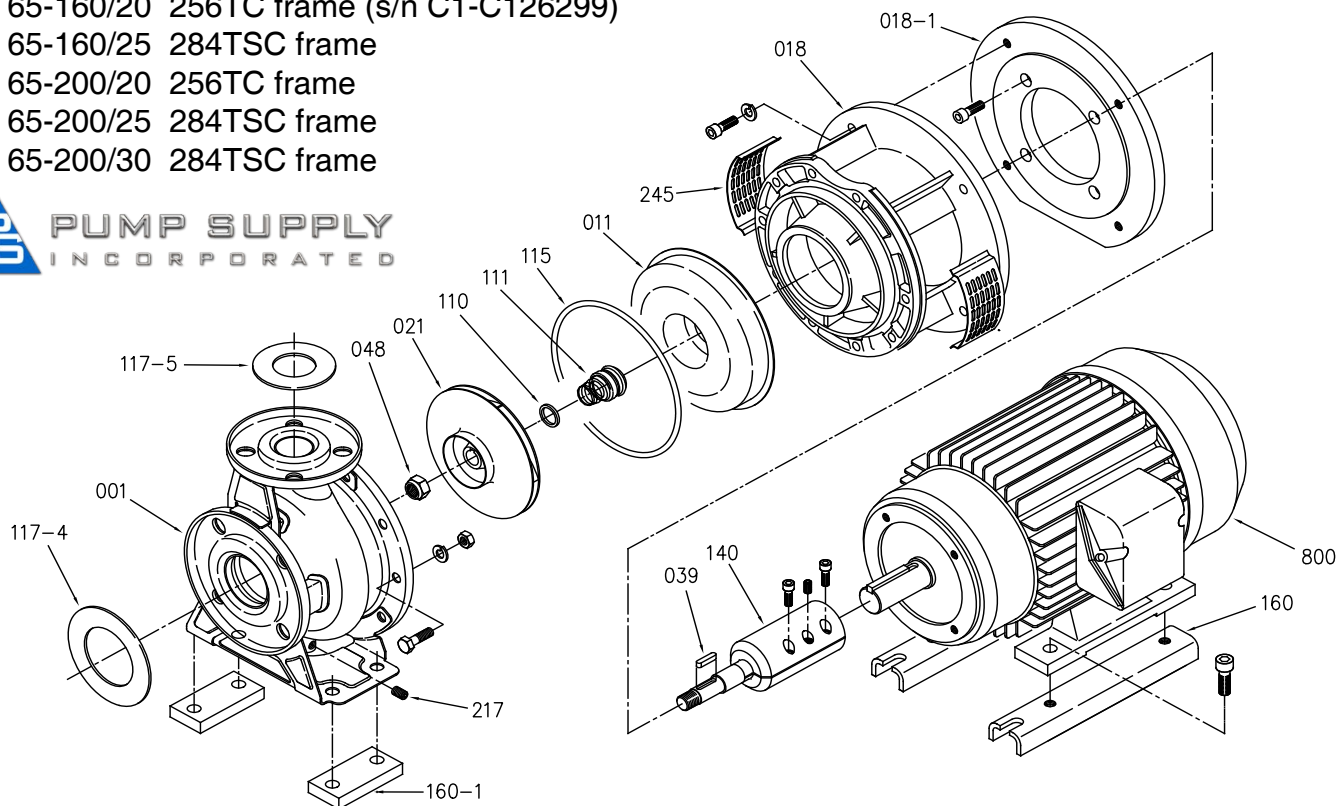

Part No.	Part Name	Materials	No. for 1 Unit
001	Casing	304L Stainless	1
011	Casing Cover	304L Stainless	1
018	Bracket	Cast Iron	1
018-1	Adapter Ring	Cast Iron	1
021	Impeller	316 Stainless	1
039	Key	304L Stainless	1
048	Impeller Nut	Stainless Steel	1
110	Lip Seal	304L Stainless	1
111	Mechanical Seal	varies by model	1
115	O-Ring	Viton/EPDM	1
117-4	Suction Flange Gasket	EPDM	2
117-5	Discharge Flange Gasket	NBR/EPDM	2
140	Coupling	304L Stainless	1
160	Motor Support	Steel	2
160-1	Casing Support	Steel	2
217	Drain Plug	304L Stainless	1
245	Coupling Guard	Stainless Steel	2
800	Motor	-	1

Pump will use either motor supports or casing supports, depending on model.