

Please read and save this Repair Parts Manual. Read this manual and the General Operating Instructions carefully before attempting to assemble, install, operate or maintain the product described. Protect yourself and others by observing all safety information. The Safety Instructions are contained in the General Operating Instructions. Failure to comply with the safety instructions accompanying this product could result in personal injury and/or property damage! Retain instructions for future reference. AMT reserves the right to discontinue any model or change specifications at any time without incurring any obligation.

©2021 AMT Pump Company, A Subsidiary of The Gorman-Rupp Company, All Rights Reserved.

Periodic maintenance and inspection is required on all pumps to ensure proper operation. Unit must be clear of debris and sediment. Inspect for leaks and loose bolts. Failure to do so voids warranty.

2-Inch Thermoplastic Dewatering Pumps



Refer to pump manual 1808-633-00 for General Operating and Safety Instructions.

DESCRIPTION

These centrifugal pumps include a EPDM/EPR mechanical seal with stainless steel spring, O-rings and a built-in check valve for better self-priming capabilities (up to 20 ft. suction lift). Clog resistant impeller is capable of handling solids up to 7/16" diameter. Pumps include molded carrying handle, and two 2" NPT pipe nipples (optional rubber foot pads available). Handle liquids from 40° to 130° F (4° to 54° C). For use with nonflammable, non-abrasive liquids compatible with pump component materials.

Applications include pumping clear, clean water, salt water, and some liquid fertilizers and herbicides. An optional EPDM Seal/O-ring/Flapper Kit (see Repair Parts List) is available for pumping "Alachlor Herbicides" (such as Monsanto's Lasso). If the fertilizer or herbicide is not compatible with Buna-N (standard) or EPDM (optional) rubber materials, do not use these pumps.

For use with nonflammable liquids that are chemically compatible with pump component materials.

IMPORTANT: Not for use with petroleum based liquids.

MAINTENANCE

⚠ WARNING

To prevent accidental starting always remove spark plug, or disconnect and ground spark plug wire before attempting to service or remove any component.

MECHANICAL SEAL REPLACEMENT

Refer to Figures 1, 2, and 3.

IMPORTANT: Replace seal seat, (Ref. No. 22) and seal head (Ref. No. 23) at the same time to ensure proper mating of mechanical seal components!

1. Unthread fasteners (Ref. No. 16), nuts (Ref. No. 25) and remove casing (Ref. No. 15) and casing seal (Ref. No. 7) from adapter (Ref. No. 3). Unthread fasteners (Ref. Nos. 11 and 19) and remove volute (Ref. No. 20) and volute seal (Ref. No. 6) from adapter.
2. Unthread impeller fastener (Ref. No. 10) and remove impeller (Ref. No. 9), impeller seal (Ref. No. 4) and shims (Ref. No. 21).

NOTE: To keep shaft from turning, hold impeller while unthreading impeller fastener.

3. Pry seal seat from impeller recess with a screwdriver (See Figure 1).
4. Remove adapter by unthreading adapter fasteners (Ref. No. 5) and fastener seals (Ref. No. 4). Press old seal head and adapter seal (Ref. No. 24) out of adapter by pushing from engine side.
5. Clean adapter and impeller seal recesses
6. Carefully wipe polished surface of new seal seat with a clean cloth.
7. Wet rubber portion of seal seat with a light coating of soapy water.
8. Press seal seat squarely into recess in impeller. If seal seat does not press squarely into recess, it can be adjusted by pushing on it with a piece of pipe. Always use a piece of cardboard between pipe and seal seat to avoid scratching lapped, highly polished surface of seal seat (handle it carefully).

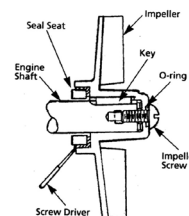

Figure 1 - Mechanical Seal Replacement

9. After seal seat is in place, ensure that it is clean and has not been marred.
10. Using a clean cloth, wipe shaft and make certain that it is completely clean.
11. Place adapter seal (O-ring) onto seal head behind flange and press assembly into adapter as shown in Figure 2.

⚠ CAUTION

Do not touch or wipe polished face of seal head.

12. Secure adapter on pedestal mounting face, using fasteners and fastener seals. Be sure to replace gasket (Ref. No. 31) between engine and adapter, if removed during disassembly.

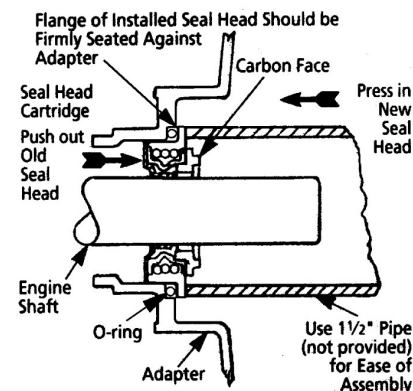

Figure 2 - Mechanical Seal Replacement

IPT Series 2P5X, 2P5XC, 2S5X, 2S5XC & 3S5X Pumps

▲ CAUTION

Tighten adapter fasteners evenly to avoid cocking or damaging adapter.

13. Replace impeller and shims, ensuring that key (Ref. No. 8) is in place and lock impeller to shaft with fastener and impeller seal on fastener.
14. Replace volute seal and volute with fasteners, ensure that check valve (Ref. No. 12) is in place then remount casing seal and pump casing with fasteners and nuts.

IMPORTANT: Always inspect all seals when unit is disassembled. Replace when rubber is hard, cracked, or worn.

When reassembling parts with O-ring seals or gaskets, it is sometimes helpful to apply a small amount of soapy water on O-ring so that parts slide over O-ring without pinching or shaving it.

SHIM ADJUSTMENT

When installing a replacement impeller or mechanical seal, it may be necessary to vary the number of shims (Ref. No. 21) that will be required. This is easily done by adding one 0.010" shim more than was removed and reassembling pump as described.

Ensure that casing is snugly in place and check shaft to make sure it is turning freely. If it turns freely, check to ensure that adapter (Ref. No. 3) and casing (Ref. No. 15) are fitted tight together. If they are not, tighten fasteners (Ref. No. 16) and recheck shaft for free turning. Tighten carefully, turning shaft while tightening. If shaft seizes before fasteners (Ref. No. 16) are completely tight, disassemble pump and remove one shim and repeat reassembly.

If any time during above operation shaft does not turn free, follow procedure indicated above and repeat procedure.

Above procedure ensures that pump will have proper running clearance (less than 0.010") between impeller and casing and perform like a new unit with new impeller or motor.

Illinois Location:
(847) 841-7867
860 Church Rd Elgin, IL 60120

Minnesota Location:
(651) 758-7867
330 Mill Bay South Suite :
Afton, MN 55001

PumpSupplyInc.com





PUMP SUPPLY
INCORPORATED

IPT Series 2P5X, 2P5XC, 2S5X, 2S5XC & 3S5X Pumps

For Repair Parts contact dealer where pump was purchased.

Please provide following information:

-Model Number

-Serial Number (if any)

Part description and number as shown in parts list

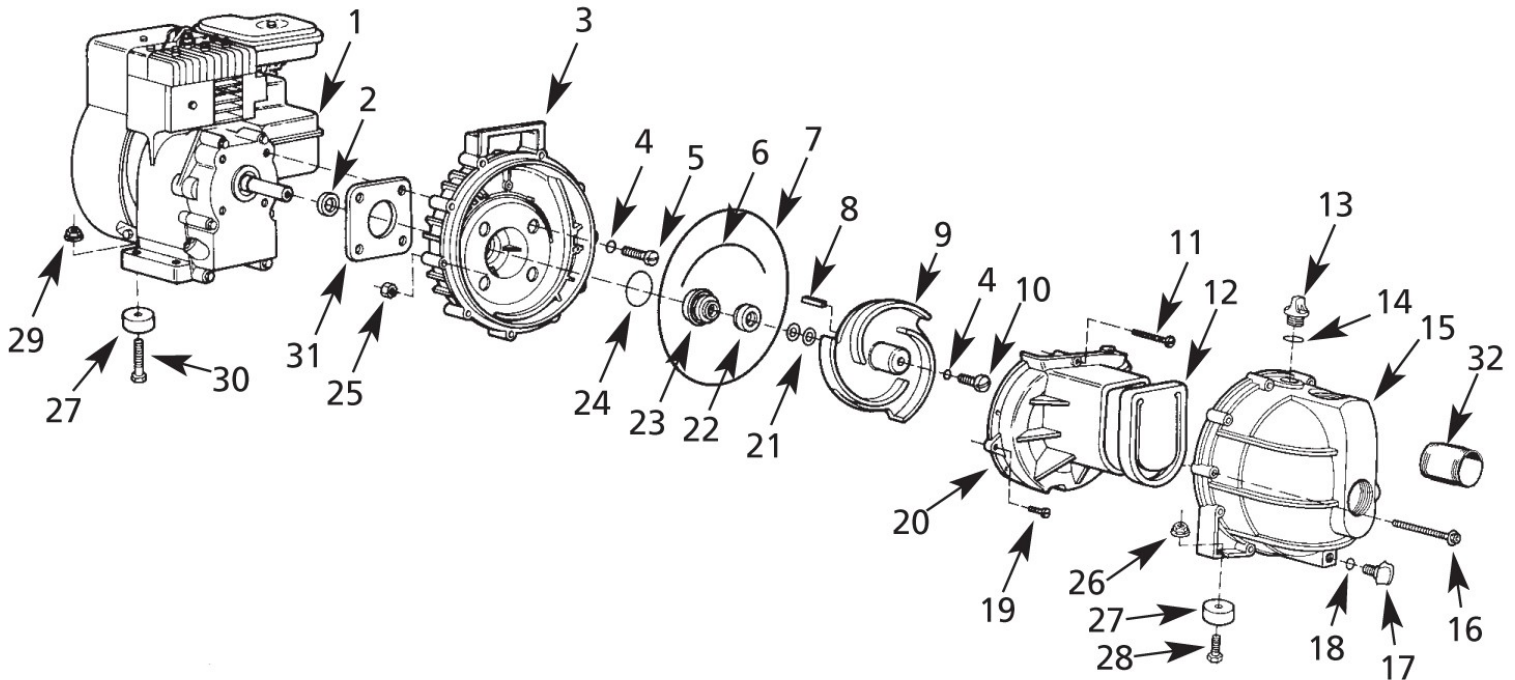

Figure 3 - Repair Parts Illustrations

<p>Illinois Location: (847) 841-7867 860 Church Rd Elgin, IL 60120</p>	
<p>Minnesota Location: (651) 758-7867 330 Mill Bay South Suite Afton, MN 55001</p>	
<p>PumpSupplyInc.com</p>	

PUMP SUPPLY
INCORPORATED

Repair Parts List

Ref. No.	Description	2AG5LPE	Qty. Req'd
1	Engine	1630-070-00	1
2	Slinger Washer - Buna-N	2102-000-00	1
3	Adapter (includes Ref. Nos. 3 & 5)	3827-033-99	1
4	Fastener Seal - EPDM/EPR	Incl. w/Ref KIT	5
5	Adapter Fastener	Incl. w/Ref KIT	4
6	Volute Seal - EPDM/EPR	Incl. w/Ref KIT	1
7	Casing Seal - EPDM/EPR	Incl. w/Ref KIT	1
8	Key	Incl. w/Ref 9	1
9	Impeller Kit (includes Ref. Nos. 8, 9, 10 & 21)	3827-013-99	1
10	Impeller Fastener	Incl. w/Ref 9	1
11	Volute Fastener	Incl. w/Ref 19	1
12	Flapper Valve - EPDM/EPR	3827-070-00 & Incl. w/Ref KIT	1
13	Fill Plug	3827-176-00 & Incl. w/Ref 15	1
14	Fill Plug Seal - EPDM/EPR	Incl. w/Ref KIT	1
15	Casing Kit (includes Ref. Nos. 13, 15, 16, 17 & 25)	3827-003-90	1
16	Fastener	Incl. w/Ref 15	10
17	Drain Plug	3827-177-00 & Incl. w/Ref 15	1
18	Drain Plus Seal - EPDM/EPR	Incl. w/Ref KIT	1
19	Volute Fastener	Incl. w/Ref 19	2
20	Volute Kit (includes Ref. Nos. 11, 19 & 20)	3827-151-90	1
21	Impeller Shim Set	3827-172-90 & Incl. w/Ref 9	1
22 & 23	Shaft Seal Assembly - EPDM/EPR	1640-162-93	1
24	Adapter Seal - EPDM/EPR	Incl. w/Ref KIT	1
25	Nut	Incl. w/Ref 15	10
26	Nut (optional)	*	2
27	Rubber Foot (optional)	1508-000-00	4
28	Fastener (optional)	*	2
29	Nut (optional)	*	2
30	Fastener (optional)	*	2
31	Gasket	Incl. w/Ref KIT	1
32	2" NPT Pipe Nipple Kit	1695-064-90	1
KIT	Seal Kit - EPDM/EPR (standard)	3827-301-91	1
	Seal Kit - Buna-N (optional)	3827-300-91	1
	(includes Ref. Nos. 4, 6, 7, 12, 14, 18, 22, 23, 24 & 31)		

(*) Standard HARDware Item, Available Locally

Illinois Location:
 (847) 841-7867
 860 Church Rd Elgin, IL 60120

Minnesota Location:
 (651) 758-7867
 330 Mill Bay South Suite :
 Afton, MN 55001

PumpSupplyInc.com



NOTES:

<p>Illinois Location: (847) 841-7867 860 Church Rd Elgin, IL 60120</p>	
<p>Minnesota Location: (651) 758-7867 330 Mill Bay South Suite Afton, MN 55001</p> <p>PumpSupplyInc.com</p>	



AMT Pump Company
(herein "AMT")
400 Spring Street
Royersford, PA 19468
Phone: (610) 948-3800
Fax: (610) 948-5300
www.amtpump.com

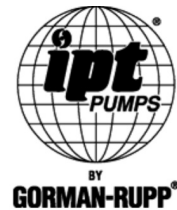

General Information

SALES POLICY: AMT products are sold through our established Distributors. We do not sell direct to the consumer or organization not entitled to trade recognition. Therefore, possession of our catalogs and/or price list(s) does not infer an offer to sell.

MINIMUM ORDER: We appreciate your order, however, all orders are subject to a minimum \$35.00 net invoice charge (excluding freight). This applies to all pump and parts purchase orders.

PRICES: Prices are subject to change without notice. All orders accepted are subject to prices in effect at time of shipment.

PAYMENT TERMS: Terms, upon establishment of credit, are Net 30 days. Past due accounts may be subject to a service charge of 1.5% per month. Domestic or assignable letter of credit is required for all export trade.

PAST DUE ACCOUNTS: AMT reserves the right to withhold open account shipments on any past due account. Invoices are considered past due after thirty (30) days. In the interest of sound business, all orders are subject to approval of the Credit Department.

SHIPPING INSTRUCTIONS: All shipments will be made F.O.B. the factory. Where instructions for shipment do not appear on the order, the shipment will be made according to our best judgment. Full risk of loss (including transportation delays and losses) shall pass to the customer upon delivery of the products to the carrier at the F.O.B. point. When loss or delay occurs, primary responsibility for tracing rests with the customer. When there is LOSS or APPARENT VISIBLE DAMAGE to a shipment, when tendered for delivery, *DO NOT* give the carrier a clear receipt. Note such damage on the carrier's delivery receipt and *HAVE THE DRIVER SIGN THE RECEIPT.*

PRODUCT REVISIONS: AMT reserves the right to discontinue, change or improve its products or any portions thereof without being obligated to provide such a change or improvement for units sold and/or shipped prior to such a change or improvement.

LEAD TIME: Products designated "Quick Ship Product", also referred to as "QSP" will normally be shipped within 24 hours of receipt of a non-cancellable purchase order. Only limited quantities of "QSP" pumps are available.

STANDARD LEAD TIME: Lead time is two weeks for all non "QSP" product. AMT reserves the right to revise lead times as required due to availability of materials and all other causes beyond our control.

VIP SHIPMENT: Select AMT and IPT branded pumps are available for next day shipment for non-QSP (Quick Ship Products) items and subjected to a specific model surcharge per unit noted in the respective price book. Requires calling for availability, confirmation and a non-cancellable purchase order or credit card payment prior to shipment. The expedited shipping charges are an additional cost added separately from the VIP charges per item. AMT reserves the right to revise lead times as required due to availability of materials and all other causes beyond our control. QSP quantities are limited as determined by AMT.

ALL purchase orders must be submitted via hard copy sent to AMT customer service department by fax, EDI or e-mail.

RETURN GOODS POLICY: Goods shall not be returned without a return goods authorization number (RGA) issued by AMT customer service. The RGA number must be listed on the packing list. Only current model and part numbers with a valid date code may be returned (within one year from date of purchase). **A 20% restocking and packaging charge will apply to all returns. All shipping charges must be pre-paid. No exceptions.**

ORDER CHANGES BY CUSTOMER: Orders in process may not be changed except with written consent and may be subject to special charges.

12 Month Limited Warranty

EXTENT AND DURATION OF LIMITED WARRANTY

Coverage: AMT Pump Company (herein "AMT") or IPT Pumps by Gorman-Rupp (herein "IPT") or Gorman-Rupp Industries Division of the The Gorman-Rupp Company, Patterson, or the Gorman-Rupp Company (herein referred to as "G-R Unit") each individually warrants that its products and parts shall be free from defects in material and workmanship for twelve (12) months from the date of purchase by the original end user when installation is made and maintenance is performed in accordance with G-R Unit's recommendations. Wear and tear resulting from use and items normally consumed in use are not covered.

EXCEPTIONS

(A) This Limited Warranty shall not apply to mechanical seals in AMT or IPT pumps and the following products and parts: engines, motors, trade accessories and all other products, components, parts and materials not manufactured by the G-R Units. These items may, however, be covered by the warranties of their respective manufacturers. (B) This warranty does not extend to or apply to any unit which has been repaired or altered at any place other than by a G-R Unit, or by persons not expressly approved by a G-R Unit to make repairs or alterations, nor to any unit the serial number, model number or identification of which has been removed, defaced or altered. (C) This warranty does not extend to any product manufactured by a G-R Unit, which has been subjected to mis-use, neglect, accident, improper installation, or use in violation of instructions furnished by a G-R Unit. (D) Pump Kits: This warranty does not extend to any product sold by a G-R Unit unassembled as a Pump Kit. Pump Kits are warranted against defects in material and workmanship for 60 days from the date of shipment from a G-R Unit. Any Pump Kit parts deemed defective by a G-R Unit will be replaced free of charge within 60 days of shipment. Pump Kits are not returnable for credit.

LIMITATIONS

THE G-R UNITS' SOLE AND EXCLUSIVE WARRANTY WITH RESPECT TO THEIR PRODUCTS AND PARTS IS THIS LIMITED WARRANTY. THIS LIMITED WARRANTY IS IN LIEU OF ALL OTHER EXPRESS AND/OR IMPLIED WARRANTIES, INCLUDING IMPLIED WARRANTIES OF MERCHANTABILITY AND FITNESS FOR PARTICULAR PURPOSE.

EXCLUSIVE REMEDY AND DAMAGES

The sole and exclusive remedy for breach of this Warranty by a G-R Unit and the entire extent of its liability for such breach or for damages arising from the use of the products and parts covered under this Limited Warranty, shall be as follows:



1. **Repair or Replacement:** If inspection shows that any G-R Unit product or part covered under this Limited Warranty is defective in materials or workmanship, the G-R Unit shall repair or replace the defective or non-conforming product or part without charge, whichever the G-R Unit chooses. You must have properly maintained and used the product or part claimed to be defective in accordance with the maintenance schedule or manual, which comes with the product. No allowance will be made for labor, installation, removal, transportation or other charges incurred by you in connection with such repair or replacement.
2. To obtain the above remedy:
 - A. Immediately notify the G-R Unit upon discovery of the claimed defect in materials or workmanship and provide the serial number or date code of the product and/or part(s) or provide the G-R Unit with the invoice or bill of sale referencing the product by no later than the expiration date of the warranty period.
 - B. The G-R Unit will advise whether inspection will be necessary and how whether repair or replacement will be made. If inspection by the G-R Unit is necessary, the pump or defective part must be sent freight pre-paid to the G-R Unit. Return shipment will be F.O.B. the G-R Unit's plant.
 - C. **Return Goods Authorization Requirement:** No product will be accepted for return or replacement without the prior written authorization of the G-R Unit. Upon such authorization, and in accordance with instructions from the G-R Unit, the product will be returned to the G-R Unit, shipping charges prepaid by the Buyer.
3. **Damages:** The G-R Unit's liability for damages for breach of this Limited Warranty shall not exceed the amount of the purchase price of the product or part(s) in respect to which Such damages are claimed. **IN NO EVENT SHALL THE G-R UNITS BE LIABLE FOR INCIDENTAL, CONSEQUENTIAL OR SPECIAL DAMAGES FOR BREACH OF THIS LIMITED WARRANTY.**

Some states do not allow the exclusion or limitation of incidental or consequential damages, so the above limitation or exclusion may not apply to you. This Limited Warranty gives you specific legal rights, and you may also have other rights, which vary from state to state.

Illinois Location:
 (847) 841-7867
 860 Church Rd Elgin, IL 60120

Minnesota Location:
 (651) 758-7867
 330 Mill Bay South Suite :
 Afton, MN 55001

PumpSupplyInc.com

A Gorman-Rupp Company

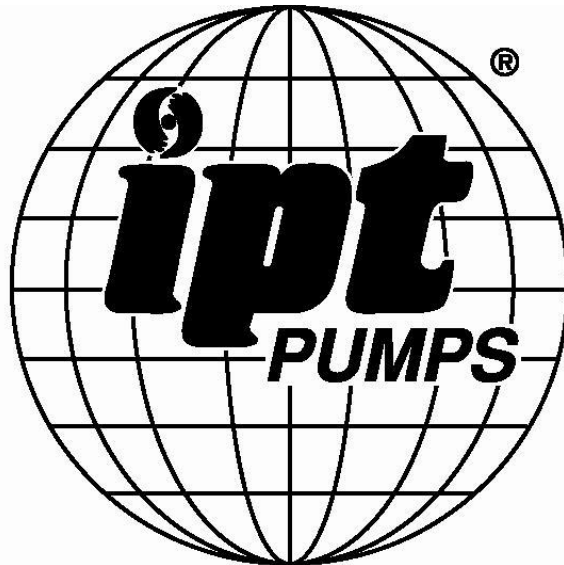

BY
GORMAN-RUPP®

